

1330.01 General	Exhibit 1330-14 Signal Displays for Multiple Turn Lanes
1330.02 Procedures	Exhibit 1330-15 Example Signal Display Placement for Skew Intersection
1330.03 Intersection Design Considerations	Exhibit 1330-16 Signal Display Maximum Heights
1330.04 Conventional Traffic Signal Design	Exhibit 1330-17 Pedestrian Display Placement Requirements
1330.05 Pedestrian Hybrid Beacons and Flashing Beacon Systems (New 2024)	Exhibit 1330-18 PPB Placement Requirements
1330.06 Preliminary Signal Plan	Exhibit 1330-19 PPB Placement on Vertical Shaft Poles
1330.07 Operational Considerations for Design	Exhibit 1330-20 PPB Placement on Large Signal Standards
1330.08 Documentation	Exhibit 1330-21 PHB Signal Equipment (New 2024)
1330.09 References	Exhibit 1330-22 RRFB System (New 2024)
Exhibit 1330-1 Responsibility for Facilities	Exhibit 1330-23 FB System Pole Placement (New 2024)
Exhibit 1330-2 Example Continuous Green “T” Intersection Layout	Exhibit 1330-24 Typical Roundabout FB Pole Placement (New 2024)
Exhibit 1330-3 Left-Turn Lane Configuration Examples	Exhibit 1330-25 Signal Display Surface Areas
Exhibit 1330-4 Recommended Features for Intersections near Rail Crossings	Exhibit 1330-26 Timber Strain Pole Classes
Exhibit 1330-5 Standard Intersection Movements, Head Numbers, and Phase Operation	Exhibit 1330-27 Fixed Vehicle Detection Placement
Exhibit 1330-6 Detector Numbering Examples	Exhibit 1330-28 Decision Zone Detection Placement
Exhibit 1330-7 Signal Display Placements – Key to Diagrams	Exhibit 1330-29 Video Detector Placement
Exhibit 1330-8 Signal Displays for Single Lane Approach	Exhibit 1330-30 Signal Display Layout for Rail Crossings
Exhibit 1330-9 Signal Display Mounting Locations for Multi-Lane Approaches	Exhibit 1330-31 Conduit and Conductor Sizes
Exhibit 1330-10 Signal Displays for Dedicated Left Turn Lanes	Exhibit 1330-32 Phase Diagrams: Four-Way Intersections
Exhibit 1330-11 Signal Displays for Shared Through-Left Lanes – Multiple Through Lanes	Exhibit 1330-33 Phase Diagrams: Three-Way Intersections
Exhibit 1330-12 Signal Displays for Shared Through-Right Lanes	Exhibit 1330-34 Phasing at Railroad Crossings
Exhibit 1330-13 Signal Displays for Dedicated Right Turn Lanes	

1330.01 General

Traffic control signals are automated traffic control devices that warn or direct motorists to take a specific action. Traffic control signals are used to control the assignment of right of way at locations where conflicts with motorists, bicyclists, and pedestrians exist or where passive devices such as signs and markings do not provide the necessary flexibility of control to move motorists, bicyclists, and pedestrians in an efficient manner.

The decision to install a traffic signal is the result of an Intersection Control Evaluation (ICE) (see [Chapter 1300](#)) that is approved by the Region Traffic Engineer or other designated authority.

1330.02 Procedures

1330.02(1) Traffic Signal Permit

State statutes (RCWs) require WSDOT approval for the design and location of all conventional traffic signals and some types of beacons located on city streets forming parts of state highways.

Approval by WSDOT for the design, location, installation, and operation of all other traffic control signals installed on state highways is required by department policy.

The Traffic Signal Permit ([DOT Form 242-014 EF](#)) is the formal record of the signal warrant analysis required by the MUTCD and the department’s approval of the installation and type of signal. Permits are required for the following types of signal installations:

- Conventional traffic signals
- Emergency vehicle signals
- Intersection control beacons
- Lane control signals
- Movable bridge signals
- Ramp meter signals
- Pedestrian signals
- Pedestrian Hybrid Beacon signals (“HAWK” signals)
- Temporary traffic signals (only when not being used in place of a permanent, permitted signal)

- Queue-cutter traffic signals

The Permit and its supporting data must be included in the Design Documentation Package (DDP.) The permit is completed by the requesting agency and submitted, complete with supporting data, through the Region Transportation Operations Office to the approving authority for approval. See Section [1330.02\(1\)\(a\)](#) for Signal Warrant information required as part of the supporting documentation.

The approving authority is the Regional Administrator or authorized delegate. The approving authority approves or denies the application and sends it back to the Region Transportation Operations Office. The Region Transportation Operations Office retains a record of the approved permit and supporting data and forwards a copy of the Permit and the supporting data to the State Transportation Operations Engineer at WSDOT Headquarters (HQ). Preserve the approved permit as required by Section [1330.08](#) Documentation.

Emergency vehicle signals require annual permit renewal. The Region Transportation Operations Office reviews the installation for compliance with requirements. If satisfactory, the permit is renewed by the Regional Administrator with a letter to the operating agency. A copy of this letter is also sent to the State Transportation Operations Engineer.

Permits are not required for portable traffic signals, speed limit sign beacons, stop sign beacons, or lane assignment signals at toll facilities.

A new permit application is required when the level of control is increased, such as changing from an intersection control beacon to a conventional traffic signal or adding an approach to an existing signal system.

For a reduction in the level of control, such as converting a conventional signal to a flashing intersection beacon or removal of the signal, submit the “Report of Change” portion of the traffic signal permit, complete with supporting data, to the approving authority, with a copy to the Region Transportation Operations Office and State Transportation Operations Engineer.

If experimental systems are proposed, the Region Traffic Engineer’s review and approval is required. The Region Transportation Operations Office will send the approved proposal to the State Transportation Operations Engineer for review and approval. The State Transportation Operations Engineer will forward the approved proposal to FHWA for their approval. A copy of the approval from FHWA will be returned and must be preserved as required by [1330.08](#) Documentation.

Any signal system requiring a permit, with the exception of Ramp Meter signals, also requires Preliminary Signal Plan approval from the WSDOT HQ Transportation Operations Division (see Section [1330.06](#)).

1330.02(1)(a) Signal Warrants

A signal warrant is a minimum condition that is to be met before a signal may be considered for installation. Satisfying a warrant does not mandate the installation of a traffic signal. The warranting condition(s) supports the inclusion of a traffic signal for consideration as part of the ICE performed during the scoping of the project (see [Chapter 1300](#)). For a list of the traffic signal warrants and information on how to use them, see the [Manual on Uniform Traffic Control Devices](#) (MUTCD). Contact the Region Traffic Engineer for region specific practices.

Address all warrants listed in the currently adopted MUTCD as part of the Signal Warrant Analysis. Mark warrants which do not apply as “Not Applicable” and include a basic supporting statement or similar justification. Include the Signal Warrant Analysis in the Signal Permit supporting data. For Warrant 7, the three year period must be used for all traffic signals installed on state highways as described in FHWA Interim Approval IA-19 (https://mutcd.fhwa.dot.gov/resources/interim_approval/ia19/index.htm).

1330.02(2) Responsibility for Funding, Construction, Maintenance, and Operation

Responsibility for the funding, construction, maintenance, and operation of traffic signals on state highways has been defined by legislative action and Transportation Commission resolutions (see [Exhibit 1330-1](#)).

Responsibilities vary depending on location, jurisdiction, and whether or not limited access control has been established. Limited access as used in this chapter refers to full, partial, or modified limited access control that has been established as identified in the [Access Control Tracking System](#). The following is a summary of the typical areas of responsibility:

- a) **Inside the corporate limits of cities with a population of 30,000 or greater where there is no established limited access control:**
The city is responsible for the funding, construction, maintenance, and operation of traffic signals. Population figures can be found at: www.ofm.wa.gov/pop/
- b) **Inside the corporate limits of cities with a population of less than 30,000:**
WSDOT is responsible for funding, construction, maintenance, and operation of traffic signals. Population figures can be found at: www.ofm.wa.gov/pop/
- c) **Inside the corporate limits of cities with a population of 30,000 or greater where there is established limited access control:**
WSDOT is responsible for funding, construction, maintenance, and operation of traffic signals. Population figures can be found at: www.ofm.wa.gov/pop/
- d) **Outside the corporate limits of cities and outside established limited access control areas:**
WSDOT is responsible for funding, construction, maintenance, and operation of a traffic signal when a new state highway crosses an existing county road. When a new county road intersects an existing state highway, WSDOT is responsible for only the maintenance and operation of a traffic signal. The county is responsible for the construction costs of the traffic signal and associated illumination. When it is necessary to construct a traffic signal at an existing county road and state highway intersection, the construction cost distribution is based on the volume of traffic entering the intersection from each jurisdiction's roadway. The county's share of the cost, however, is limited to a maximum of 50%. The state is responsible for maintenance and operation ([WAC 468-18-040](#)).
- e) **Outside the corporate limits of cities and inside established limited access control areas:**
WSDOT is responsible for funding, construction, maintenance, and operation of traffic signals.
- f) **Emergency vehicle signals:**
The emergency service agency is responsible for all costs associated with emergency vehicle signals.
- g) **Third party agreement signals:**
At those locations where WSDOT is responsible for traffic signals and third-party activity justifies the installation of a traffic signal, as determined by an ICE, the following rules apply:
 - The third party is responsible for funding the design and construction of the traffic signal system, unless another arrangement is agreed upon with WSDOT.
 - The third party obtains a traffic signal permit.
 - The third party agrees to design and construct the traffic signal in conformance with WSDOT's guidelines and requirements.
 - The third party agrees to submit the design and construction documents to WSDOT for review and approval by the Region Traffic Engineer.
 - Preserve all third party provided documents and any third-party agreement(s) as required by [Section 1330.08](#) Documentation.

Exhibit 1330-1 Responsibility for Facilities

Responsibility for Various Types of Facilities on State Highways				
Area	Responsibility	Emergency Vehicle Signals	Traffic Signals, Pedestrian Signals, & Intersection Control Beacons	Reversible Lane Signals & Movable Bridge Signals
Cities with a population of 30,000 or greater	Finance	ESD [1]	City [2]	City [2]
	Construct	ESD [1]	City [2]	City [2]
	Maintain	ESD [1]	City [2]	City [2]
	Operate	ESD [1]	City [2]	City [2]
All other locations	Finance	ESD [1]	State/County [3] /Other [4]	State
	Construct	ESD [1]	State/County [3] /Other [4]	State
	Maintain	ESD [1]	State	State
	Operate	ESD [1]	State	State

Notes:

- [1] ESD refers to the applicable Emergency Service Department.
- [2] Does not apply to state highways with established limited access control (see Section 1330.02(2) c).
- [3] Beyond corporate limits due to county activity (see Section 1330.02(2) d).
- [4] Other refers to signals proposed by or required due to third party activity (see Section 1330.02(2) g).

1330.03 Intersection Design Considerations

Signalized intersections require different design considerations than non-signalized intersections. These elements should be considered as early as the ICE process (see [Chapter 1300](#) and [Chapter 1310](#) for further guidance.) This Section discusses basic intersections with relatively simple geometry. For more complex or innovative intersection layouts such as Diverging Diamond Interchanges, Displaced Left Turns, or Single Point Urban Interchanges, contact the WSDOT HQ Transportation Operations Division for support.

Consider providing an unrestricted through lane on the major street of a T intersection (sometimes referred to as a Continuous Green "T" (CGT) intersection).

This design allows for one traffic movement to flow without restriction. When this is used on through roadways with a posted speed of 45 MPH or greater, the through lane must be separated by a physical barrier or the through movement must also be signalized. If there is a crosswalk across the through lane, the through lane must be signalized. [Exhibit 1320-2](#) shows an example of a CGT intersection.

Exhibit 1330-2 Example Continuous Green “T” Intersection Layout

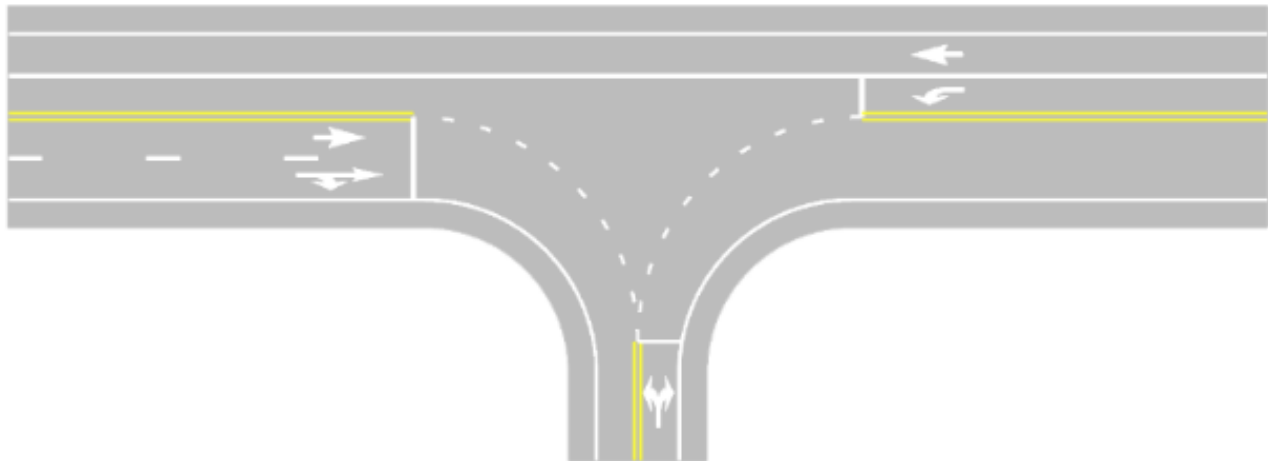

1330.03(1) Left Turns

It is recommended that a left turn storage lane be provided for all main line roadways where left turns are allowed. This helps to avoid having stopped traffic in a through lane with a green through signal display. This also helps to support potential future changes in left turn operations. See Section [1330.07\(1\)](#) for additional discussion.

Left-turning traffic can operate more efficiently when the opposing left-turn lanes are directly opposite each other. When a left-turn lane is offset into the path of an opposing through lane, the left-turning driver may assume the opposing vehicles are also in a left-turn lane and fail to yield. To prevent this occurrence, less efficient split phasing may be necessary. (See [Chapter 1310](#) for guidance on lane offsets and opposing left-turn clearance.) Where there are opposing through lanes but no opposing left turn lane, install a striped or raised median area opposite the left turn lane if possible.

Place stop lines so that they are out of the path of conflicting left turns. Check the geometric layout by using turning templates or a computerized vehicle turning path program (such as AutoTURN®) to determine whether the proposed layout and phasing is sufficient for the design vehicles. Also, check the turning paths of opposing left-turn movements. In many cases, the phase analysis might recommend allowing opposing left turns to run concurrently, but the intersection geometrics are such that this operation cannot occur. The intersection should be large enough to provide opposing left turning vehicle paths with a 4-foot minimum (12-foot desirable) separation between them. Where this separation cannot be achieved, less efficient signal phasing may be required to provide adequate space for opposing left turns.

Some intersections may have multi-lane left turns. At locations with closely spaced intersections, a multi-lane left-turn storage area might be the only solution to reduce the potential for the left-turn volume to back up into an adjacent intersection. As with single left turn lanes, the intersection should be large enough to provide opposing left turning vehicle paths with a 4-foot minimum (12-foot desirable) separation between them. Where this separation cannot be achieved, less efficient signal phasing may be required to provide adequate space opposing left turns.

At smaller intersections, the opposing single-lane left-turn movement might not be able to turn during the two-lane left-turn phase and it might be necessary to reposition this lane.

If the opposing left turns cannot time together, the reduction in delay from the two-lane left-turn phase is likely to be nullified by the requirement for a separate opposing left-turn phase. Exhibit 1330-3 shows two examples of two-lane left turns with opposing single-left arrangements.

Two receiving lanes are required for two-lane left-turn movements. In addition, these receiving lanes are to extend well beyond the intersection before reducing to one lane. A lane reduction immediately beyond the intersection can cause delays and backups into the intersection because the left-turning vehicles usually move in dense platoons, which may make merging and lane changes difficult. (See Chapter 1310 for guidance on lane reductions on intersection exits.)

Exhibit 1330-3 Left-Turn Lane Configuration Examples

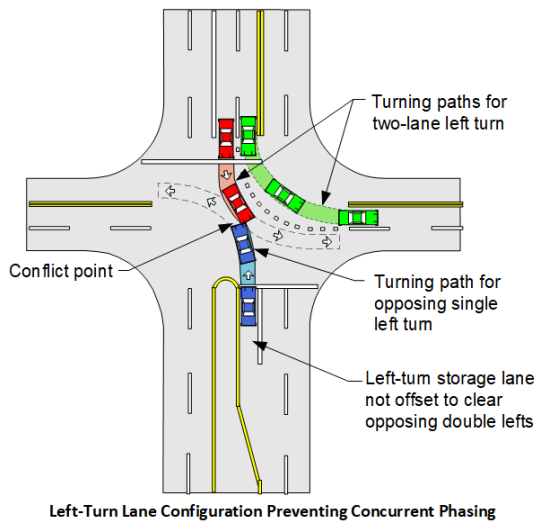

Single left turn lane not offset – overlapping left turn paths

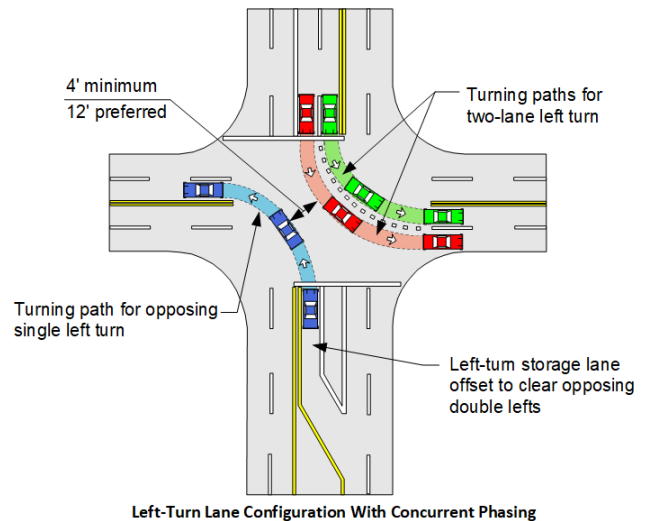

Offset single left turn lane – opposing lefts no longer in conflict

1330.03(2) Right Turns

Large right-turn curb radii at intersections sometimes have impacts on traffic signal operation. Larger radii allow faster turning speeds and might move the pedestrian entrance point farther away from the intersection area. Pedestrian crossing times are increased because of the longer crossing, thereby reducing the amount of time available for vehicular traffic. (See Chapter 1310 for guidance on determining these radii.)

At intersections with large right-turn radii, consider installing raised traffic islands. These islands are primarily designed as pedestrian refuge areas. (See Chapter 1510 for pedestrian refuge islands and traffic island designs.) Traffic islands may decrease the required pedestrian clearance intervals; however, large radii and raised traffic islands may make it difficult for pedestrians to navigate the intersection. Where pedestrians are expected to cross a right turn lane to a traffic island, it is recommended to use a compound right turn-lane design as shown in Chapter 1310.

Where a right turn uses a slip lane at a signalized intersection that either provides a smooth transition into the departing roadway (there is no angle point where the left edge line of the turn lane meets the right edge line of the intersecting roadway) or becomes a new lane on the departing roadway, the right turn slip lane must be signalized if there is a pedestrian crossing. In addition, refer to guidance in Section 1310.02(14) Islands, when considering implementation of a slip lane, or evaluating an existing slip lane.

1330.03(3) Pedestrian Features

See [Chapter 1510](#).

1330.03(4) Road Approaches and Driveways

If roadway approaches and driveways are located too close to an intersection, the traffic from these facilities can affect signal operations. Consider eliminating the accesses or restricting them to “right in/right out”. If a driveway or road approach is directly opposite a leg of the intersection, that approach may be signalized. If the approach is signalized, it must be signalized as if it were a standard intersection leg, and the pedestrian crossing across the approach must also be signalized as if it were a standard crosswalk.

Management of driveways and road approaches should be determined early (preferably no later than scoping) so that they can be considered and addressed in the design. (See [Chapter 530](#) and [Chapter 540](#) for further guidance.) Consider shifting the location of advance detection upstream to clear an access point so that vehicles entering from the access point will not affect detection and operation of the signal.

1330.03(5) Skewed Intersections

Skewed intersections, because of their geometry, are challenging to signalize and delineate. Where feasible, modify the skew angle to provide more normal approaches and exits. In many cases, the large, paved areas for curb return radii at skewed intersections can be reduced when the skew angle is reduced. (See [Chapter 1310](#) for requirements and design options.) Visibility of pedestrians is of particular concern and must also be taken into consideration.

1330.03(6) Transit Stops

Transit stops and pullout locations should be located on the far side of the intersection to minimize their impacts on signal operation. (See [Chapter 1730](#) for transit stop and pullout designs.)

1330.03(7) Railroad Crossings

Where railroad preemption is used at a signalized intersection, install left and right turn lanes for the movements leading to the leg of the intersection with the railroad crossing if possible. This greatly improves the efficiency of the signal during railroad preemption when turns are restricted.

Also consider providing a left-turn lane for the minor leg opposing the railroad crossing. This will allow for more effective signal operations during long periods of railroad preemption.

Where there is less than 40 feet between the nearest rail and the normal location of the stop line, do not install a stop line between the tracks and the intersection. Use the same stop line for the traffic signal and the rail crossing instead. [Exhibit 1330-4](#) shows recommended intersection features for intersections near rail crossings. Contact the WSDOT HQ Transportation Operations Division for assistance with standalone queue-cutter signals.

Exhibit 1330-4 Recommended Features for Intersections near Rail Crossings

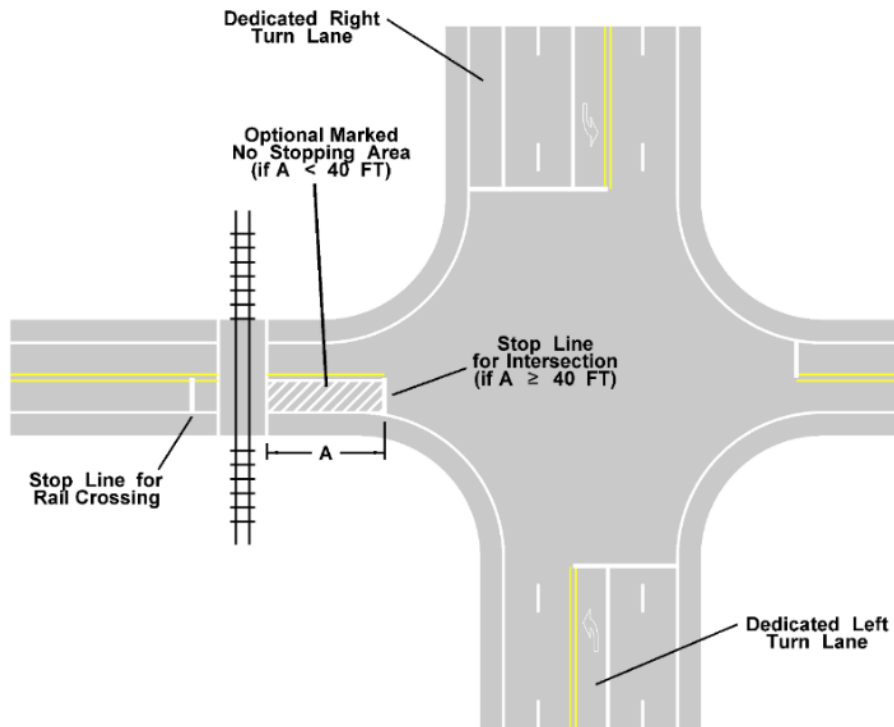

1330.04 Conventional Traffic Signal Design

1330.04(1) General

The goal of any traffic signal design is to assign right of way in the most efficient manner possible and still be consistent with traffic volumes, intersection geometrics, and safety.

An advanced signalized intersection warning sign may be required when the sight distance to the signal is not met. A beacon assembly with the sign to warn motorists of a signalized intersection shall be included when directed by the Region Traffic Engineer if either of the two following conditions exists:

- The visibility requirements in the [MUTCD](#) are not achievable.
- The posted speed is 55 mph or higher and the previous signalized intersection is more than 2 miles away; this does not apply to freeway off-ramps.

This warning sign and beacon assembly consists of a W3-3 sign with Type IV reflective sheeting and one or two continuously flashing beacons.

Where two beacons are used, the beacons should flash alternately instead of simultaneously. Locate the sign in advance of the intersection in accordance with Table 2C-4 (Condition A) of the [MUTCD](#). The warning sign and beacon assembly may be omitted with approval from the Region Traffic Engineer.

1330.04(2) Signal Phasing

With some exceptions, the fewer the traffic signal phases, the more efficient the operation of the traffic signal. The number of phases required for efficient operation is related to intersection geometrics, traffic volumes, composition of traffic flow, turning movement demands, and desired level of driver comfort. The traffic movements at an intersection have been standardized to provide consistency in both traffic signal design and driver expectations. (See Exhibit 1330-5 for standard intersection movements, signal head (display) numbering, and standard phase operation.)

Exhibit 1330-5 Standard Intersection Movements, Head Numbers, and Phase Operation

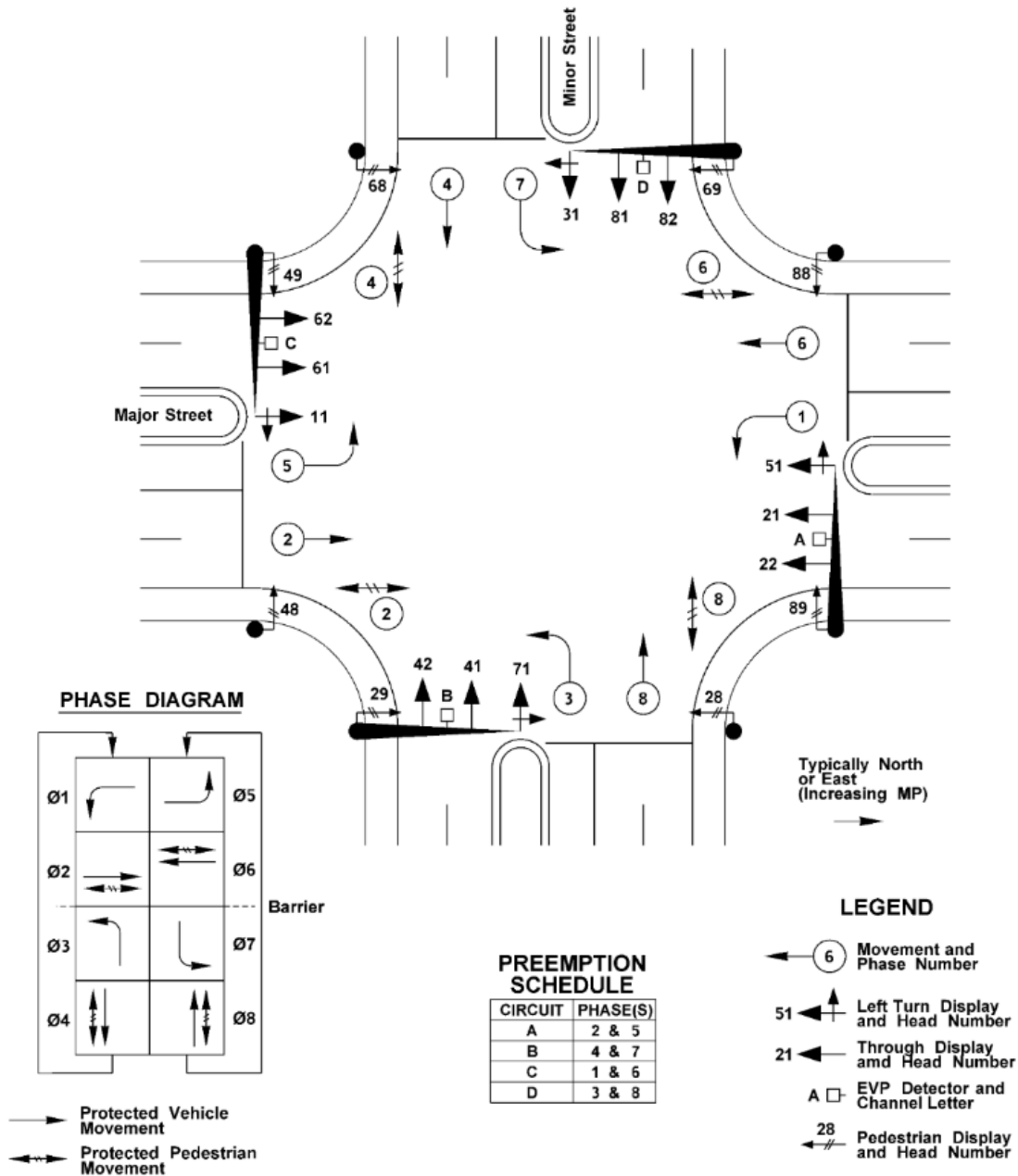

For WSDOT operated signals, the region Signal Operations Engineer will develop the signal phasing plan or review proposed phasing for systems designed by others. For signals operated by other jurisdictions, the operating jurisdiction should be involved in signal phasing development. Phasing development is addressed in Section 1330.07 Operational Considerations for Design. Phasing development should begin as soon as the decision is made to install a traffic signal and may begin as early as the intersection control evaluation. Provide the proposed channelization plans and traffic count data to the region Signal Operations Engineer or phasing designer as early as possible, as phasing information is required to complete the signal system design.

For WSDOT owned and operated signals, vehicle and pedestrian movement phase numbering is standardized to provide uniformity in signal phase numbering, signal display numbering, preemption channel identification, detection numbering, and circuit identification. For signals owned and operated by other jurisdictions, refer to that jurisdiction's guidelines for phase and equipment numbering.

The following are general guidelines for the WSDOT numbering system:

1. Phases 2 and 6 are normally assigned to the major street through movements, with phase 2 assigned to the northbound or eastbound direction of the major street. This results in phase 2 being aligned with the direction of increasing mileposts.
2. Phases 1 and 5 are normally assigned to the major street protected left-turn movements.
3. Phases 4 and 8 are normally assigned to the minor street through movements, with phase 4 normally assigned to the approach to the left of the phase 2 approach (as viewed from the phase 2 stop line).
4. Phases 3 and 7 are normally assigned to the minor street protected left-turn movements.
5. Phasing on new signals installed within an already signalized corridor should be assigned to match the existing corridor phasing – even if it doesn't follow the standard phasing conventions listed above.
6. At T intersections, the movement on the stem of the T is normally assigned to either phase 4 or phase 8. Which phase is used will normally depend on the major street phase assignments.
7. At intersections where split phasing is used (opposing directions time separately) assign phases normally but show the split phase phasing diagram, unless otherwise directed by maintenance and operations staff.
8. Signal displays are numbered as follows:
 - a. The first number indicates the signal phase, and the second number is the number of the signal head, counting from centerline (or left edge line) to the right edge line of the approach. For example, signal displays for phase 2 are numbered, as viewed from left to right, 21, 22, 23, and so on. If the display is an overlap, the designation is the letter assigned to that overlap. For example, signal displays for overlap A are number A1, A2, A3, and so on.
 - b. If the display is protected/permissive, the display is numbered with the phase number of the through display followed by the phase number of the left-turn phase. For example, a protected/permissive signal display for phase 1 (the left-turn movement) and phase 6 (the compatible through movement) is numbered 61/11. For overlap right turns, the protected portion may either be an overlap phase, or it may be the same phase as the complementing left turn phase.
9. With a conventional protected/permissive left-turn display, the circular red, yellow, and green displays are connected to the through phase (phase 6, in this example) controller output and the steady yellow and green arrow displays are connected to the left turn phase (phase 1, in this example) controller output.

10. When a flashing yellow arrow display is used, coordinate with the Signal Operations Engineer and signal maintenance group to determine appropriate wiring. For new cabinets, always specify an auxiliary output rack when protected/permissive phasing will be used.
11. Pedestrian displays and detectors are numbered with the first number indicating the signal phase and the second number as either an 8 or 9. For example, pedestrian displays and detectors 28 and 29 are assigned to phase 2. If there are more than two displays or detectors for a single pedestrian phase, use letter suffixes for additional displays and detectors (28A / 29A, 28B / 29B, etc.).
12. Vehicle detector numbering depends on the type of detection:
 - a. Induction loop detectors use three-digit numbers for designation. The first number represents the phase. The second number represents the lane number, starting from the left lane and moving towards the right edge line. The third number represents the loop number counting from the stop line back. For example, detection loops for phase 2 detectors are numbered 211, 212, 213 for lane 1; 221, 222, 223 for lane 2; and so on. For loops tied together in series for a single detection channel, such as a three-loop series stop line detector, the individual loops in the series use a letter suffix. For a stop line detector in lane 1 for phase 2, using three loops in series, the loops would be designated 211A, 211B, and 211C.
 - b. Video detectors are designated V#, where “#” is the through phase number for that approach, even if it will cover additional phases (such as left turn or overlap) for that approach. If the video detector is for advance detection, the suffix “A” is added. For example, the advance video detector for phase 6 would be V6A.
Video detection zones may be drawn on the contract plans if desired, but these will normally be field established and adjusted and may not end up as shown in the plans. If used, video detection zones are labeled the same as loop detectors, but with a “V” suffix. For example, the stop line video detection zone for phase 5 would be 511V.
 - c. Radar detectors are designated similar to video detectors but use an “R” prefix in place of the “V”. For example, the advance radar detector for phase 4 would be R4A.
 - d. Wireless in pavement sensors use the same numbering scheme as induction loops but add a “W” suffix. For example, the phase 7 stop line sensor would be 711W.
 - e. [Exhibit 1360-6](#) shows examples of standard detector numbering.
13. Emergency vehicle detectors use letter designations: Channel A detectors cover phase 2 and phase 5; Channel B detectors cover phase 4 and phase 7; Channel C detectors cover phase 1 and phase 6; and Channel D detectors cover phase 3 and phase 8. When there are multiple detectors for the same channel, the first detector uses the letter, and all other detectors use a number suffix (C, C1, C2, etc.).

Exhibit 1330-6 Detector Numbering Examples

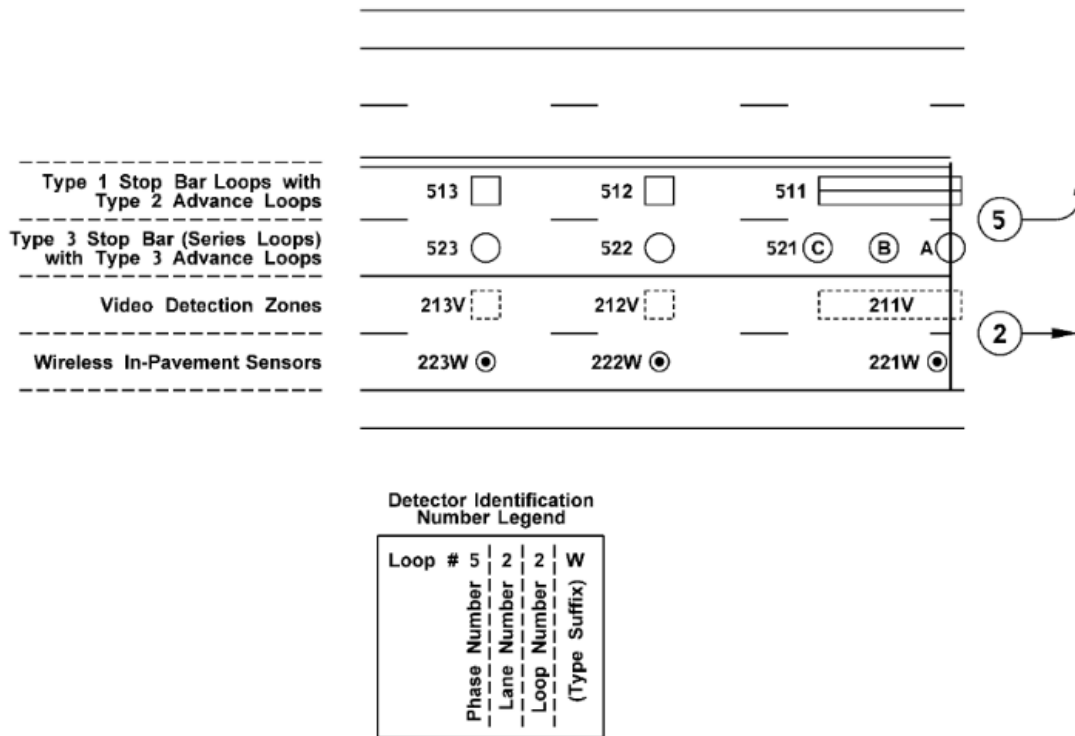

1330.04(3) Vehicle Signal Displays

Signal displays are the devices used to convey right of way assignments and warnings from the signal controller to the motorists and pedestrians. When selecting display configurations and locations, the most important objective is the need to present these assignments and warnings to the motorists and pedestrians in a clear, concise, and uniform manner.

The use of ball, steady arrow, or flashing yellow arrow displays is dependent upon the signal phasing. Use the approved signal phasing diagram to determine which display types can be used for which movements. Typical vehicle signal displays are shown in Exhibit 1330-7 through Exhibit 1330-14. In addition to the display requirements contained in the MUTCD, the following also apply:

1. A minimum of two indications for the through movement, if one exists at an intersection, must be provided - even if it is not the primary (predominant) movement. Provide a minimum of two indications for the major signalized turn movement of an intersection if no through movement exists, such as on the stem of a T intersection. These signal faces are to be spaced a minimum of 8 feet apart. At a T intersection, select the higher-volume movement as the primary movement and provide displays accordingly.

A green left-turn arrow on a primary display and a green ball on the other primary display do not comply with this rule. At an intersection where left turns are prohibited, the leftmost through display may use a green up arrow in place of the green ball display. At an intersection where right turns are prohibited, the rightmost through display may use a green up arrow in place of the green ball display.

2. All displays for an approach, regardless of phase served, are to be a minimum of 8 feet apart.

3. Locate displays directly overhead and centered over the associated lane of the applicable vehicular traffic as it moves through the intersection. (See [Exhibit 1330-7](#) through [Exhibit 1330-14](#) for signal head locations.) For intersections with a skew for through traffic, locate signal displays for through traffic in one of the following ways:
 - a. Over the center of the outbound (far side) lane
 - b. Over a line drawn between the center of the approaching lane and the center of the associated outbound lane, ending at the stop lines

Left turn displays may either be located relative to the through displays or in line with approaching traffic, dependent on ability to mount the display(s). (See [Exhibit 1330-15](#) for skew placement examples.)

4. Locate displays a minimum of 50 feet and a maximum of 180 feet from the stop line. The preferred location of the signal heads is between 60 and 120 feet from the stop line. When the nearest signal face is located between 150 and 180 feet beyond the stop line, engineering judgment of conditions, including worst-case visibility conditions, is to be used to determine whether the provision of a supplemental or nearside signal face would be beneficial. When it is not physically possible to locate displays at least 50 feet from the stop line, the distance to the displays may be reduced as follows:
 - a. 3-section vertical and 5-section cluster (doghouse) displays may be located between 40 and 50 feet from the stop line.
 - b. 4-section vertical displays may be located between 41 and 50 feet from the stop line.
 - c. 5-section vertical displays may be located between 45 and 50 feet from the stop line.

The distances listed above are the minimums required to maintain 16.5 feet of clearance over the roadway with a backplate installed.

Overhead displays should always be located on the far side of the crossing roadway for the best visibility. Locating overhead displays on the near side of the roadway results in issues with visibility and driver compliance with stop lines. When an overhead display is located on the near side of the crossing roadway, the stop line typically has to be pushed back so that the minimum visibility distance is met. However, this also pushes the stop line back too far for drivers to see cross traffic, resulting in drivers creeping past the stop line towards the intersection – especially for turning traffic. This results in both the driver being stopped past the stop line and being unable to see the signal displays.

For ramp meter signals, place Type RM signal standards and displays at the stop line.

5. Use vertical vehicle-signal display configurations. Horizontal displays are not allowed unless clearance requirements cannot be achieved with vertical displays or unless they are being installed at an intersection to match other displays in the intersection. Approval by the State Transportation Operations Engineer is required for the installation of horizontal displays.
6. Use 12-inch signal sections for all vehicle displays except the lower display for a post mounted ramp meter signal.

7. Provide displays for turning movements with dedicated lanes as follows:
 - a. For protected movements, use all arrow displays.
 - b. For protected / permissive movements, use four section arrow displays. Alternatively, a shared five section cluster (doghouse) display may be used for both the turn lane and the adjacent through lane. Note: A three section arrow display, with bi-modal flashing yellow arrow / steady green arrow may be used in cases where windload or vertical roadway clearance will not allow for the use of a four-section display. If vertical clearance can be provided through adjustments to the signal display mount, such as mounting the Type M mount between different display sections, a four-section arrow display should be used.
 - c. For permissive right turns, a three-section arrow display with flashing yellow arrow ([Exhibit 1330-13](#)) is optional. This display is highly recommended where there are concerns regarding permissive right turns and the conflicting pedestrian crossing movement, such as known incidents or high volumes of both pedestrian crossings and right turn movements.
8. Use steady green arrow indications only when the associated movement is completely protected from conflict with other vehicular and pedestrian movements. This includes conflict with a permissive left-turn movement. At T intersections, steady green arrow displays may not be used for a movement that has a conflicting pedestrian movement.
9. Use either Type M or Type N mountings for vehicle display mountings on mast arms, as directed by the region maintenance staff or owning agency. Provide only one type of mounting for each signal system. Mixing mounting types at an intersection is not acceptable except for supplemental displays mounted on the signal standard shaft.
10. Use backplates for all overhead-mounted displays for new, updated, or rebuilt signal faces. Add backplates to all existing signal displays that do not already have them.
11. Use Type E mountings for pedestrian displays mounted on signal standard shafts unless otherwise approved by region maintenance staff or the owning agency.
12. Include supplemental signal displays when the approach is in a horizontal or vertical curve and the intersection visibility requirements of this section and the MUTCD cannot be met, unless approved otherwise by the Region Traffic Engineer.

Supplemental far side displays are recommended at intersections with higher truck volumes, as the trucks will frequently block visibility of overhead displays for following drivers. Supplemental far side protected left turn displays are recommended for long left turns.

Exhibit 1330-7 Signal Display Placements – Key to Diagrams

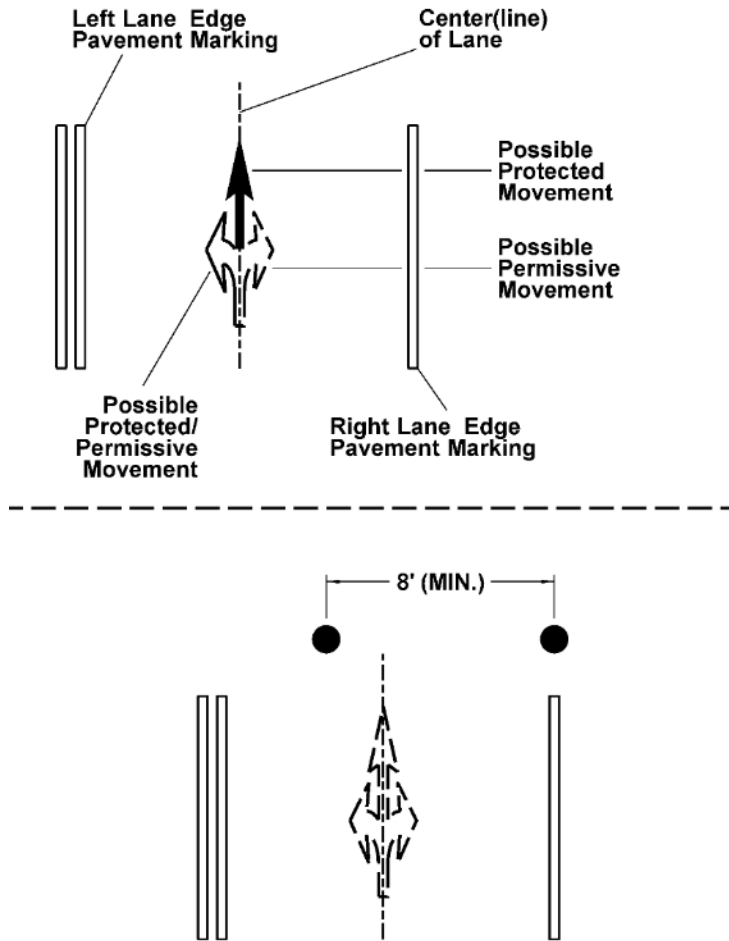

Pavement markings are used to represent possible lane lines and vehicular movements. The lane lines shown are typical, but not necessarily required.

All signal mounts must be a minimum of 8 feet apart, measured center to center. This example shows typical mount locations for a single approach lane.

Exhibit 1330-8 Signal Displays for Single Lane Approach

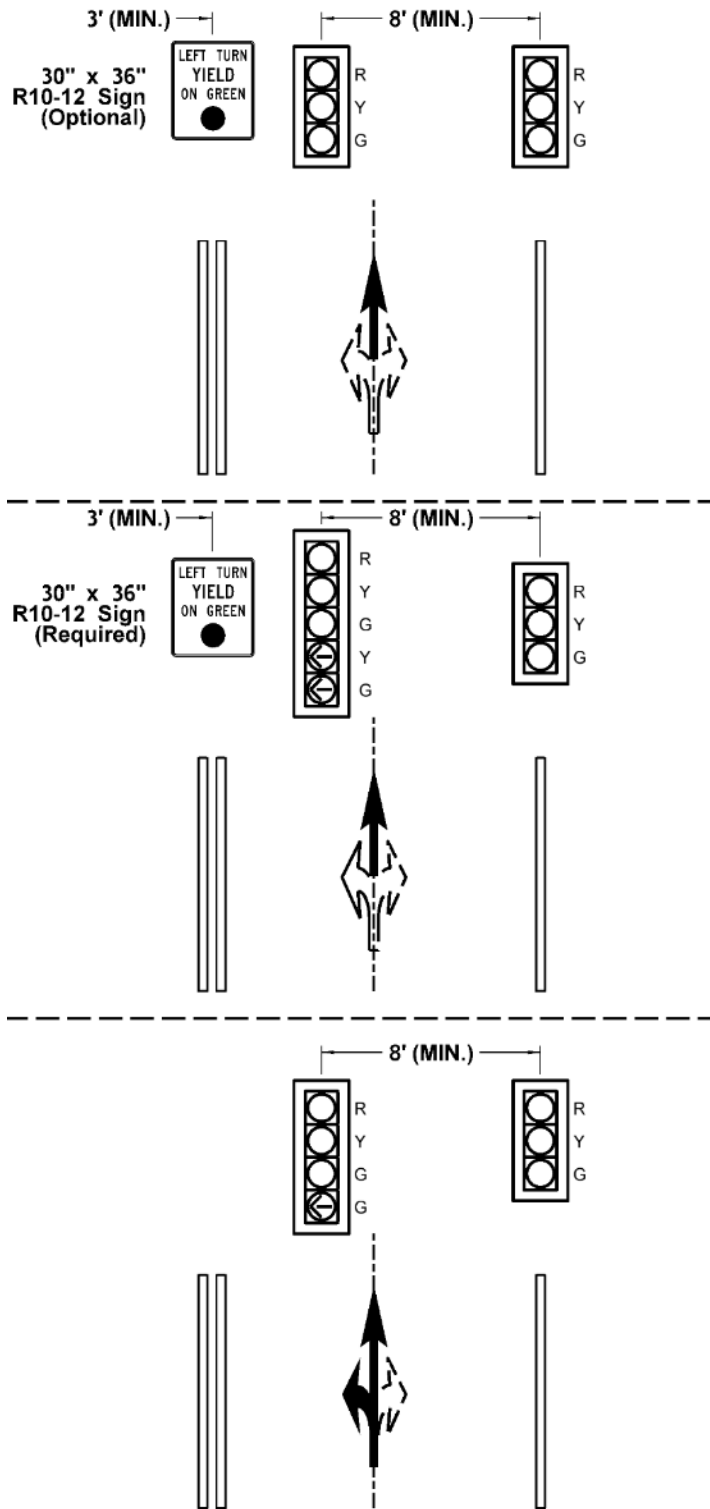

Single lane approach with permissive (or no left turns). R10-12 sign optional. Where left turns are prohibited, install a 30" x 30" R3-2 No Left Turn (Symbol) Sign in place of the R10-12 sign shown here.

Single lane approach with protected / permissive left turns. R10-12 sign required.

Single lane approach with protected left turns.

Exhibit 1330-9 Signal Display Mounting Locations for Multi-Lane Approaches

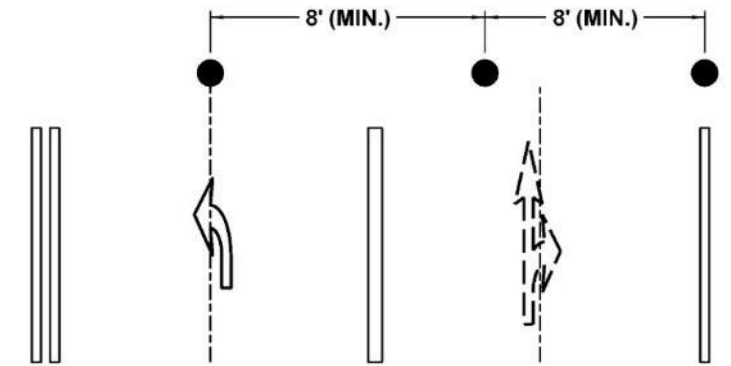

Single through lane with left turn lane(s).
Through lane displays arranged the same as for a single lane approach.
Left turn display(s) centered over lane(s).

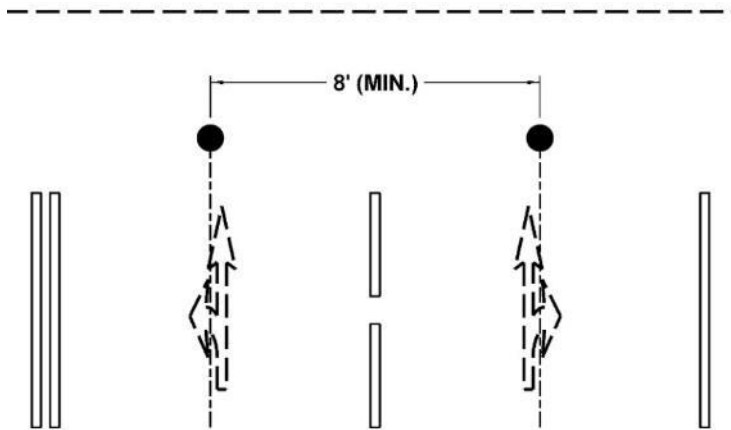

Multiple through lanes.
Center displays over each lane.

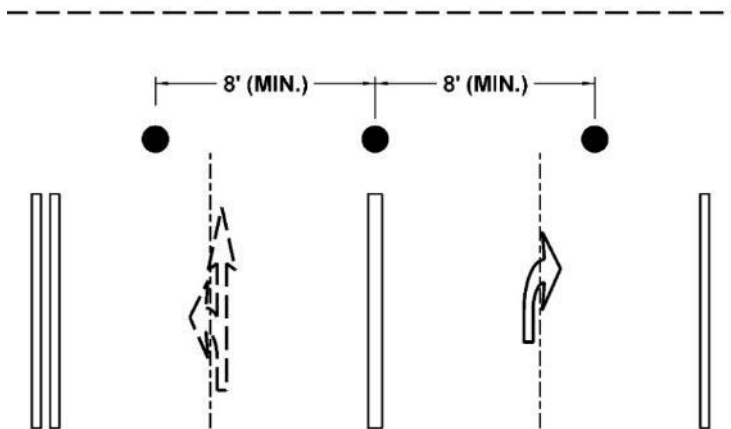

Single through lane with right turn lane(s).
Through lane displays arranged the same as for a single lane approach.
Ensure that the 8-foot spacing requirement is met if a right turn display is installed overhead.

Exhibit 1330-10 Signal Displays for Dedicated Left Turn Lanes

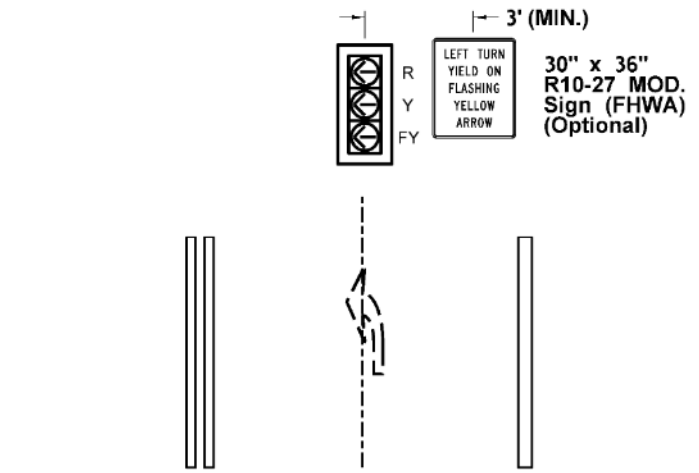

Dedicated left turn lane with permissive left turns.
R10-27 (Modified) sign optional.

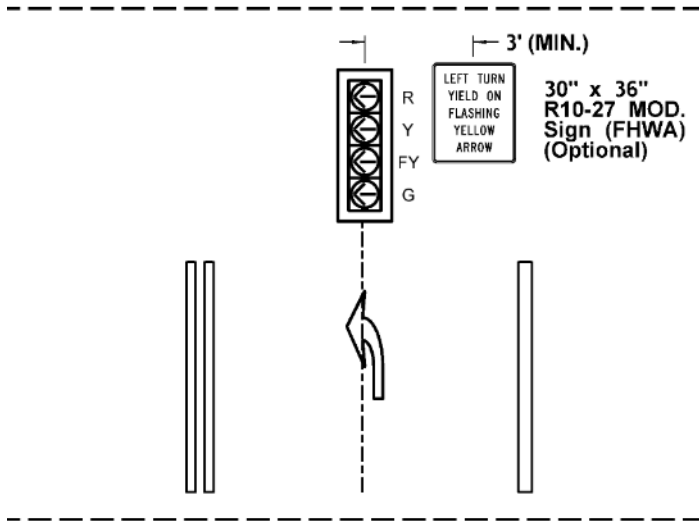

Dedicated left turn lane with protected / permissive left turns.
R10-27 (Modified) sign optional.

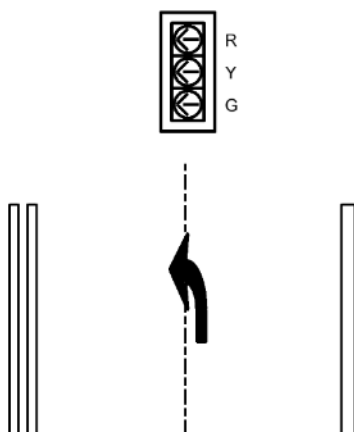

Dedicated left turn lane with protected left turns.

Exhibit 1330-11 Signal Displays for Shared Through-Left Lanes – Multiple Through Lanes

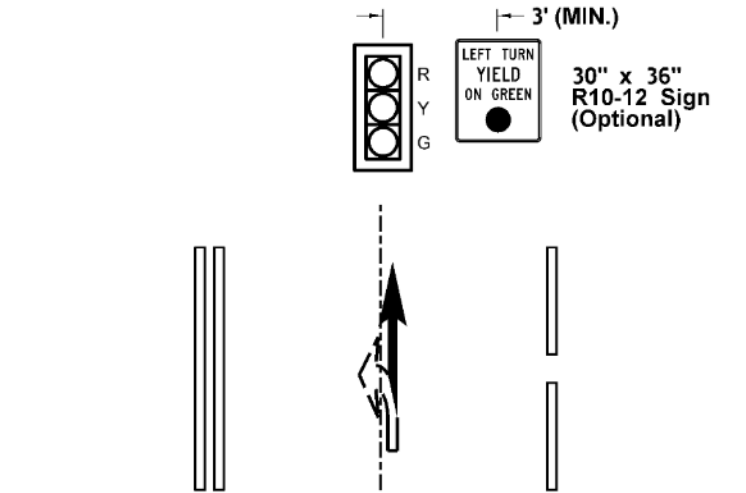

Shared through-left lane with permissive left turns.
R10-12 sign optional.

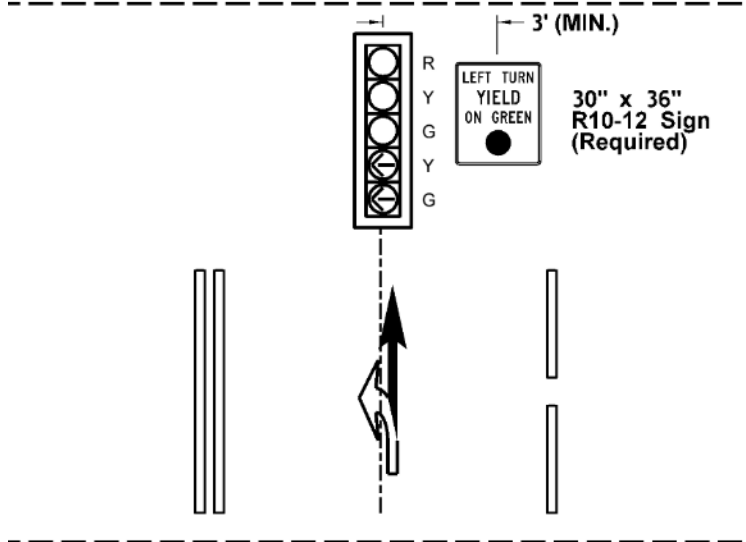

Shared through-left lane with protected / permissive left turns.
R10-12 sign required.

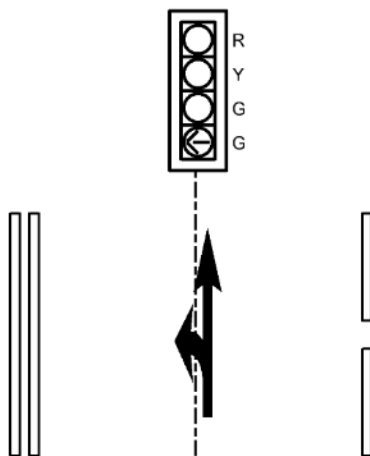

Shared through-left lane with protected left turns.

Exhibit 1330-12 Signal Displays for Shared Through-Right Lanes

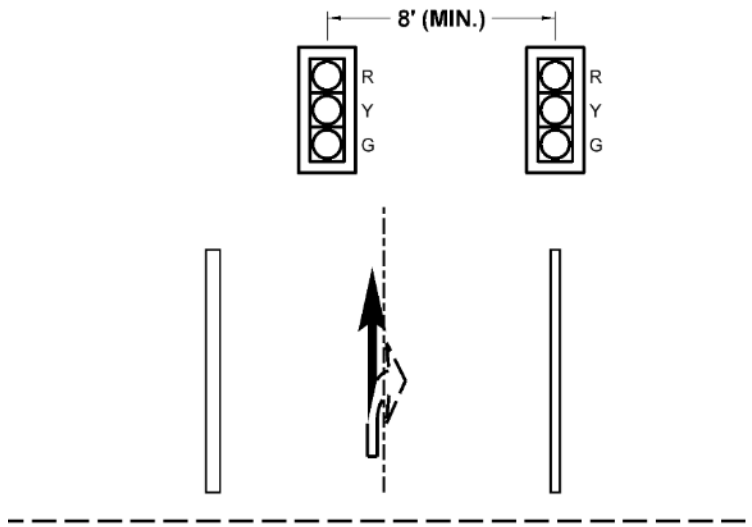

Single shared through-right lane with permissive right turns.

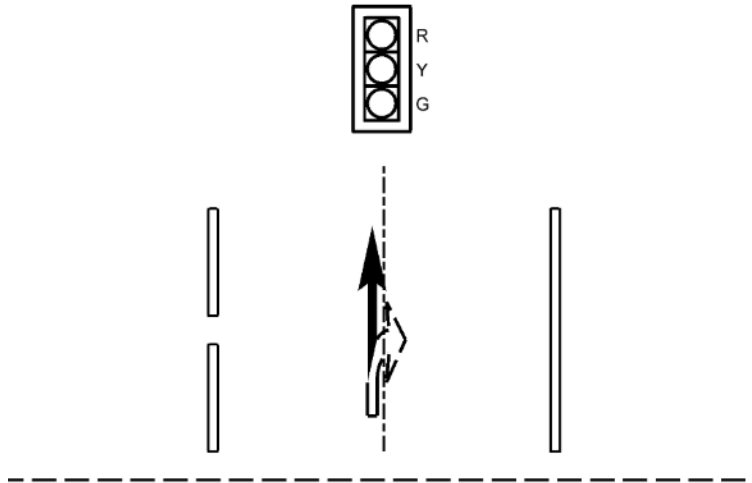

Shared through-right lane, multiple through lanes, with permissive right turns.

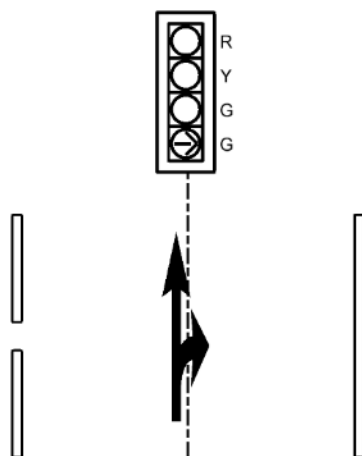

Shared through-right lane, multiple through lanes, with protected right turns. For protected / permissive right turns, mirror protected / permissive left turn display from [Exhibit 1330-11](#).

Exhibit 1330-13 Signal Displays for Dedicated Right Turn Lanes

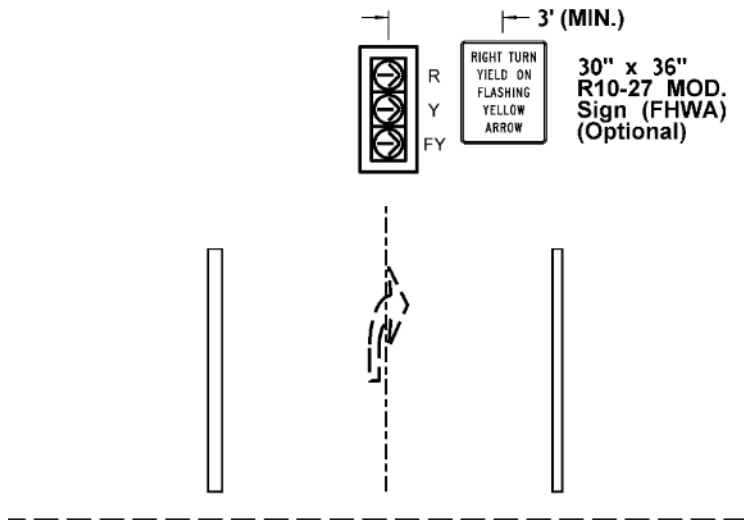

Dedicated right turn lane with permissive right turns.
R10-27 (Modified) sign optional.

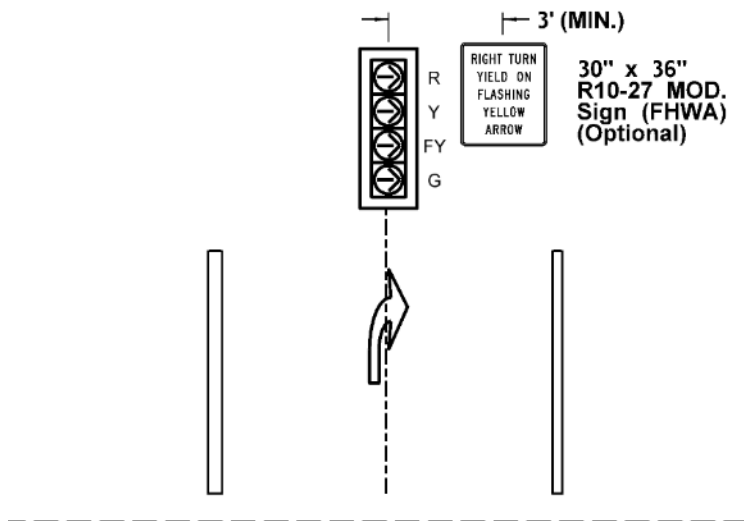

Dedicated right turn lane with protected / permissive right turns.
R10-27 (Modified) sign optional.

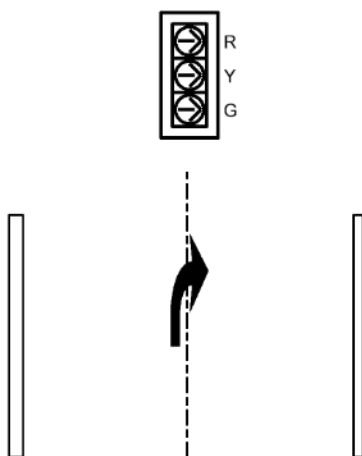

Dedicated right turn lane with protected right turns.

Exhibit 1330-14 Signal Displays for Multiple Turn Lanes

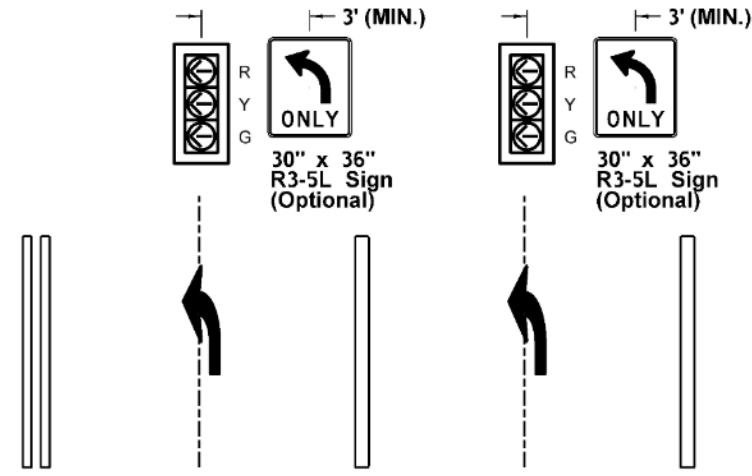

Multiple left turn lanes.
R3-5L signs optional.

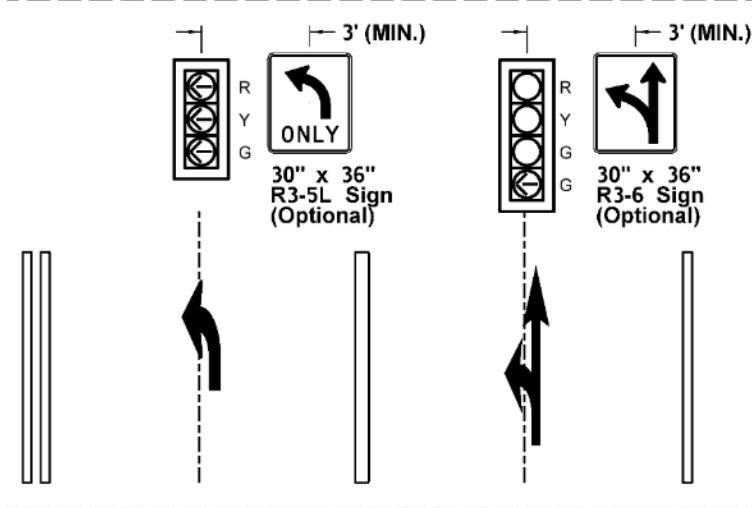

Multiple left turn lanes, with a
shared through-left lane.
R3-5L and R3-6 signs optional.
Mirror for right turns.

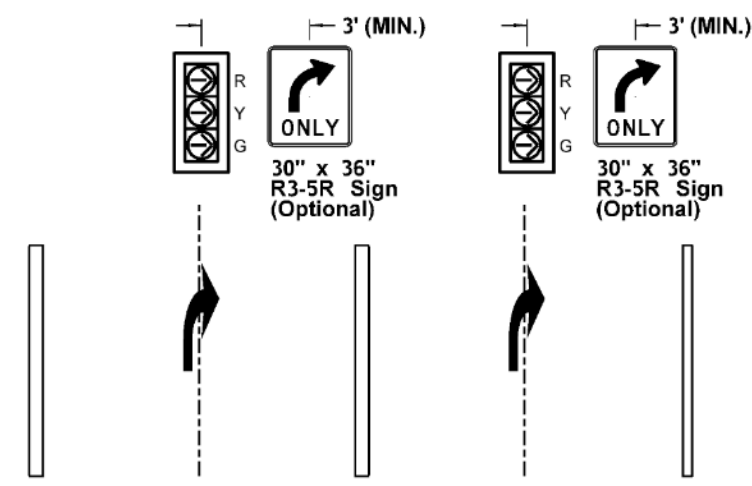

Multiple right turn lanes.
R3-5R signs optional.

Exhibit 1330-15 Example Signal Display Placement for Skew Intersection

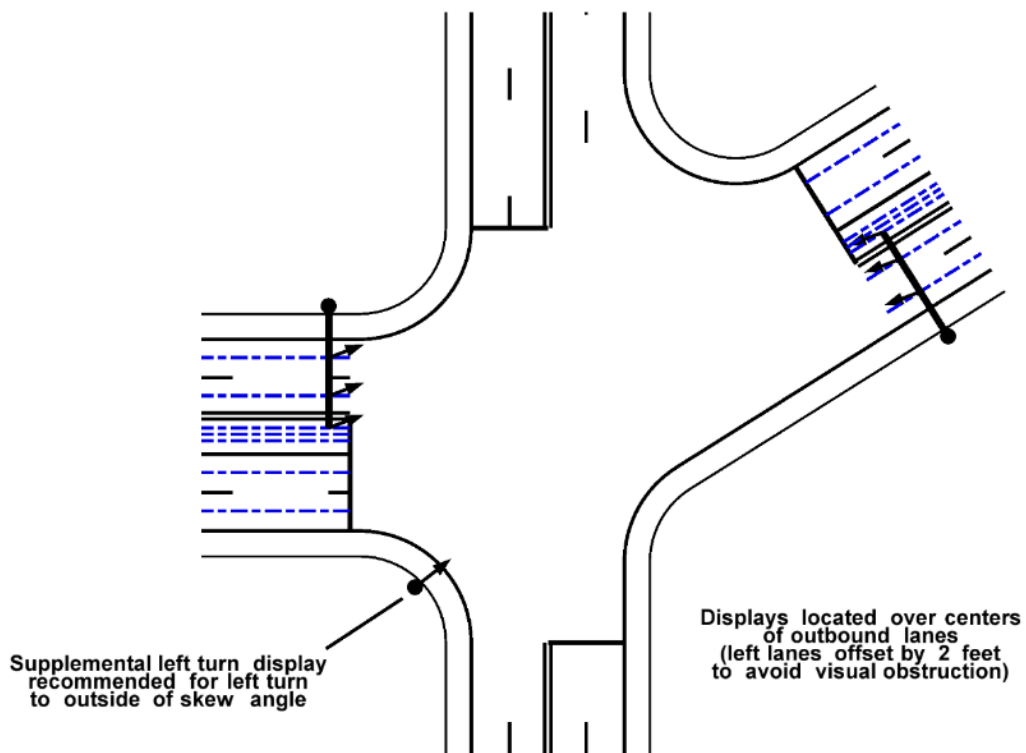
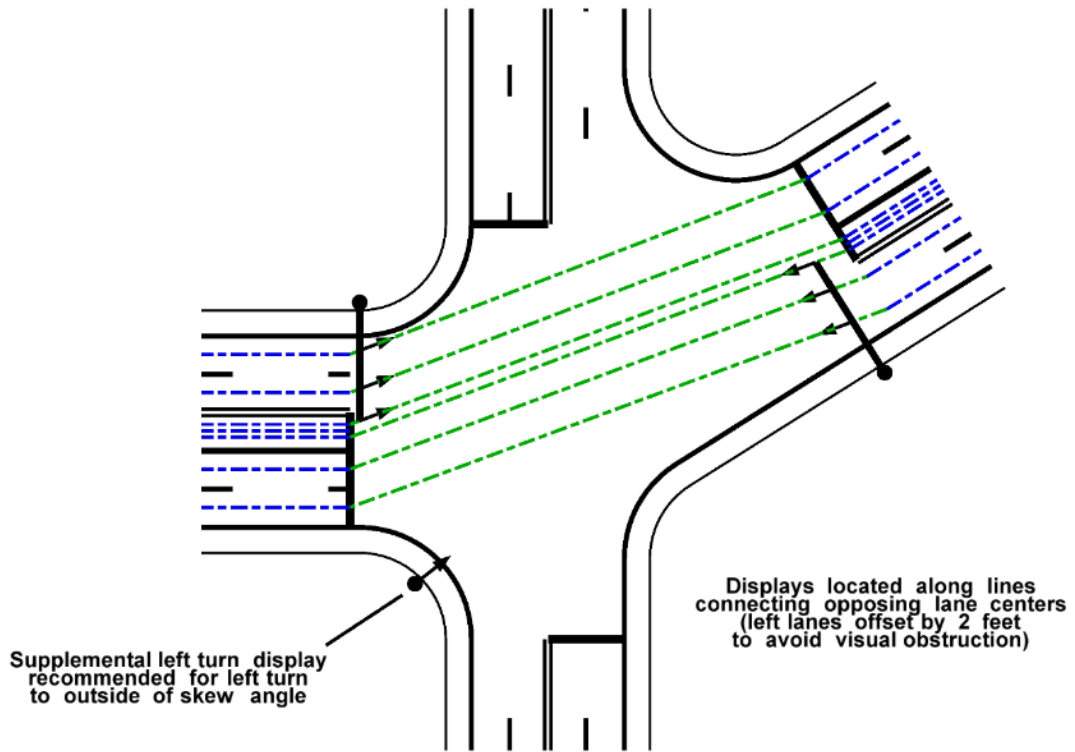

The minimum mounting height for overhead signal displays is 16.5 feet from the roadway surface to the bottom of the signal housing, including the backplate. There is also a maximum height for signal displays allowed by the MUTCD, since the roof of a vehicle can obstruct a motorist's view of a signal display. The maximum heights from the roadway surface to the bottom of the signal display housing with 12-inch displays are shown in [Exhibit 1330-9](#).

Exhibit 1330-16 Signal Display Maximum Heights

Distance to Stop Line (ft)	Signal Display Arrangement	Maximum Height (to bottom of display housing [3])
40 [1]	Vertical 3-section	17.5 ft
42 [1]	Vertical 4-section	17.0 ft
45 [1]	Vertical 5-section [2]	17.0 ft
53 to 180	Vertical 3-section	22.0 ft
	Vertical 4-section	20.8 ft
	Vertical 5-section [2]	19.6 ft

Notes:

- [1] Minimum distance required to achieve 16.5 feet of clearance with backplate installed.
- [2] For 5-section cluster displays, use the Vertical 3-section heights.
- [3] Subtract 0.5 ft for height to bottom of backplate.

At signalized intersections with railroad preemption, install blankout signs for turning movements that do not have a dedicated signal display (3-section arrow display). Blankout signs are 36" x 36" and will display either a No Right Turn symbol (R3-1) or No Left Turn symbol (R3-2) when activated, as appropriate. Blankout signs should be placed the same as equivalent static signs.

1330.04(4) Pedestrian Equipment

Pedestrian equipment consists of pedestrian signal displays and pedestrian detectors (pushbuttons). New signal systems are required to use countdown displays and Accessible Pedestrian Signal (APS) pushbuttons. See Section [1330.04\(4\)\(a\)](#) for pedestrian display and detection requirements for existing signal systems. No intersection may have a mix of APS and non-APS pushbuttons, nor may any intersection have a mix of countdown and non-countdown pedestrian displays.

Pedestrian displays are required to be installed with the bottom of the display housing no less than 7 feet or more than 10 feet above the sidewalk surface. Pedestrian displays are required to be installed to provide maximum visibility at the beginning of the controlled crosswalks. To accomplish this, pedestrian displays should be located no more than 5 feet from the outside edge of the crosswalk, as measured on a line perpendicular to the crosswalk centerline (See [Exhibit 1330-17](#)). This distance may be increased up to a maximum of 10 feet from the outside edge of the crosswalk if physical constraints prevent the display from being placed no more than 5 feet from the outside edge of the crosswalk.

Exhibit 1330-17 Pedestrian Display Placement Requirements

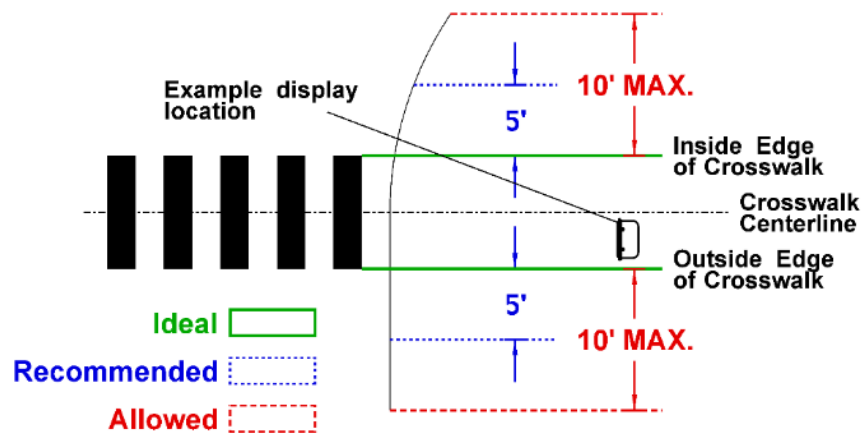

Pedestrian pushbuttons (PPBs) are required to be located within a certain distance of the crosswalk being served and oriented such that the sign on the pushbutton is parallel to the crosswalk served. Pedestrian pushbutton location requirements are as follows:

- The PPB setback distance is measured from one of the following:
 - The face of curb, where sidewalk or curb is present.
 - The edge line of the roadway, where there is no sidewalk or curb present.
 - Or the edge of pavement, where there is no edge line, sidewalk, or curb present.
- The preferred PPB setback distance is 6 feet but may be increased up to a maximum 10 feet. Contact the HQ Transportation Operations Division if the PPB setback distance cannot be kept to 10 feet or less.
- The minimum PPB setback distance is 4 feet. If a planter strip or similar buffer strip is present, with justification, the minimum PPB setback may be reduced to 1.5 feet from the curb face or edge line. The PPB setback distance shall not be less than 1.5 feet.
- The PPB should be located as close to the outside edge of the crosswalk line as possible, so that for APS PPBs, the button and sign face towards the core of the intersection, rather than back down the adjacent approaching roadway. The PPB may be located no more than 5 feet outside either edge of the crosswalk line.
- If possible, PPBs should be located on separate poles and be separated by a minimum of 10 feet.
- See [Exhibit 1330-18](#) for recommended and allowed PPB placement locations.

Exhibit 1330-18 PPB Placement Requirements

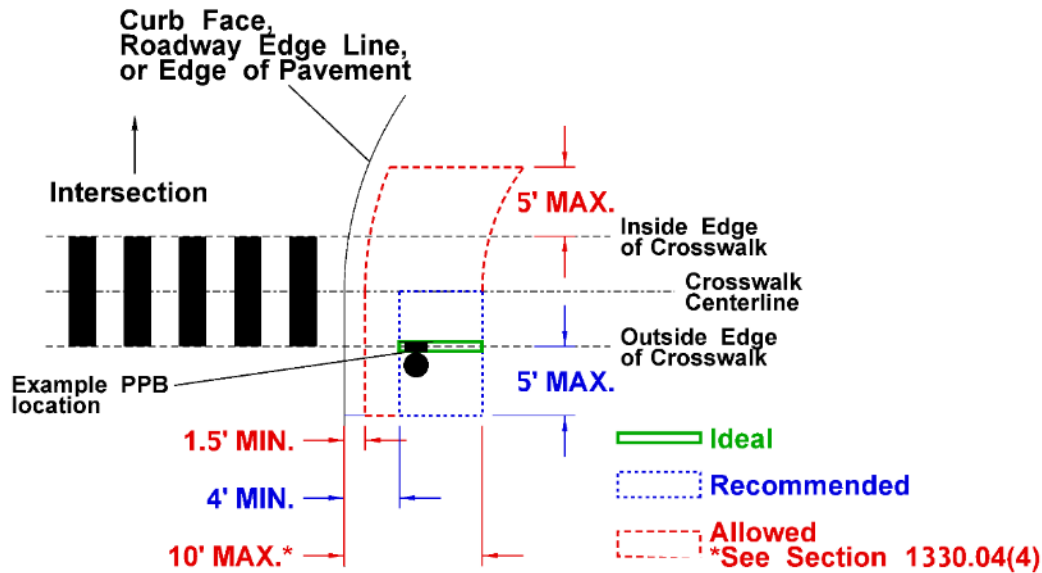

PPBs are required to be located so that the actual button, not just the assembly, is within 9 inches horizontally of a level all-weather surface (generally sidewalk or paved road shoulder) as described in [Chapter 1510](#). To accomplish this, certain criteria must be met depending on the type of pole upon which the pushbutton is installed:

- For vertical shaft poles (Type PPB, PS, I, FB, or RM), the center of the pole shall be no more than 9 inches from the edge of the level clear space. The pushbutton shall not be oriented more than 90 degrees from facing the level clear space. (See [Exhibit 1330-19](#).)
- For larger signal standards (Type II, III, IV, IV, or SD), the button must face the level clear space, with the edge of the pole baseplate no more than 6 inches from the edge of the level clear space. It is recommended that the pole either be in the sidewalk, or the edge of the pole base plate be installed as close to the back of sidewalk as possible. (See [Exhibit 1330-20](#).) Some minor rotation of the button on the pole is possible, but even smaller angles may quickly exceed the allowed reach limit – particularly on larger poles.

60-inch by 36-inch clear space shown in [Exhibit 1330-19](#) and [Exhibit 1330-20](#) for reference only – see Section [1510.12\(1\)\(b\)](#) for clear space requirements.

Exhibit 1330-19 PPB Placement on Vertical Shaft Poles

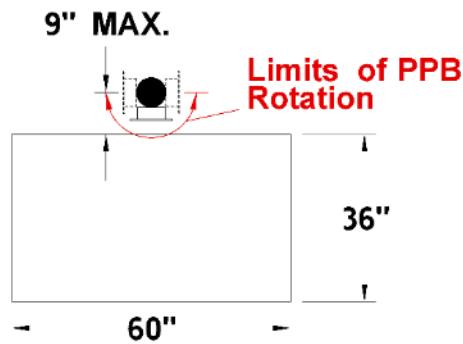
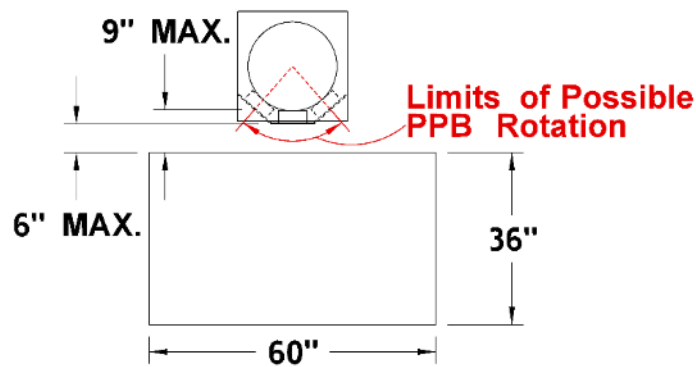

Exhibit 1330-20 PPB Placement on Large Signal Standards



60-inch by 36-inch clear space shown in [Exhibit 1330-19](#) and [Exhibit 1330-20](#) for reference only – see Section [1510.12\(1\)\(b\)](#) for clear space requirements.

In all cases, it is recommended that the pole be installed in the sidewalk for maximum accessibility. However, the pole and the pushbutton itself are obstructions and must not encroach upon the required minimum pedestrian access route widths (see [Chapter 1510](#)).

PPBs are required to be installed at 42 inches above the level clear space, as measured to the center of the actual button. Existing pushbuttons do not require a height adjustment if the center of the actual button is within a range of 36 to 48 inches above the level clear space.

Where there is a median or center island with a pedestrian refuge, consult with signal operations to determine if a pushbutton should be installed in the pedestrian refuge area. This may be justified for locations with particularly long crossings or slower moving pedestrians.

For WSDOT owned systems, pedestrian signal equipment may not be installed on light standards. Do not install pedestrian signal equipment on light standards for systems owned by other jurisdictions unless directed to do so by that jurisdiction.

1330.04(4)(a) Accessible Pedestrian Signals and Countdown Pedestrian Displays

Accessible Pedestrian Signals consist of a pedestrian pushbutton with integrated vibro-tactile and audible versions of the visual indications presented by pedestrian signal displays. APS are required at any location with a pedestrian display – *even if there was no pedestrian detection previously*.

This is due to the requirement to provide non-visual indication of the pedestrian phase. All new construction traffic signals are required to include APS.

Countdown pedestrian displays are displays which use a combination of an overlapping person (walk) and hand (don't walk) indication and an adjacent two-digit countdown timer display. The timer counts down the seconds remaining in the pedestrian clearance phase (flashing don't walk). For WSDOT owned traffic signals, all new construction traffic signals are required to include countdown pedestrian displays. For new construction traffic signals owned by other jurisdictions, countdown pedestrian displays are required unless directed otherwise by the owning jurisdiction.

For existing signalized intersections where pedestrian equipment was not previously installed, the installation of APS and countdown pedestrian displays is required for the entire intersection. This may require new or relocated poles, as well as additional ramp and sidewalk work beyond that necessary for basic sidewalk and ramp ADA compliance.

At signalized intersections with existing pedestrian equipment, APS and countdown pedestrian signal displays are required to be installed unless one of the following are true:

1. Where pushbuttons are only being adjusted in height or orientation.
2. Where pushbuttons are being relocated on a single corner, including to a new pole, and no other work (including sidewalk or ramp work) is taking place at any other corner, pushbuttons may be relocated or replaced with the same type of pushbutton as currently exists at that intersection. New pole location(s) must meet accessibility requirements for pedestrian pushbuttons (see Section 1510.12). Accessibility for any affected poles must be evaluated for both existing pushbuttons and future APS pushbuttons.

These two cases are considered minor signal upgrades, and do not require the installation of APS pushbuttons or countdown pedestrian displays at that intersection.

At any signalized intersection where APS pushbuttons are being installed in response to a public request, replace all pushbuttons and pedestrian displays with APS pushbuttons and countdown pedestrian displays at that intersection. Additional poles may be required, and ramp and sidewalk work may be necessary to support access to new APS locations / orientations.

Replacement of existing pushbuttons with new APS pushbuttons, where no other work is performed, is considered a maintenance activity and may be done without other ADA improvements provided that the new APS pushbuttons are located where there is equal or better access than the existing pushbutton installation, including the distance from edge of sidewalk, distance from edge of curb, clear space available, and clear space slope. If the new APS pushbutton location does not provide equal or better access to the pushbutton than the existing pushbutton location, then additional sidewalk and/or ramp work is required.

APS pushbuttons are required to include the following features:

1. Audible and vibrotactile indications of the WALK interval.
2. A locator tone which operates only during the DON'T WALK and flashing DON'T WALK intervals.
3. A tactile arrow on the pushbutton (control surface) indicating the crossing direction served. This arrow must be high contrast with the rest of the button – either light on dark or dark on light.
4. An integral 9" x 15" R10-3e sign.
5. If additional crossing time will be provided as part of an extended press feature, a supplemental R10-32P sign is required to be installed adjacent to or integral with the APS PPB.

1330.05 Pedestrian Hybrid Beacons and Flashing Beacon Systems (New 2024)

Pedestrian Hybrid Beacon (PHB) and Pedestrian Flashing Beacon (PFB) systems are simplified versions of conventional pedestrian traffic signals. Each one requires specific justification for their use.

1330.05(1) Pedestrian Hybrid Beacons (New 2024)

Pedestrian Hybrid Beacon (PHB) systems, sometimes referred to as “HAWK” (High-intensity Activated crossWalk) systems, are effectively identical to a conventional pedestrian traffic signal with the following exceptions:

- They use a specialized arrangement of signal displays.
- There is no vehicle detection.
- The phase sequence is different.

PHBs may be used when justified as defined in the MUTCD. For PHBs that will be owned and operated by WSDOT, conventional traffic signal systems shall be used in place of a PHB if either of the following are true:

- The PHB is within one-half mile of another conventional traffic signal system.
- The PHB is within an existing signalized corridor.

For these conditions, a conventional traffic signal system is justified under Signal Warrant 6, Coordinated Signal System, and shall be documented as “PHB justified in signalized corridor”. PHBs may not be installed at an intersection on a state highway unless the side streets are restricted to right-in/right-out only.

Equipment types and placement shall be the same as required for a conventional traffic signal system as described in Section 1330.04. PHB vehicle signal displays have an area of 10.3 square feet for the purposes of signal mast arm wind load calculations. PHB systems that will be owned and operated by WSDOT shall be designed such that they can be converted to a conventional red/yellow/green vehicle display by only changing the vehicle displays themselves - no other equipment or wiring changes shall be needed for this conversion.

PHB systems require the inclusion of either a street name sign or an overhead “crosswalk” sign in place of a street name sign. An R10-23 (Crosswalk – Stop on Red) sign is also required on the mast arm between every adjacent overhead signal display, or to the left of the signal display when there is only one overhead display. WSDOT owned and operated PHB systems shall not include retro-reflective tape on the signal display back plates, but local agencies may include them provided that the street name or crosswalk sign is present on the mast arm.

Exhibit 1330-21 PHB Signal Equipment (New 2024)**1330.05(2) Pedestrian Flashing Beacons (New 2024)**

Pedestrian flashing beacon (PFB) systems consist of any pedestrian activated flashing yellow beacon system. These include both simple circular yellow flashing beacon systems and rectangular rapid flashing beacon (RRFB) systems. WSDOT is currently only using RRFB systems for PFBs, but other agencies can consider circular yellow flasher systems at their discretion.

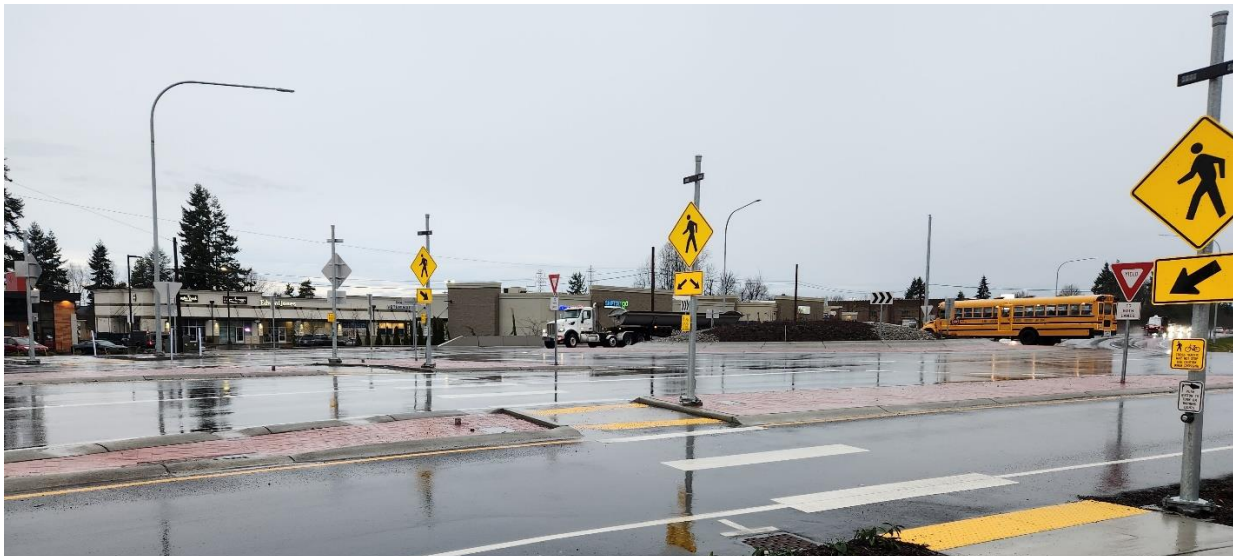
Exhibit 1330-22 RRFB System (New 2024)

Chapter 4 of the WSDOT Traffic Manual shall be used to determine whether an RRFB system is appropriate for any location where such a system is being considered. RRFBs are required on a state highway for any location where they are listed as “required” in the WSDOT Traffic Manual – circular beacons may not be used in place of RRFBs.

RRFB systems consist of a Type FB signal standard with applicable warning signs, an RRFB light bar installed above the signs, and a pedestrian pushbutton. WSDOT installs the RRFB above the sign to move it out of a driver’s line of sight when they are looking for a pedestrian that activated the system.

Pedestrian pushbuttons for any type of PFB (RRFB or circular) are required to be accessible. These pushbuttons are referred to as Accessible Information Device (AID) pushbuttons, and are similar to an Accessible Pedestrian Signal (APS) pushbutton with the following differences:

- There is no vibration function. Vibro-tactile indications are restricted to representing a pedestrian walk signal indication only and shall not be used for flashing beacon systems.
- They use only a speech message for audible indication, which relates to the status of the flashing beacons.
- AID pushbuttons and APS pushbuttons use different integral signs.

AID pushbuttons follow the same general placement requirements as APS pushbuttons as described in Section [1330.04\(4\)](#). However, where RRFB poles and pushbuttons are located next to a ramp and/or its associated landing rather than behind it, they shall be located downstream of the ramp as viewed by a driver in the approaching lane [Exhibit 1330-23](#) shows how the position of the Type FB pole can obstruct a driver’s line of sight. For median splitter islands that are not constant width (such as roundabout median splitter islands), the FB pole shall be located on the wider portion of the island. For median islands that are constant width, the designer shall evaluate which direction will have greater difficulty seeing a pedestrian if the pole is in a driver’s line of site. [Exhibit 1330-24](#) shows typical pole placements for these cases. Where the median cut through is offset rather than straight through, coordinate placement with the HQ Traffic Office as in most cases two separate median poles will be necessary.

Exhibit 1330-23 FB System Pole Placement (New 2024)

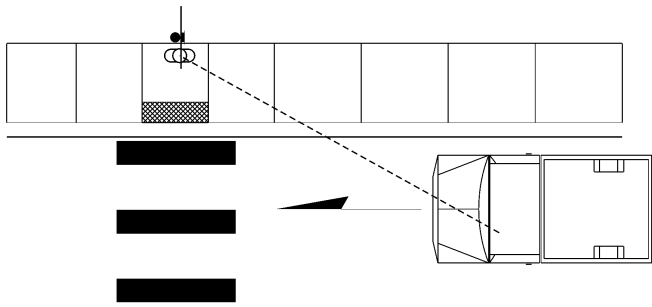

Acceptable - Sign and post are not between pedestrian and driver.

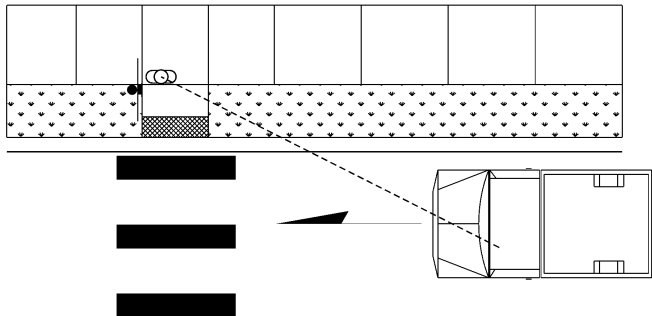

Acceptable - Sign and post are not between pedestrian and driver.

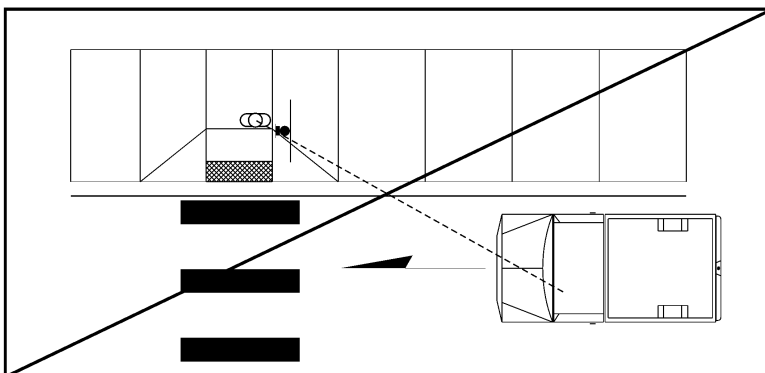

Not Acceptable - Pedestrian to Driver sight line obstructed by sign and post.

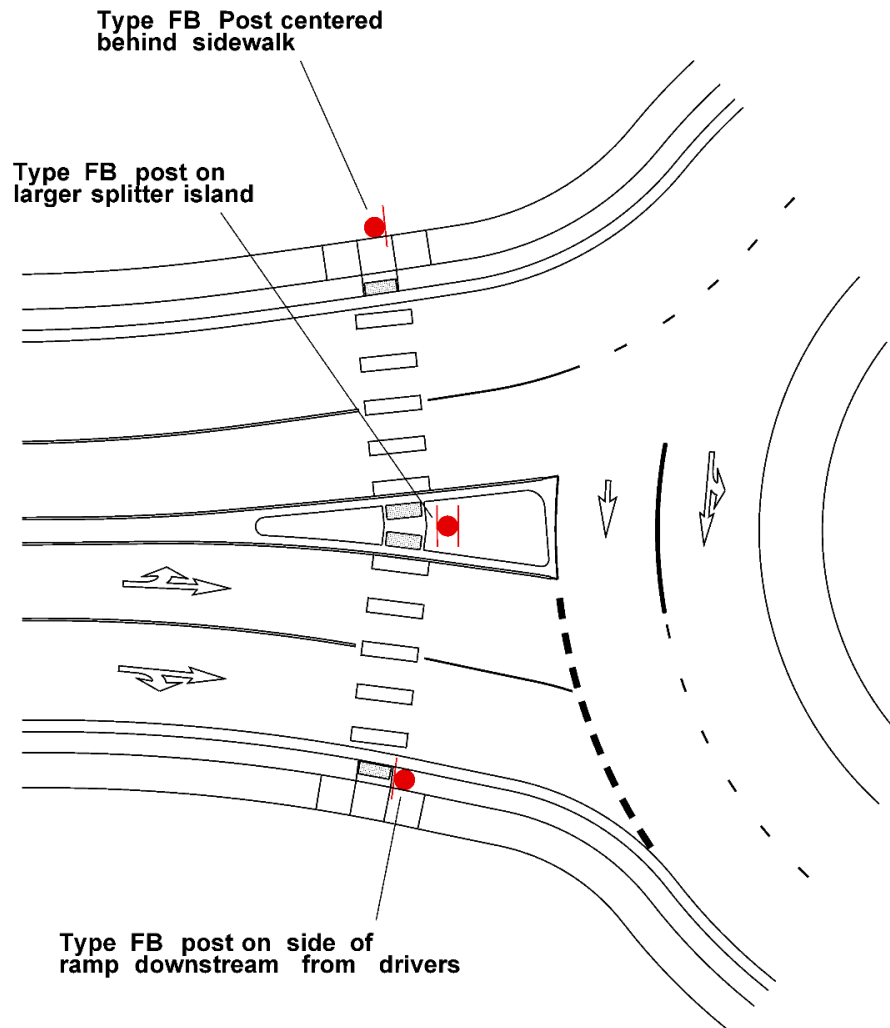
Exhibit 1330-24 Typical Roundabout FB Pole Placement (New 2024)**1330.05(3) Signal Standards (Supports)**

Signal standards consist of five main types of supports: Vertical Steel Shaft, Cantilevered Steel Mast Arm, Steel Strain Pole, Wood Strain Pole, and Signal Bridge. The type of support selected will depend on required placement of vehicle signal displays and the ability of the support to reach that location. The MUTCD states that the preferred location for signal displays is overhead on the far side of the intersection.

Signal displays may also be mounted to bridges where clearance will not allow an alternate signal standard type. Installation on bridges requires approval of both the Region Traffic Engineer and the HQ Bridge and Structures Office.

Signal Standards shall be considered in the following order of preference:

1. **Cantilevered Steel Mast Arm.** These are the standard support type for permanent systems and should be used whenever possible. Mast arm installations are preferred because they generally provide better placement of the signal displays, greater stability for signal displays in high-wind areas, and reduced maintenance costs. Mast arm lengths are limited to 65 feet from center of pole to farthest display mount – if additional length is needed, an alternate support type must be used.

2. **Span Wire System (Steel or Wood Strain Poles).** These systems may be used when displays are needed at a greater distance than a mast arm system can support, or if a system is expected to be in place for less than 5 years. Steel poles are required to be used for permanent signal systems. Temporary signal systems (systems to be removed under the same contract as installation) may use wood poles. The use of wood poles beyond the end of a contract or for longer than 5 years requires the approval of the Region Traffic Engineer. Individual spans have a limit of 150 feet – longer spans require design by the HQ Bridge and Structures Office.
3. **Signal Bridge.** Signal bridges shall only be used when no other alternative can physically be installed, and support displays in the required locations. Diagonal signal bridges may not be used for WSDOT signal systems – only signal bridges across a single approach may be used. Diagonal signal bridges are extremely difficult to maintain and result in displays being too close to at least one of the two cross streets, resulting in poor display visibility, and any structural failure will result in the loss of the entire signal system, rather than just one or two directions. Single Point Urban Interchanges (SPUIs) where a signal bridge is required across the center of the intersection are not considered a diagonal span and may be used.
4. **Vertical Steel Shaft.** Vertical steel shaft supports should only be used for supplemental vehicle displays or pedestrian equipment. In special cases (such as in a small historic town), vertical steel shaft supports may be used without overhead signal displays if approved by the Region Traffic Engineer, as allowed by the MUTCD. Justification shall be provided for the use of vertical steel shaft signals without any overhead signal displays, as displays are too easily obstructed from view.

When placing signal standards, the primary consideration is the visibility of signal faces. Place the signal supports as far as feasible from the edge of the traveled way without adversely affecting signal visibility. (The [MUTCD](#) provides additional guidance on locating signal supports.) Initially, lay out the location for supports for vehicle display systems, pedestrian detection systems, and pedestrian display systems independently to determine the optimal location for each type of support. Consider the need for future right-turn lanes or intersection widening when choosing the final location of the signal standards. Poles should also be located outside of sight triangles for turning traffic. See Section [1600.03\(2\)\(e\)](#) for more information and documentation requirements.

If conditions allow and optimal locations are not compromised, pedestrian displays and pedestrian detectors can be installed on the vehicular display supports. However, pole placement cannot encroach on pedestrian access route or maneuvering space requirements. Pole mounted appurtenances, such as pushbuttons, terminal cabinets, and displays, need to be taken into consideration regarding their encroachment into accessible spaces.

Another important consideration that can influence the position of signal standards is the presence of overhead and underground utilities. Verify the location of these lines during the preliminary design stage to avoid costly changes during construction:

- a. **Underground Utilities:** Underground utilities must be located, marked, and surveyed. If any underground utility is within 10 feet of any foundation, consider potholing for the utility to find its actual location. Field locates are rarely precise and must be verified if a potential conflict exists.
- b. **Overhead Utilities:** Signal standards may be located within close proximity to overhead communications lines (phone, cable, fiber-optic), but the lines should not touch the any part of the signal system and should not pass in front of any displays. Overhead power lines require a minimum 10-foot circumferential clearance for lines rated at 50kV (50,000 V) or below, including the neutral. For lines rated over 50kV, the minimum clearance is 10 feet plus 0.4 inches for each kV over 50kV. Overhead utilities may have to be relocated if a suitable location for signal equipment cannot be found.

Once pole locations have been selected, a soils investigation is required to determine the lateral bearing pressure, the friction angle of the soil, and whether groundwater may be encountered. Standard foundations may be used if the soil lateral bearing pressure is at least 1,000 psf, the friction angle is at least 17°, and the ground slope is 2H:1V or flatter. Standard foundation information is found in the [Standard Plans](#), and depends on the type of support system being used.

Special foundation designs are required if the soil lateral bearing pressure is less than 1,000 psf, the friction angle is less than 17°, or the ground slope is steeper than 2H:1V. The region materials group works with the HQ Materials Laboratory to determine the bearing pressure and friction angle of the soil at the proposed foundation locations. If soils do not meet these minimum values for lateral bearing pressure and friction angle, the signal standard charts and soil conditions report (summary of geotechnical conditions for foundations) must be forwarded to the HQ Bridge and Structures Office with a request for special foundation design. The HQ Bridge and Structures Office designs foundations for the regions and reviews designs submitted by others.

Where poles are installed on structures, the anchorage must be designed by the Bridge designer. Coordinate with the Bridge designer for placement and design of pole anchorages on structures.

Do not place any signal standard in a median area. The sole exception is a Type PS or Type PPB signal standard as required for median refuge areas for pedestrians.

Coordinate with all stakeholders (Maintenance, Signal Operations, Civil Design Engineer, Drainage Engineer, and so on) in the placement of signal equipment to avoid any possible conflicts. Arrange field reviews with the appropriate stakeholders as necessary.

1330.05(3)(a) Mast Arm Signal Standards and Foundation Design

Mast arm signal standards are designated by the following types:

- Type II: Single mast arm with no luminaire mount.
- Type III: Single mast arm with luminaire mount.
- Type SD: Double mast arm, with or without luminaire mount.

Mast arm signal standards are normally located on the far-right corner of the intersection from approaching traffic. A typical mast arm signal standard only has one mast arm, however two may be used. If the angle between the two arms is not exactly 90 degrees, the design must be sent to the bridge and structures office. In most cases, two arms at 90 degrees can support the necessary display positioning.

Additionally, signal standards on mast arms may be rotated up to 30 degrees from center. Do not allow a mast arm for one direction to cross in front of the mast arm for a different direction if possible, as it results in a visual obstruction of the signal displays. Where two double arm signal standards are installed on opposite corners, the preferred location for the two poles are the far-right corners of the mainline roadway. This way, the mast arms for the mainline traffic will not cross in front of each other.

Mast arm signal standards have a typical arm attachment point of 18 to 20 feet in height. This height range needs to be taken into consideration when placing signal displays in order to ensure that the display height requirements shown in Section [1330.04\(3\)](#) are met. The attachment point height may be adjusted throughout this range as necessary but increments of 0.5 feet are recommended for ease of fabrication. Connection points outside of this range are a special design and require design support from the Bridge and Structures Office.

Mast arm signal standards are designed based on the total wind load moment on the mast arm. The moment is a function of the surface area of each appurtenance (signal display or sign), $X * Y$, and the distance between the vertical centerline of each appurtenance and the vertical centerline of the signal pole Z .

This determines the total wind load moment, referred to as an XYZ value and measured in cubic feet, which is used to select the appropriate mast arm fabrication plan and foundation design. Preapproved mast arm fabrication plans are available at [Illumination, Signals and ITS - IS | WSDOT \(wa.gov\)](#), and will be listed in the Contract Provisions. To determine the XYZ value for a signal standard, the XYZ value of each appurtenance must be calculated. These values are then totaled to determine the overall XYZ value for the signal standard. For signal standards with two mast arms at 90 degrees apart, the larger of the two XYZ values calculated for each mast arm is used for the overall pole XYZ value.

When determining the XYZ values, use the worst-case scenarios for signal display and sign placements. All signal displays and mast arm-mounted signs, including street name signs, must be included in this calculation. Emergency preemption detectors, preemption indicator lights, cameras, and radar detectors are negligible and are not included in determining the XYZ values. For mast arm-mounted signs, use the actual sign area (in square feet) to determine the XYZ value.

For poles with luminaire supports, the luminaire and arm are also included in the total XYZ calculation. Surface areas for vehicle displays are shown in [Exhibit 1330-25](#). Signs are limited in size as follows:

- Street name signs may be a maximum of 36 inches in height and 36 square feet in total area. Design the mast arm to support the widest sign that will fit within these limits (up to 144 inches wide), regardless of the actual sign size needed. This allows for future changes to the street name sign. Street name signs are mounted such that the edge of the pole is no less than 1 foot but no more than 2.5 feet from the vertical pole centerline, as shown in the [Standard Plans](#). Use the offset necessary for the largest possible sign in the signal standard chart for the XYZ value, but refer to the [Standard Plans](#) for actual sign installation requirements using construction notes in the Contract Plans.
- Other mast arm mounted signs may not exceed 36 inches in height and 7.5 square feet in area.
- Signs mounted on the vertical pole may not exceed 36 inches in width and 15 square feet in area. These signs are not included in the XYZ calculation.

After calculating the total XYZ value, adjust the total XYZ value as follows:

If the total XYZ value is less than or equal to 2850 ft³, round the XYZ value up to the next standard foundation XYZ value or 2850 ft³, whichever is lower, to determine the design XYZ value. The design XYZ builds in some flexibility for future modifications.

- If the total XYZ value exceeds 2850 ft³, use the calculated XYZ value. There is limited opportunity for future increased wind load when the XYZ value exceeds 2850 ft³.

Exhibit 1330-25 Signal Display Surface Areas

Signal Display	Area
Vertical 3-section	9.2 sq ft
Vertical 4-section	11.6 sq ft
Vertical 5-section	14.1 sq ft
5-section cluster	14.4 sq ft

After the total XYZ value is determined, if a standard foundation may be used, select the correct foundation depths for the XYZ values from the table in the [Standard Plans](#), using the next higher total XYZ value. For WSDOT systems, only the 700, 1350, 1900, 2600, and 3000 columns may be used. All five foundation options should be provided unless there is a known constraint preventing the use of one of the options, such as insufficient space for 4 ft diameter foundation or expected loose soil requiring the use of the Alternate 2 foundation construction.

1330.05(3)(b) Span Wire Signal Standards and Foundation Design

Span Wire Systems use poles and aerial wires to support signal displays, signs, and emergency preemption equipment. Cameras, radar detectors, and street name signs are installed on the vertical strain poles. When laying out span wires, the preferred layout is similar to mast arm supports. Displays for an approach should be installed on a span on the far side of the intersection, with poles on the two far corners. Do not use diagonal spans unless absolutely necessary, as they are extremely difficult to maintain and if the wire is broken, the entire signal system is lost and blocks the entire intersection, rather than the equipment for only one approach.

Span wire signal standards include both steel and timber strain poles. Steel and timber strain poles are designated by pole class, which is based on the horizontal tension load the pole will support. The loads and resultant forces imposed on strain poles are calculated and a pole class greater than that load is specified.

Steel Pole Classes and their allowed tension loads are listed in the *Standard Plans*. Exhibit 1330-26 lists the pole classes and tension loading available for timber strain poles.

The Headquarters Transportation Operations Division and Headquarters Bridge and Structures Office support is required for determining span tension load and pole classes. Provide the pole and span layout, the locations and sizes of all signal displays and span wire mounted signs, and the soils report. Span wire mounted signs are limited to a maximum of 36 inches in height and 7.5 square feet in area. Emergency preemption equipment locations do not need to be submitted, as they are not included in load calculations. Spans should not exceed 150 feet, if possible, in order to reduce the complexity of the design.

After the pole classes are provided by the Headquarters Bridge and Structures office, select the appropriate foundation information from the *Standard Plans* using the pole classes and soil conditions. If a standard foundation cannot be used, a foundation design will be provided along with the pole class information.

Exhibit 1330-26 Timber Strain Pole Classes

Pole Class	Tension Load Limit (lbs)
4	2400
3	3000
2	3700
1	4500
H1	5400
H2	6400
H3	7500

Pole Classes from ANSI Standard O5.1

1330.05(3)(c) Special Case Signal Supports

Special case signal supports include signal bridges and structure (typically bridge) mounts. These should only be selected if absolutely necessary, as they are difficult to design, construct, and maintain, and they frequently result in signal display locations that are difficult for drivers to see. Use of these types of supports requires approval from the Headquarters Transportation Operations Division.

Signal bridges function the same as a diagonal span wire system, with the two supports on opposite corners of the intersection. Signal bridges require windload calculations similar to mast arm signal standards, so display and sign locations and offsets must be provided. Signal bridge foundations must be designed by the Headquarters Bridge and Structures office.

Signal displays and other equipment may be installed on structures when there is insufficient clearance below the structure to allow for a different type of signal support. Coordinate with the Bridge designer to place mounts and determine routing paths for conduit and wiring out of the structure. Structure mounts are not desirable, as they typically cannot be modified without reconstruction of the structure itself, and any equipment embedded in the structure is inaccessible after the structure is complete.

Signal displays may not be installed on sign structures such as cantilever sign structures or sign bridges. Signal displays also may not be installed on railroad cantilever structures unless the signal system and the railroad are owned by the same jurisdiction and maintained by the same staff.

1330.05(3)(d) Vertical Steel Shaft Supports

Vertical steel shaft supports include the following types of signal standards:

- a) Type PPB: Sometimes referred to as a “stub pole”, this pole is typically 5 feet tall and 3 inches in diameter. It is used strictly to support pedestrian pushbuttons. Due to the frequency of damage, regardless of location, it is recommended that breakaway bases always be used.
- b) Type PS, I, RM, and FB: These poles are effectively identical, with the difference being the total height to the slipfitter top.
 - Type PS are 8 ft tall and may only have pedestrian displays mounted on the top.
 - Type I are 10 ft tall and may have vehicle displays mounted on the top and pedestrian displays mounted on the side. Type RM are identical to Type I but are used for ramp meter systems only.
 - Type FB are 14 feet tall and may be used like Type I when additional height is needed for the vehicle display(s).

Placement of vertical steel shaft supports will depend on visibility requirements for displays and accessibility requirements of pedestrian features. Generally, these supports should be located at back of sidewalk, as they are farther from traffic and more likely to be out of both the pedestrian access route and the path of any users. Fixed bases should be used when located at the back of sidewalk but slip bases may be used if circumstances recommend it. Supports located within sidewalk (includes planter strips) or in locations with only paved shoulders should always use slip bases.

1330.05(4) Vehicle Detection Systems

Vehicle detection systems are necessary for the efficient operation of traffic signals. By responding to the presence of traffic, signal systems do not have to use fixed timing. This improves efficiency by removing unnecessary delay and not providing service to an approach or movement with no traffic.

1330.05(4)(a) Vehicle Detection Zone Placement

The vehicle detection system at a traffic-actuated signal installation provides the control unit with information regarding the presence or movement of vehicles, including motorcycles and bicycles. Vehicle detection systems perform two basic functions: queue clearance and the termination of phases. Depending on the specific intersection characteristics, either of these functions can take priority. The merits of each function are considered, and a compromise might be necessary.

There are two basic types of detection zones: stop bar and advance. Stop bar detection is a zone that extends from the stop line to a point 30 to 40 feet in advance of that location. Advance detection is a discrete zone (or zones) placed in advance of the stop line at a distance dependent on vehicle speed.

Basic vehicle detection requirements depend upon the speeds of the approaching vehicles:

- a) When the posted speed is below 35 mph, provide stop bar detection or one advance detection zone. See [Exhibit 1330-27](#) for advance detection zone distances.
- b) When the posted speed is at or above 35 MPH, provide stop bar detection and at least two advance detection zones. Multiple advance detection zones are normally required to adequately provide decision zone detection.
- c) Side street advance detection is not required for WSDOT owned signal systems but may be provided through means that do not require equipment to be installed off of WSDOT right of way. For signals owned by other jurisdictions, the use of side street advance detection is at the discretion of the owning jurisdiction.

For posted speeds of 35 MPH or higher, there are two options for placing advance detectors to address the decision zone:

1. Fixed locations based on posted speed, which is generally the 85th percentile speed. Place loops according to the table in [Exhibit 1330-27](#).
2. Calculated locations based on calculated decision zone detection design. This design increases the opportunity for a range of vehicles from the 90th percentile speed vehicle to the 10th percentile speed vehicle to either clear the intersection or decelerate to a complete stop before reaching the intersection. The method of calculating the decision zone and the required detection loops is shown in [Exhibit 1330-28](#).

Although the exhibits reference loops, advance detectors may be of any approved type.

For new intersection construction where there is no existing traffic, the fixed locations based on posted (target design) speed are to be used. Fixed locations based on posted speed use the same methods as the calculated decision zone detection design but set V90 at 5 MPH above posted speed and V10 at 5 MPH below posted speed. Engineering judgment based on similar intersections (such as geometrics and traffic volumes) may justify modifying the V90 and V10 speeds used in the calculation, with concurrence from the region Signal Operations Engineer. Both methods require a study of the approach speeds at the intersection. For intersection approaches, conduct the speed study as follows:

- Collect data at the approximate location or just upstream of the decision zone;
- Collect data during off-peak hours in free-flow and favorable weather conditions;
- Collect data during regular commuting hours in a high-volume signalized corridor during favorable weather conditions
- Only document the speed of the lead vehicle in each platoon.

It is important that the person conducting the speed study remain inconspicuous, so they do not influence drivers to slow down. Normal driving patterns are needed for proper speed studies. Prior speed-study information obtained at this location may be used if it is less than 18 months old and driving conditions have not changed significantly in the area.

Preserve detection zone placements and any supporting calculations as required by Section [1330.08](#) Documentation.

Exhibit 1330-27 Fixed Vehicle Detection Placement

Fixed Detection Placement – Below 35 MPH											Calculated	Rounded
V ₈₅ =		V ₉₀ =		V ₁₀ =		UDZ ₉₀	DDZ ₁₀	LC ₁	P _{MID}	LC ₂	Loop 1	Loop 1
MPH	ft/s	MPH	ft/s	MPH	ft/s	ft	ft	s	ft	s	ft	ft
25	36.7	30	44.00	20	29.33	165.00	50.84	3.9	107.92	1.9	107.92	105
30	44	35	51.33	25	36.67	216.03	70.28	4	143.15	2	143.15	140

For posted speeds below 35 MPH, only the PMID detection location is used.

Fixed Detection Placement – 35 MPH and Above											Calculated		Rounded	
V ₈₅ =		V ₉₀ =		V ₁₀ =		UDZ ₉₀	DDZ ₁₀	LC ₁	P _{MID}	LC ₂	Loop 1	Loop 2	Loop 1	Loop 2
MPH	ft/s	MPH	ft/s	MPH	ft/s	ft	ft	s	ft	s	ft	ft	ft	ft
35	51.33	40	58.67	30	44.00	273.78	92.40	4.1	183.09	2.1	183.09	273.78	180	275
40	58.67	45	66.00	35	51.33	338.25	117.21	4.3	227.73	2.2	227.73	338.25	225	340
45	66	50	73.33	40	58.67	409.44	144.71	4.5	277.08	2.3	277.08	409.44	275	410
50	73.33	55	80.67	45	66.00	487.36	174.90	4.7	331.13	2.4	331.13	487.36	330	490
55	80.67	60	88.00	50	73.33	572.00	207.78	5	389.89	2.5	389.89	572.00	385	575
60	88	65	95.33	55	80.67	663.36	243.34	5.2	453.35	2.6	453.35	663.36	450	665

Exhibit 1330-28 Decision Zone Detection Placement

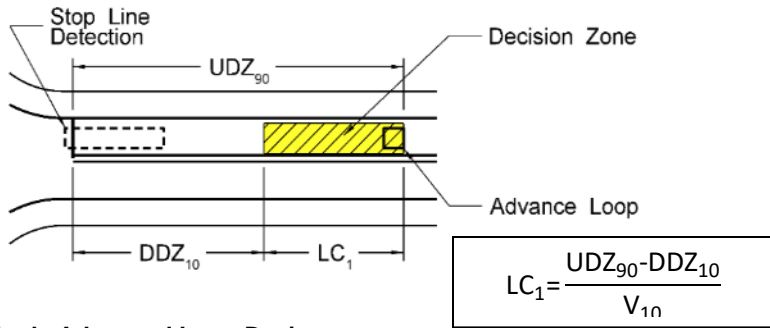

Single Advanced Loop Design

Use when $LC_1 \leq 3$ seconds

Decision Zone Endpoint Calculation

(for all loop arrangements)

Where grades are flatter than +/- 4%:

$$UDZ_{90} = \frac{(V_{90})^2}{16} + V_{90}$$

$$DDZ_{10} = \frac{(V_{10})^2}{40} + V_{10}$$

Where grades are +/- 4% or steeper:

$$UDZ_{90} = \frac{(V_{90})^2}{2(8+32.2G)} + V_{90}$$

$$DDZ_{10} = \frac{(V_{10})^2}{2(20+32.2G)} + V_{10}$$

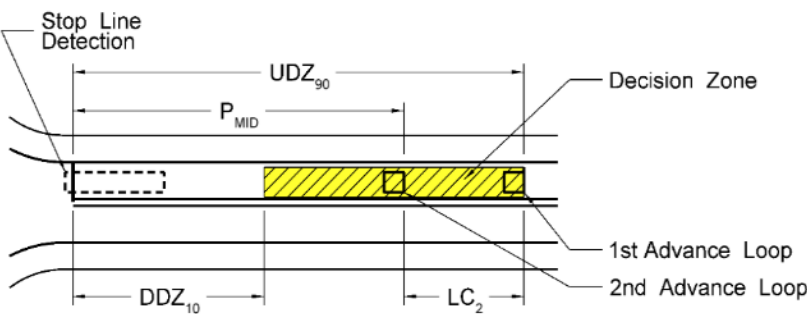

Double Advanced Loop Design

$$P_{MID} = \frac{UDZ_{90} + DDZ_{10}}{2} \quad LC_2 = \frac{UDZ_{90} - P_{MID}}{V_{10}}$$

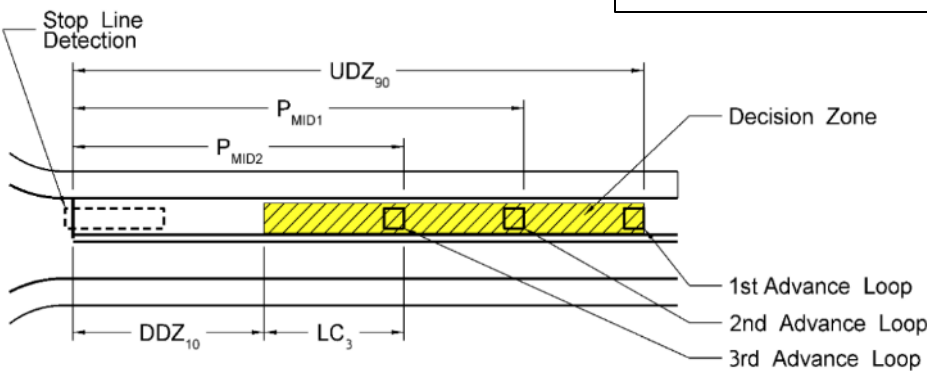

Triple Advanced Loop Design

Use when $LC_3 \leq 3$ seconds

$$LC_3 = \frac{UDZ_{90} - DDZ_{10}}{3V_{10}} \quad P_{MID1} = \frac{[2(UDZ_{90}) + DDZ_{10}]}{3} \quad P_{MID2} = \frac{[UDZ_{90} + 2(DDZ_{10})]}{3}$$

Where:

V_{90} = 90th percentile speed, in feet per second
 V_{10} = 10th percentile speed, in feet per second
 UDZ_{90} = Upstream end of decision zone, for 90th percentile speed
 DDZ_{10} = Downstream end of decision zone, for 10th percentile speed

G = Grade of roadway, in decimal form, including + or - (Example: -4% = -0.04)
 LC_1 = V_{10} travel time to DDZ_{10}
 LC_2 = V_{10} travel time from UDZ_{90} to P_{MID}
 LC_3 = V_{10} travel time from P_{MID2} to DDZ_{10}

1330.05(4)(b) Vehicle Detector Types

There are two basic categories of vehicle detectors:

- **Non-Invasive:** These are detectors installed outside of the roadway, typically overhead in a strategic location. These include camera (optical and infra-red) and radar systems.
- **In-Pavement:** These are detectors which are installed in the road itself. These include induction loops and wireless in-pavement sensors.

Non-invasive detection is generally recommended over in-pavement detection, due to the ability to revise non-invasive detection at any time and the ease of installation, repair, and replacement – particularly when supporting traffic control and impacts are taken into account. Additionally, pavement damage due to regular wear or construction activities will disable in-pavement detection, whereas non-invasive detectors will continue to function, and can even be adjusted to support revised lane configurations.

Stop line detection should use non-invasive systems for detection. Although induction loop detectors are typically the most reliable for detecting cars and trucks, they do not consistently detect bicycles and motorcycles. [RCW 47.36.025](#) specifically requires that vehicle-activated traffic control signals be capable of detecting motorcycles and bicycles.

Advanced detection may be either non-invasive or in-pavement, as these improve efficiency of the signal systems but are not as critical as stop line detection. Non-invasive detection is recommended for posted speeds of 45 MPH or lower, as they are currently only effective for up to about 600 feet from the location of the detector. The advantage is that advance detection can be installed at the intersection, rather than trenching long distances to place advanced detectors in pavement. For speeds over 45 MPH, non-invasive detection systems may be considered, but in-pavement systems will probably be more effective. Advance detection does not need to detect bicycles.

Selection of detector types will depend on a variety of environmental factors and locations available for placement.

1. Radar Detectors

Radar detectors are located on either the signal mast arms or the signal vertical strain poles, depending on lane configuration, detector type, and location availability. Radar detectors are not affected by weather and are typically minimally affected by mast arm motion in high wind. Consult the detector manufacturer's installation guidance for placement details. One detector can normally cover all lanes of an approach for that type of detection (stop line or advance).

2. Video Detectors

Placement of video detectors depends on the function of the detector.

Both infra-red and optical cameras are available, but WSDOT systems may not use optical cameras due to the adverse effects of rain, snow, fog, sun glare, and sharp shadows on their effectiveness. Infra-red cameras may still be affected by heavy fog or other major thermal events, but it is more of a rare occurrence than with optical cameras. All video detection may be affected by mast arm motion due to high winds. [Exhibit 1330-29](#) provides placement examples.

Stop line detectors should be installed on the same mast arm as the vehicle displays for that approach. The detector should be placed on an extension of the wide line between the left turn and through lanes, if present; if there is no wide line, the detector should be centered on the through lanes. One detector can cover all lanes of an approach for that type of detection (stop line or advance).

Advance detectors should be installed on a luminaire arm, preferably on the adjacent corner to the approaching lanes, as the effectiveness of the advance detection depends on height. Consider requiring a luminaire arm even if no luminaire is needed, in order to provide an optimal installation site for the detector. Advance detectors may be installed on a mast arm but will typically have less effective range.

Both infra-red and optical cameras are available, but WSDOT systems may not use optical cameras due to the adverse effects of rain, snow, fog, sun glare, and sharp shadows on their effectiveness. Infra-red cameras may still be affected by heavy fog or other major thermal events, but it is more of a rare occurrence than with optical cameras. All video detection may be affected by mast arm motion due to high winds.

3. Induction Loops

Induction Loops are coils of wire in the roadway that use the magnetic properties of vehicles to detect them. Induction loops can last a very long time when undisturbed. However, induction loops require bicycles to be in a very specific location in order to be detected and may not detect carbon fiber bicycles. Induction loops must be installed with one per lane per detection zone – stop line loops may be larger or series loops. Where induction loops are used, loops need to be numbered in order to keep track of the wiring and lanes they are detecting. See Section [1330.04\(2\)](#) for detector numbering requirements.

4. Wireless In-Pavement Sensors

Wireless in-pavement sensors are compact detectors installed in pavement and use either radar or magnetics to detect vehicles. They use a wireless connection to the signal cabinet. The sensors rely on a battery for operation and require replacement of the entire unit when they fail. Sensor placement is similar to induction loops – one per lane per detection zone. The magnetic versions are subject to the same difficulties with bicycles as loop detectors. All wireless sensors are also subject to various factors that affect wireless signals such as range, signal obstructions, and possible signal interference from other radios depending on the frequency used.

Exhibit 1330-29 Video Detector Placement

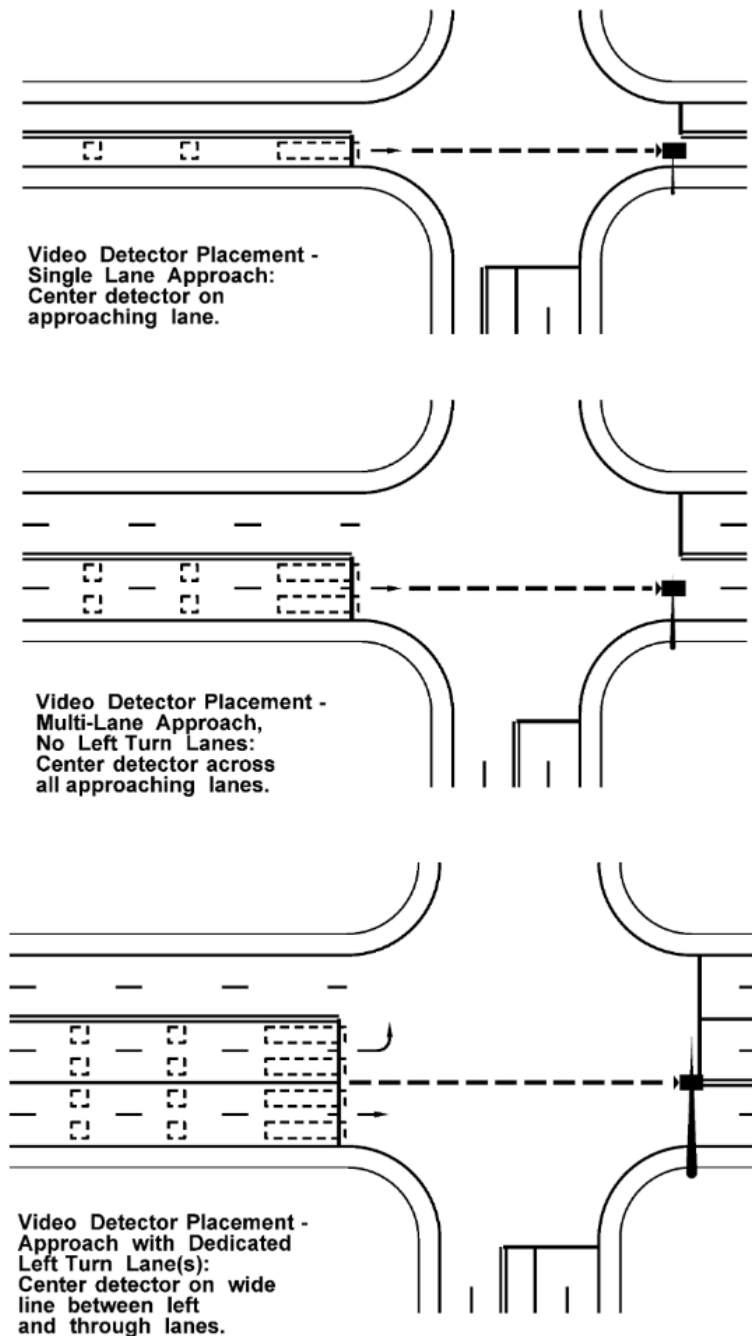

Non-invasive detectors are preferred with concrete (Portland cement concrete pavement) roadway surfaces. In-pavement detectors installed in concrete panels typically cannot be revised or replaced until all affected concrete panels are replaced. In-pavement detectors installed in bridge decks must be installed when the bridge deck is constructed and cannot be replaced unless the bridge deck is replaced. Non-invasive detection is also useful for approaches where advance detection is desired, but the approach is outside the jurisdiction of the agency that owns the signal, or for non-standard approaches such as driveways.

Temporary detection should be installed for all stop lines where existing detection will be disabled or ineffective (such as lane shifts) during construction. Temporary advance detection is recommended for 45 MPH or higher approaches where the decision zone detection will be disconnected for an extended period of time. Consult with the Signal Operations Engineer to determine if temporary advance detection should be used. Temporary advance detection zone placement should take into account any temporary speed limit revisions.

1330.05(5) Preemption Systems

1330.05(5)(a) Emergency Vehicle Preemption

Emergency vehicle preemption (EVP) is required for all traffic signals unless approved otherwise by the Region Traffic Engineer. WSDOT is responsible for installing EVP detection equipment at new and rebuilt signalized intersections on state highways. At existing signalized intersections that do not have EVP detection equipment, or where an emergency service agency requests additional equipment beyond the basic required equipment, the emergency service agency is responsible for all material and installation costs. The emergency service agency is responsible for preemption emitters in all cases.

Optically activated EVP systems are used to ensure compatibility with all area emergency service agency emitters. Approval by the State Transportation Operations Engineer is required for the installation of any other type of emergency vehicle preemption system.

Locate optical detectors facing each approach to the intersection – only one detector per approach – with a clear view of the approaching roadway.

Detectors have a cone of vision of approximately 8 degrees, and an effective range of 200 to 2500 feet.

Detectors should have an unobstructed view of the approach for a minimum of 1800 feet.

Primary detectors are normally installed on the same support as the vehicle displays for that approach. Place the detector between the left turn lane and through lane displays on approaches with left turn lanes, or centered on the approaching lanes where left turn lanes are absent.

When the approach is in a horizontal or vertical curve, or there are other sight obstructions, non-standard placement of the primary detector or additional supplemental detectors may be necessary. Primary detectors may be located on other signal display supports (arms or spans) or vertical strain poles, depending on visibility requirements. Supplemental detectors may also be located on separate Type I or Type FB poles in advance of the intersection. On higher speed roadways, supplemental detectors can provide extended detection range – one mile in advance of the intersection is usually sufficient.

Preserve any documentation associated with the EVP system, including system type selected and any associated agreements or approvals, as required by Section [1330.08](#) Documentation.

1330.05(5)(b) Railroad Preemption

Railroad preemption is used when a railroad is in close proximity to a signalized intersection. If railroad tracks are within 1/4 mile of a signalized intersection, then a Railroad Crossing Evaluation Team is formed to determine the need (if any) for railroad preemption, interconnection, simultaneous preemption, advanced preemption, and so on. The Railroad Crossing Evaluation Team should consist of the Region and HQ Signal Design Engineers, Region and HQ Signal Operations Engineers, HQ Railroad Liaison, HQ Rail Office representative, Region Utilities Engineer, Region Transportation Operations Design Engineer, Region Maintenance Superintendent, and the affected Railroad Liaison. Where the signal is owned, operated, or maintained by a local agency, a local agency representative should also be included.

The Railroad Crossing Evaluation Team will determine what design considerations are needed at all signalized intersections near railroad crossings. For locations where the railroad tracks are located greater than 500 feet from the signalized intersection, and it can be demonstrated that the 95% maximum queue length(s) will not extend to within 200 feet of the tracks, railroad preemption may be omitted with the approval of the Railroad Crossing Evaluation Team. Include the demonstration and approval in the documentation required by Section [1330.08](#) Documentation.

Railroad preemption and interconnection are recommended when any of the following conditions occurs:

- The distance from the stop bar to the nearest rail is less than or equal to 200 feet.
- There is no dedicated left turn lane and the distance from the stop bar to the nearest rail is less than or equal to 500 feet.
- The 95% maximum queue lengths from the intersection stop bar are projected to cross the tracks. (Use a queue arrival/departure study or a traffic analysis “micro-simulation model” to determine 95% maximum queue lengths.)
- The 95% maximum queue lengths from the railroad are projected to affect an upstream traffic signal. (Use a queue arrival/departure study or a traffic analysis “micro-simulation model” to determine 95% maximum queue lengths.)

If it is determined that advanced preemption is needed, the HQ and region Signal Operations Engineers will calculate the amount of railroad preemption time required using the [WSDOT Railroad-Traffic Signal Preemption Timing Worksheet](#).

The addition of a pre-signal is recommended when any of the following conditions occurs:

- The distance from the stop bar to the nearest rail is less than 88 feet but is at least 40 feet. (For reference, the 88 feet is derived from: the longest design vehicle permitted by statute (75 feet) + front overhang (3 feet) + rear overhang (4 feet) + downstream clear storage (6 feet)).
- The distance from the stop bar to the nearest rail is > 88 feet and < 120 feet and there are no gates for the railroad crossing.
- The sight distance triangle in [Chapter 1350, Exhibit 1350-1](#) (Sight Distance at Railroad Crossing), cannot be met, and the railroad crossing does not have active control (lights or gates).

When pre-signals are used, two stop lines are used: one for the rail crossing, and one for the intersection. The pre-signal displays stop traffic at the rail crossing stop line, and the second set of signal displays stop traffic at the intersection. Use louvers on the intersection displays so that they are not visible from the stop line for the rail crossing. Optically programmed displays may be used in place of louvers, but are not recommended due to the limited benefits, complexity of installation and maintenance, and high cost.

Where the distance between the normal location for the stop bar and the approach is less than 40 feet, the same stop bar should be used for both the traffic signal and the rail crossing. Install vehicle displays on the near side of the intersection, but on the far side of the tracks from the stop line, to improve visibility and discourage drivers from stopping between the tracks and the intersection. Do not install vehicle displays on the far side of the intersection.

[Exhibit 1330-30](#) shows examples of the distances and typical system layouts referenced above.

The Railroad Crossing Evaluation Team has final review and approval authority for all PS&E documents for signal design and operation at all signalized intersections near railroad crossings. All documentation associated with railroad preemption and a memo with each team member’s concurrence with the PS&E documents must be preserved as required by Section [1330.08](#) Documentation.

Exhibit 1330-30 Signal Display Layout for Rail Crossings

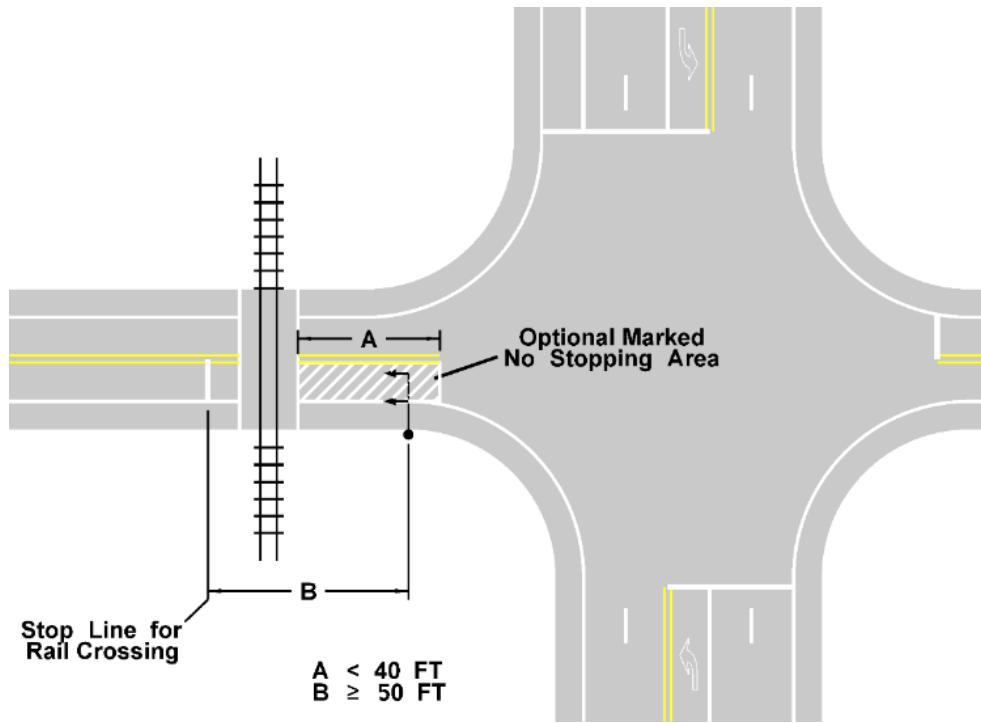

Display Placement – Less than 40 feet between tracks (dynamic envelope marking) and intersection

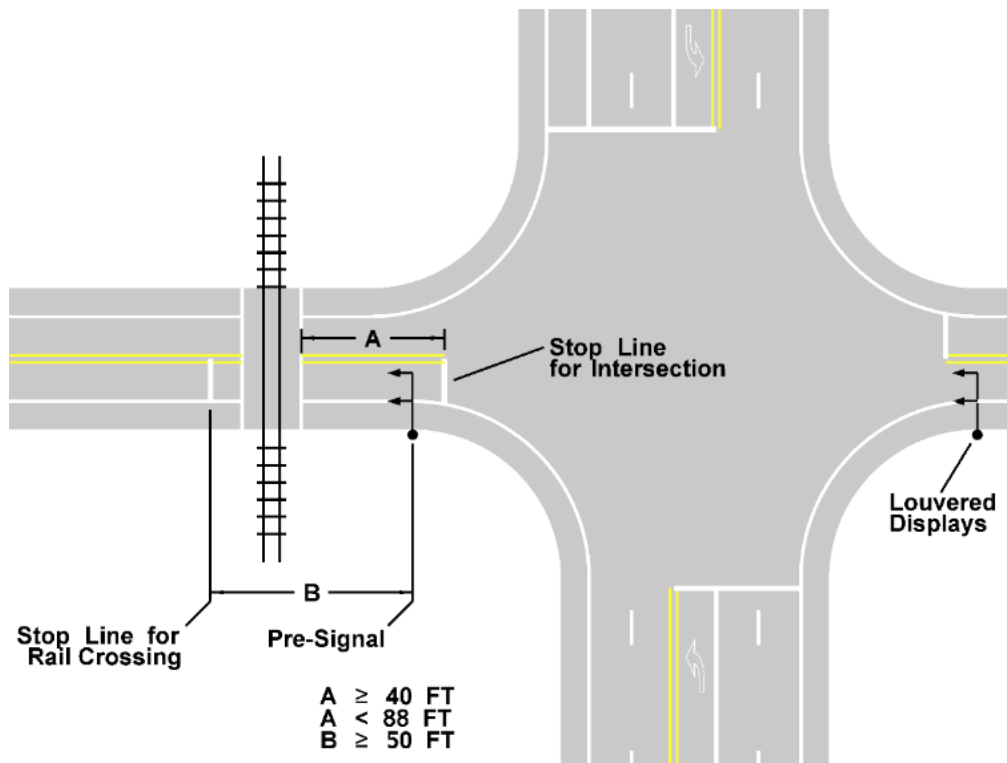

Display Placement – 40 to 88 feet between tracks and intersection

1330.05(5)(c) Transit Priority Preemption

Transit Priority Preemption allows for transit operations to influence signal timing, similar to emergency vehicle preemption. This can be included in mobility projects, but the transit agency assumes all costs for providing, installing, and maintaining this preemption equipment. WSDOT's role is limited to approving preemption operational strategies (phasing, timing, software, and so on) and verifying the compatibility of the transit agency's equipment with the traffic signal control equipment. Preserve all transit priority preemption decisions and agreements as required by Section [1330.08](#) Documentation.

1330.05(6) Control Equipment

The standard WSDOT Signal Controller type for traffic signals is the Type 2070 Controller. Some agencies use National Electrical Manufacturers Association (NEMA) controllers (Type TS1 or TS2). Although not normally used for new construction, WSDOT Ramp Meters and some older systems still use Type 170 Controllers. All traffic signal controllers have the following basic functions:

- Dual ring phase operation
- Eight vehicle phases
- Four pedestrian phases
- Four overlap phases
- Four emergency vehicle preemption channels
- Railroad preemption
- Start and end daylight savings time dates
- Transit preemption (some older controllers may not support this)

Type 2070 controllers and newer NEMA controllers are functionally equivalent for basic signal operations. However, Type 2070 controllers and NEMA controllers use different operating software and communications protocols, and therefore cannot be interconnected together. The type of controller should be specified as follows:

1. For WSDOT traffic signals, specify Type 2070 controllers, unless:
 - a. The signal is interconnected with other signals. If the other controllers in the interconnected system are not being replaced, specify a controller (2070, NEMA, or other) that matches the rest of the interconnected system.
 - b. The signal is operated by another agency. In this case, work with WSDOT and the other agency's maintenance staff to determine the appropriate controller type.
2. For traffic signals owned by other agencies, specify the controller type used by that agency.

The region or operating agency will determine the controller brand and operating software, which are included in the cabinet specifications. Each region or operating agency will provide specifications for their cabinets and the equipment contained therein. For 2070 controllers, double-width cabinets (two racks) should be specified if physically possible to allow for future communications and ITS equipment.

It is often beneficial for one of the agencies to assume responsibility for the operation of the traffic signals. This is accomplished by negotiating an agreement with the other agency. The designer needs to check region policy and make sure someone initiates the process for setting up an operational agreement with the other agency or modifying an existing agreement when applicable. See the [Agreements Manual](#) for more information on signal systems and maintenance agreements (Consultants: Please contact your WSDOT Project Manager for access to the Agreements Manual).

At a new intersection, where the state owns the signal, but WSDOT has agreed to let another agency operate the signal, the controller should be compatible with that agency's system. When installing a new controller in an existing interconnected corridor, the controller should be capable of operating with the existing controllers in the corridor. In situations where it is necessary to coordinate the traffic movements with another agency, it is important that the agencies work together.

Intersections within ½ mile of each other on state highways should be interconnected. Perform an operational analysis to determine need for interconnection where intersections are within 1 mile of each other on state highways with a posted speed of 45 MPH or higher. The preferred method for interconnection is fiber optic cable, but other methods such as IP over copper or wireless interconnect may be considered after discussion with maintenance staff and approval by the Region Traffic Engineer. Where fiber optic cable is used, it must be routed through pull boxes and cable vaults – bending fiber optic cable through standard junction boxes typically results in the cable being broken. Consider using a separate pull box or vault for coiling the fiber optic interconnect cable to allow for the large-bend radii. Add a construction note in the plans stating to coil additional cable in the adjacent pull box or vault, not the controller cabinet. This will save on space in the controller cabinet and provides additional cable in case an errant vehicle hits the cabinet.

Coordinate with the operations and maintenance staff to determine the optimum controller cabinet location and the cabinet door orientation. The controller cabinet is positioned to provide the best maintenance access and clearest view of the intersection possible. Preferred visibility allows for as many signal displays and roadway approaches visible as possible from a single location. Cabinets should not be placed where they might block the view of turning traffic (intersection sight triangle). If possible, position the controller where it will not be affected by future highway construction.

Cabinets require a minimum of 36 inches of level space in front of each door, including the concrete pad. Do not place cabinets where flooding might occur or where the cabinet might be hit by errant vehicles. If there is a steep down slope or drop off near the cabinet, personnel fall protection (such as fencing) is required in accordance with standards established by the Department of Labor and Industries. Fall protection may not encroach on the required clear space for the cabinet. The location must also have adequate room for a maintenance vehicle to park near the cabinet. Sufficient space for a bucket truck to park is preferable.

If a telephone line (voice or DSL), fiber optic, wireless, or other connection is desired for remote access to the equipment in the cabinet, provide the appropriate equipment in the controller cabinet and/or nearby junction box or cable vault with separate conduits and junction boxes for the remote communications equipment. Communications connections to outside utilities require their own separate conduit and box/vault system.

Consult with maintenance and operations staff to determine if a backup power source, such as an Uninterruptible Power Supply (UPS) or backup generator, is needed for the signal cabinet. Install the backup power supply on the same concrete pad as the signal cabinet. Service and other cabinets may also be installed on the same concrete pad as the signal cabinet (see the [Standard Plans](#) for concrete cabinet pad layouts). Refer to [Chapter 1040](#) for electrical service types, overcurrent protection, and descriptions and requirements for other components.

1330.05(7) Wiring, Conduit, and Junction Boxes

Consider cost, flexibility, construction requirements, and ease of maintenance when laying out the electrical circuits for the traffic signal system. Consolidate roadway crossings (signal, illumination, ITS conduits, and so on) whenever possible to minimize the number of crossings and take advantage of single crossing construction (joint trenches or consolidated directional boring). Include all electrical design calculations in the Project File.

1330.05(7)(a) System Wiring

Traffic signal systems use multi-conductor cables to connect most of the equipment. Single conductor cable is limited to cabinet power and street lighting circuits.

The following describes typical WSDOT wire type selection:

- 5c cables for signal displays. One 5c per signal phase may connect the signal cabinet to the terminal cabinet on the pole. Separate 5c cables should connect each signal display to the terminal cabinet. Protected / permissive displays may either use one 7c cable or two 5c cables (one for each phase on the shared display).
- 5c cables for pedestrian displays. Consult with region maintenance to determine if the same 5c cable is used for associated pedestrian detection.
- 3cs cables for emergency preemption detectors.
- 2c cables for induction loop detectors. Shielded cable is not required for modern loop detector cards. Older systems may still need shielded cable (2cs), but it is recommended to replace the loop detector cards instead.
- Manufacturer specified cables for video and radar detectors. Video detectors typically use a combined RG9/5c (#18) cable. Radar detectors typically use proprietary 6c and 8c cables. These cables are roughly the size of 7c cables (for calculating conduit fill).
- Use 2c cables for isolated pedestrian detectors (separate pole from associated pedestrian display). For connecting 4-wire APS units, a 7c cable may be used between the PPB post and the signal pole with the pedestrian display (where the APS control unit is located).

To simplify potential repairs for smaller signal standards (Type FB and smaller), consider routing signal display and detection conductors through terminal cabinets on larger signal standards (Type II and larger) before connecting to smaller signal standards. This reduces the amount of wire which may need to be replaced if a smaller signal standard is knocked down and the wiring damaged.

1330.05(7)(b) Conduit

Refer to the [Standard Specifications](#) for conduit installation requirements. At existing intersections, where roadway reconstruction is not proposed, conduits are to be placed beyond the paved shoulder or behind existing sidewalks to reduce installation costs. All conduits shall be a minimum of 2 inches in size, with the following exceptions:

1. Conduits entering Type PPB signal standards shall be 1 inch. This may be increased to 1 1/4 inch when two APS PPBs are installed on the same pole.
2. Lighting conduits entering pole foundations (signal or light standards) shall be a minimum of 1 inch. See [Chapter 1040](#) for additional requirements for light standards with slip bases.
3. Conduits entering Type PS, I, RM, and FB poles may be a minimum of 1-inch and a maximum of 2-inch.
4. The conduit for the service grounding electrode conductor may be a minimum of ½-inch.

Install spare conduits at all road crossings. Spare conduits at road crossings should be a minimum of one 3-inch conduit or two 2-inch conduits. Install a minimum 2-inch (preferably 3-inch) spare conduit into the controller cabinet.

It is recommended to use full inch conduit sizes to simplify construction and reduce the different types of conduits required for the system. This helps to provide future capacity and reduce costs through bulk material purchasing. Size all conduits to provide 26% maximum conductor fill for new signal installations. A 40% fill area can be used when installing conductors in existing conduits. (See [Exhibit 1330-31](#) for conduit and signal conductor sizes.)

Exhibit 1330-31 Conduit and Conductor Sizes

Conduit Sizing Table			
Trade Size	Inside Diam. (inches)	Maximum Fill (inch ²)	
		26%	40%
1/2"	0.632	0.08	0.13
3/4"	0.836	0.14	0.22
1"	1.063	0.23	0.35
1 1/4"	1.394	0.40	0.61
1 1/2"	1.624	0.54	0.83
2"	2.083	0.89	1.36
2 1/2"	2.489	1.27	1.95
3"	3.09	1.95	3.00
3 1/2"	3.57	2.60	4.00
4"	4.05	3.35	5.15

Conductor Size Table			
Size (AWG)	Area (inch ²)	Size (AWG)	Area (inch ²)
# 14 USE	0.021	2cs (# 14)	0.090
# 12 USE	0.026	3cs (# 20)	0.070
# 10 USE	0.033	4cs (# 18)	0.060
# 8 USE	0.056	5c (# 14)	0.140
# 6 USE	0.073	7c (# 14)	0.170
# 4 USE	0.097	10c (# 14)	0.290
# 3 USE	0.113	6pcc (# 19)	0.320
# 2 USE	0.133		

Minimize roadway crossings whenever possible. Usually only three crossings are needed (one main line) for a four-leg intersection, and only two roadway crossings are needed for a T intersection. In most cases, the conduit should cross both the main line and side street from the corner where the controller is located.

Directional boring should normally be used when crossing the state route (main line). Open cut trenching may only be used to install conduits under the following circumstances:

1. Existing roadways where the roadway is being resurfaced.
2. Existing roadways where substantial obstacles under the roadway will be encountered.
3. Where there is insufficient room for jacking or boring pits at the edges of the roadway.

Open cut trenching is not permitted across limited access roadways unless the entire pavement surface is being replaced. Sign or signal bridges may not be used for roadway crossings.

1330.05(7)(c) Junction Boxes

Provide junction boxes at the following locations:

- Adjacent to the signal cabinet. A pull box or larger vault may be used in place of multiple junction boxes.
- Adjacent to each signal pole. One box may serve multiple poles. The distance from a pole to the first junction box should not exceed 10 feet without concurrence from maintenance staff. Pole bases may not be used as junction boxes.
- Adjacent to each set of detector loops. These boxes contain the detector loop splices. One box may serve multiple lanes, but the box should be no more than 50 feet from the detector loop.
- At the end of each road crossing.
- In the middle of conduit runs where the number of bends would equal or exceed 360°.

Where possible, locate junction boxes out of paved areas and adjacent to (but not in) sidewalks. New junction boxes may not be placed in the pedestrian curb ramp or ramp landing of a sidewalk. If a new junction box must be placed within sidewalk, locate it at the edge of the sidewalk and designate it to be slip-resistant. Existing junction boxes located within new or existing sidewalk, including ramps or landings, must be revised as follows:

- Existing junction boxes containing power conductors for the traffic signal (not including street lighting), or wiring for the signal displays, may remain in place, even if they will be within a sidewalk ramp or ramp landing.
- Existing junction boxes containing detector wiring may remain in sidewalks but must be relocated outside of sidewalk ramps and ramp landings. Designate that the relocation work, including conduit adjustments and rewiring, be completed within a single shift or provide temporary detection using another conduit path.
- All junction boxes which will be within sidewalk, sidewalk ramps, or ramp landings, must be slip-resistant junction boxes. This includes replacing existing junction boxes with slip-resistant junction boxes.
- Under no circumstances may a junction box be located in a grade break for a sidewalk ramp. Either the ramp must be redesigned or additional accommodations made in construction to allow for the box to be relocated.

The fundamental principle is that if relocating a junction box requires shutting down a traffic signal system, the junction box may remain in its existing location but must be replaced with a slip-resistant junction box. See [Chapter 1510](#) for additional ADA requirements.

Do not place junction boxes within the traveled way unless absolutely necessary. Make every effort to locate new junction boxes and to relocate existing junction boxes outside the travel lane or paved shoulder. If there is no way to avoid locating the junction box in the traveled way or paved shoulder, heavy-duty junction boxes must be used. Avoid placing junction boxes in areas of poor drainage. Do not place junction boxes within 2 feet of ditch bottoms or drainage areas, or within vegetative filter strips or similar water treatment features which may be present. The maximum conduit capacities for various types of junction boxes are shown in the [Standard Plans](#).

1330.06 Preliminary Signal Plan

All traffic signal work which installs or modifies detection or display equipment, with the sole exception of projects where induction loops are being removed and replaced in the same location, requires a preliminary signal plan for the Project File. The type of preliminary signal plan depends on the type of work being performed. For a new traffic signal system or complete system replacement, a Full Preliminary Signal Plan is required. For all other work, a Basic Preliminary Signal Plan is required. Include a brief discussion of the issue that is being addressed by the project. Provide sufficient level of detail on the preliminary signal plan to describe all aspects of the signal installation, including proposed channelization modifications. The plan scale should not be smaller than “1 inch = 30 feet” (“1 inch = 20 feet” is preferable) – plans may be reduced to “1 inch = 40 feet” with prior approval.

Submit a copy of the preliminary signal plan to the State Transportation Operations Engineer for review and comment. A preliminary signal plan must be submitted to the State Transportation Operations Engineer regardless of the originator of the design. Allow two to three weeks for review of the preliminary signal plan. After addressing all review comments, finalize the plan and preserve as required by Section [1330.08](#) Documentation. Prepare the contract plans in accordance with the [Plans Preparation Manual](#).

If HQ Transportation Operations Division is preparing the contract Plans, Specifications, and Estimate (PS&E) package for the signal system portion of the project, submit the following items with the preliminary signal plan:

- Contact person.
- Charge numbers.
- Critical project schedule dates.
- Existing and proposed utilities, both underground and overhead.
- Existing intersection layout, if different from the proposed intersection.
- (Turning movement traffic counts (peak hour for isolated intersections) and a.m., midday, and p.m. peak-hour counts if there is another intersection within 500 feet.
- Electrical service location, source of power, and utility company connection requirements.

After the PS&E package for the signal system portion of the project is prepared, the entire package is transmitted to the region for incorporation into its contract documents.

1330.06(1) Basic Preliminary Signal Plan

The Basic Preliminary Signal Plan includes the following elements, at a minimum:

- All pavement markings.
- Sidewalks, curb ramp, and level landing areas.
- All pole types and locations.
- All vehicle and pedestrian display types and locations.
- All vehicle (car and/or bicycle) detector types and locations. Include detection zones for non-loop detectors.
- All pedestrian pushbutton types and locations.
- All emergency vehicle preemption (EVP) detector locations.
- Phase diagram, including pedestrian movements and EVP channel assignments.

1330.06(2) Full Preliminary Signal Plan

The Full Preliminary Signal Plan includes all elements required for the Basic Preliminary Signal Plan, with the following additional items (list is continued from above):

- Cabinet locations with door orientations.
- Traffic barrier (guardrail, concrete barrier, etc.) locations.
- Drainage items.
- Left-turn radii, including beginning and ending points.
- Corner radii, including beginning and ending points.
- Railroad preemption requirements.
- Illumination treatment, including a calculation summary showing the average light level, average/minimum uniformity ratio, and maximum veiling luminance ratio. (See [Chapter 1040](#) for more information on illumination design requirements.)
- Traffic counts, including left-turn movements.
- Speed study information indicating 90th, 85th, and 10th percentile speeds for all approaches. For any new approach, or any approach where the existing speed will change, the design posted speed may be provided instead.
- Utilities information, for any potential overhead or underground utility conflicts.

1330.07 Operational Considerations for Design

This section describes operational guidance for traffic signals. These operational requirements will directly affect the design of the traffic signal, particularly in regard to signal display types and locations.

All traffic signals should be periodically re-evaluated, to determine if timing or phasing changes would result in more efficient operation of the traffic signal, or in the case of interconnected systems, the corridor or network. Changes in traffic volumes, posted speeds, or other factors may influence turning movement phasing operations (protected, protected/permissive, or permissive), green times, yellow change intervals, and other operational parameters.

1330.07(1) Left-Turn Phasing

Left-turn phasing can either be permissive, protected/permissive, or protected. It is not necessary that the left-turn mode for an approach be the same throughout the day. Varying the left-turn mode on an approach among the permissive only, protected/permissive, and protected-only left-turn modes during different periods of the day is acceptable. Examples are included in the phase diagrams shown in [Exhibit 1330-32](#) and [Exhibit 1330-33](#).

For permissive left turns, including the permissive portion of a protected/permissive left turn, the permissive left turn phase shall not terminate separately from the conflicting phase(s) (typically, the opposing through phase). This is to prevent placing left turning traffic in a yellow trap.

1330.07(1)(a) Permissive Left-Turn Phasing

Permissive left-turn phasing requires the left-turning vehicle to yield to opposing through traffic and pedestrians. Permissive left-turn phasing is used when the following are true:

- Turning volume is minor.
- Adequate gaps occur in the opposing through movement.
- Adequate sight distance beyond the intersection is provided.

This phasing is more effective on minor streets where providing separate protected turn phasing might cause significant delays to the higher traffic volume on the main street. On single-lane approaches with a posted speed of 45 mph or above, or where sight distance approaching the intersection is limited, channelization should include a separate left-turn storage lane for the permissive movement to reduce the potential for rear-end-type collisions and delay to through movements.

Unless there is a dedicated left-turn lane, do not provide a separate display for permissive left turns. When there is a dedicated left-turn lane, a three-section flashing yellow arrow display (with steady red arrow, steady yellow arrow, and flashing yellow arrow displays) should be used for the left-turn lane, as this provides a more positive indication of the permissive turning movement.

1330.07(1)(b) Protected/Permissive Left-Turn Phasing

Protected/permissive left-turn phasing provides both a protected phase and a permissive phase for the same lane, using the same signal display. Where left-turn phasing will be installed and conditions do not warrant protected-only operation, consider protected/permissive left-turn phasing. Protected/permissive left-turn phasing can result in increased efficiency at some types of intersections, particularly “T” intersections, ramp terminal intersections, and intersections of a two-way street with a one-way street where there are no opposing left-turn movements.

Protected/permissive left-turn phasing is NOT allowed under the following conditions:

- For new signals, on an approach where Warrant 7 is met (see Section [1330.02\(1\)\(a\)](#)) and there are five or more left-turning collisions on that approach included in the warranting collisions. This condition requires protected left turn phasing.
- For existing signals, when documentation shows that existing protected left-turn phasing was installed due to left-turn collisions.
- When sight distance for left-turning vehicles, as outlined in AASHTO’s *A Policy on the Geometric Design of Highways and City Streets*, cannot be met.
- On intersection approaches where the opposing approach has three or more lanes (including right-turn lanes) and either the posted speed limit or 85th percentile speeds for the opposing approach are at or above 45 mph.
- On intersection approaches that have dual left-turn lanes, including approaches with left only and through-left lanes.

Where there is a separate left-turn lane, protective/permissive displays may use either of the following display arrangements:

- A dedicated four-section arrow display, with steady red arrow, steady yellow arrow, flashing yellow arrow, and steady green arrow displays (four-section FYA). A three-section display with a bi-modal flashing yellow arrow / steady green arrow may only be used if the signal support does not have sufficient capacity for a four-section signal display.
- A shared five-section cluster (doghouse) display, placed over the wide line between the left turn lane and the adjacent through lane. Cluster displays may not be used for WSDOT signal systems.

Where there is no separate left-turn lane, only a five-section vertical (recommended) or cluster display may be used. The five-section display is used in place of the left of the two required through displays for that approach.

Protected/permissive displays may run as lead or lag. The display cycle will depend on the display type and whether the protected left leads or lags:

- Leading 4-section FYA: steady green arrow, steady yellow arrow, steady red arrow, flashing yellow arrow, steady yellow arrow, steady red arrow.
- Leading 5-section: green arrow, yellow arrow, red ball, green ball, yellow ball, red ball. Option: green ball may come up with green arrow, but the arrow and ball displays should cycle to yellow and red together (similar to lagging 5-section)
- Lagging 4-section FYA: flashing yellow arrow, steady green arrow, steady yellow arrow, steady red arrow
- Lagging 5-section: green ball, green ball with green arrow, yellow ball with yellow arrow, red.

1330.07(1)(c) Protected Left-Turn Phasing

Protected left-turn phasing provides the left-turning vehicle a separate phase, and conflicting movements are required to stop.

Use protected left-turn phasing under the following conditions:

- Multi-lane left turn movements, including left and through-left from the same approach.
- The left-turn is onto a roadway with a rail crossing.
- Where Warrant 7 is met and there are five or more left-turning collisions on that approach included in the warranting collisions. Protected left-turn phasing is recommended even when there are as few as three left-turning collisions on that approach. This includes left-turning collisions involving pedestrians.
- Where the peak-hour turning volume exceeds the storage capacity of the left-turn lane and one or more of the following conditions is present:
 - The posted speed or the 85th percentile speed of the opposing traffic is 45 mph or higher.
 - The sight distance to oncoming traffic is less than 250 feet when the posted or 85th percentile speed is 35 mph or below, or less than 400 feet when the posted or 85th percentile speed is above 35 mph.
 - The left-turn movement crosses three or more lanes (including right-turn lanes) of opposing traffic.
 - Geometry or channelization is confusing, such as skewed intersections, offset-T intersections, or intersections which require unusual maneuvers to traverse.

There are three typical operational arrangements for protected left turns:

- Leading Lefts: The left turns are served before the associated through movements. This is the most common operational arrangement. Example: Phases 1 and 5 (major street lefts) are served first, then phases 2 and 6 (major street throughs) are served.
- Lagging Lefts: The left turns are served after the associated through movements. Example: Phases 4 and 8 (minor street throughs) are served first, then phases 3 and 7 (minor street lefts) are served.
- Offset (or Lead/Lag) Lefts: One left turn is served before the associated through movements, and the opposing left turn is served after the associated through movements. Example: Phase 1 (one major left turn) is served first (phase 6 may be served at the same time), then phases 2 and 6 (major throughs) are served, and then phase 5 (opposing major left turn) is served (phase 2 may still be served with phase 5).

Check that all turning movements provide turning clearance for opposing turn phases. If the opposing left-turning vehicle paths do not have 4-foot minimum—12-foot desirable—separation between them, split or offset (lead/lag) phasing will have to be used.

1330.07(2) Right-Turn Phasing

Right turns typically do not operate with their own phasing unless there is a dedicated right turn lane. When there is no dedicated right turn lane, right turns are normally a permissive movement from the right most through lane, depending on pedestrian phases in use. When there is a dedicated right turn lane, right-turn phasing effectively operates the same as left-turn phasing.

Dedicated right turn lanes may be operated the same as left turn lanes: permissive, protected/permissive, or protected. However, right turn phase operation needs to take into account any pedestrian crossing on the receiving side of the right turn. If there is a conflicting pedestrian phase – typically a pedestrian phase running concurrent with the through phase from which the right turn is being made – the right turn phase may only be operated as permissive.

Dedicated right turn lanes operated as permissive and protected/permissive shall have their own displays, to avoid any confusion when indications are shared with the adjacent through lane, unless justification for not providing a separate display is given. Dedicated right turn lanes operated as protected must use their own display. Right turn displays are arranged and operated the same as those listed for left turns in Section [1330.07\(1\)](#). As with left turns, a permissive right turn phase shall not terminate separately from the conflicting phase(s) (typically, the opposing through phase).

Separate right turn phasing also needs to consider some additional operational modes and issues:

1330.07(2)(a) Right-Turn Overlapped Phasing

A right turn overlap is when a protected right turn is allowed at the same time as a complementary protected left turn and is recommended when the lane and phase configuration will support this operation. When this operation is used, the left turn must be signed that U-turns are prohibited.

When right turn overlaps are used, the wiring of the right turn displays will depend on the operating mode of each display section:

- Permissive: Connect permissive display sections to the same terminals as the associated through phase.
- Protected: Protected display sections may either be:
 - Connected to the complementary left turn phase. Use this arrangement when the protected right turn will only be run concurrent with the complementary left turn phase.
 - Connected to an overlap phase. Use this arrangement when the protected right turn will be run with both the complementary left turn phase and with the through phase associated with the right turn.

1330.07(2)(b) Multiple-Lane Right-Turn Phasing

Multiple-lane right turns may be run independent or overlapped as described above. Multiple-lane right turns can cause operational challenges when “right turn on red” is permitted at the intersection. Verify that there is adequate sight distance and adequate receiving lanes are available to minimize the possibility of collisions. In most cases, a single unrestricted “right-turn-only” lane approach with a separate receiving lane (auxiliary lane) will have a similar capacity as the two lane right-turn phasing.

1330.07(3) Typical Signal Phasing Arrangements

The following diagrams show typical phasing diagrams for four-way and three-way intersections.

Exhibit 1330-32 Phase Diagrams: Four-Way Intersections

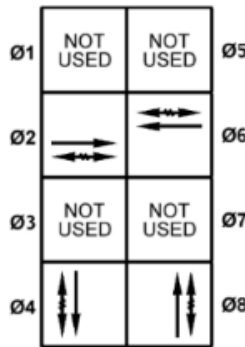
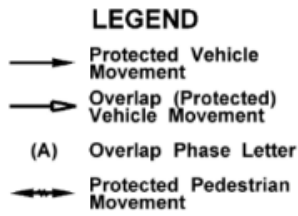

Basic Four Phase Operation
All permissive left turns

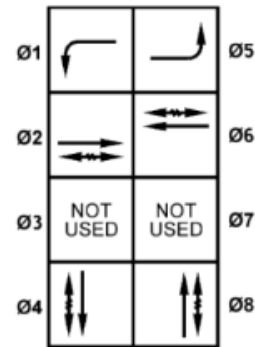

Six Phase Operation
Main Street protected lefts
Minor Street permissive lefts

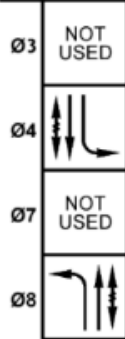
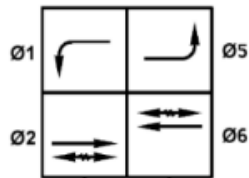

*With modern controllers, split phases can be run from either the through or the left turn phase.

Split Phase (Six Phase) Operation*
Main Street protected lefts
Minor Street split - protected lefts with concurrent through

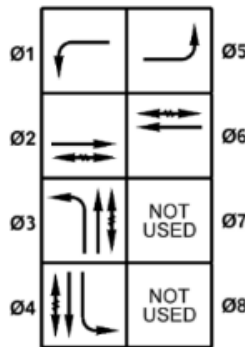

Split Phase (Six Phase) Operation* (Alternate Arrangement)
Main Street protected lefts
Minor Street split - protected lefts with concurrent through

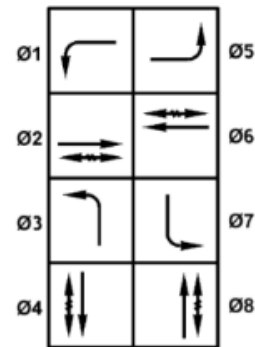

Eight Phase Operation: Typical
Leading protected left turns

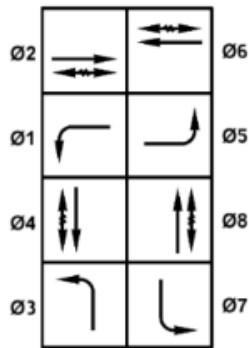

Eight Phase Operation: Lagging Lefts
Lagging protected left turns

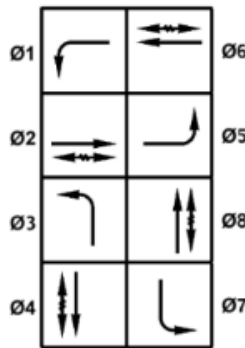

Eight Phase Operation: Split Lefts
Opposing left turns split between leading and lagging

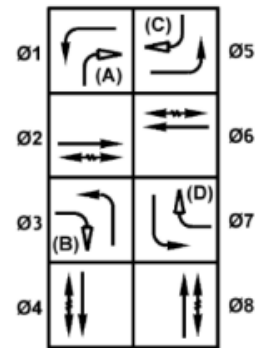

Eight Phase Operation: Overlaps
Leading protected left turns with overlapped protected right turns. Right turns may be permissive with associated through phase.

If right turns are protected with concurrent through phase, negative pedestrian overlaps must be used.

Exhibit 1330-33 Phase Diagrams: Three-Way Intersections

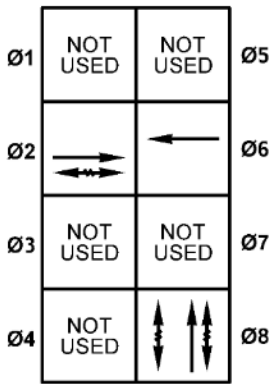

Basic Three Phase Operation
All permissive turns

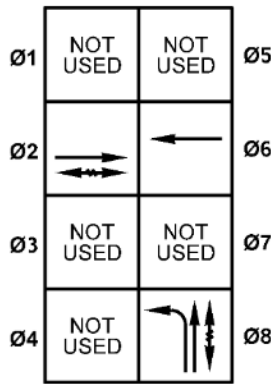

**Three Phase Operation:
Restricted Peds**
Protected left turn from side street by removing conflicting pedestrian phase (and crossing)

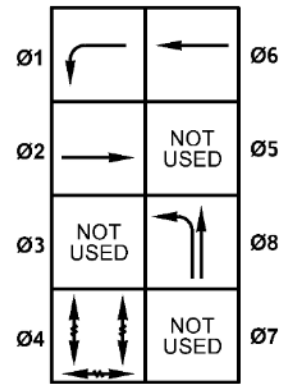

**Five Phase Operation:
Exclusive Peds**
All pedestrian crossings run together as separate phase

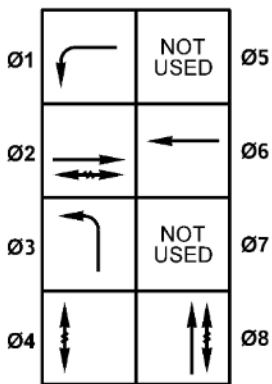

**Six Phase Operation:
Typical**
Leading protected left turns

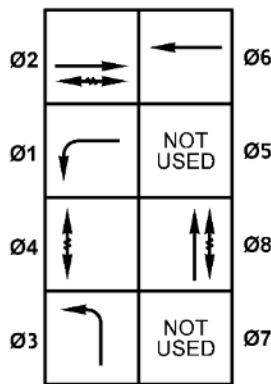

**Six Phase Operation:
Lagging Lefts**
Lagging protected left turns

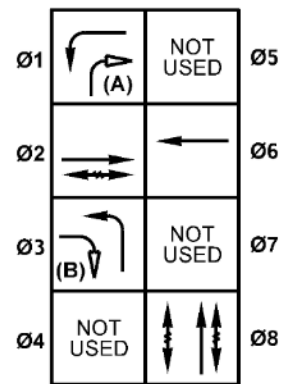

**Six Phase Operation:
Overlaps**
Leading protected left turns with overlapped protected right turns. Right turns may be permissive with associated through phase.

LEGEND

- Protected Vehicle Movement
- Overlap (Protected) Vehicle Movement
- (A) Overlap Phase Letter
- ↔ Protected Pedestrian Movement

If right turns are protected with concurrent through phase, negative pedestrian overlaps must be used.

1330.07(4) Phasing at Railroad Crossings

Traffic signals near railroad crossings have additional special phasing arrangements. To provide for efficient signal operations during a rail crossing, ensure that there are dedicated turn lanes for movements turning onto the tracks. These turn lanes should be on their own dedicated phases, so that they may be omitted from the signal timing (held in red) during the rail crossing. This allows for as many of the other intersection movements as possible to continue to operate – a timing scheme referred to as “Limited Service Operation” (LSO).

Just prior to LSO, when railroad preemption is used, the traffic signal will shift to a “Track Clearance Green” (TCG) phase. TCG shifts non-conflicting phases to green to allow vehicles to clear the railroad tracks. Examples of a TCG phase and LSO are shown in Exhibit 1330-34. Standalone queue cutter signals do not have a TCG phase – contact the HQ Transportation Operations Division for operational guidance on standalone queue cutter signals.

Exhibit 1330-34 Phasing at Railroad Crossings

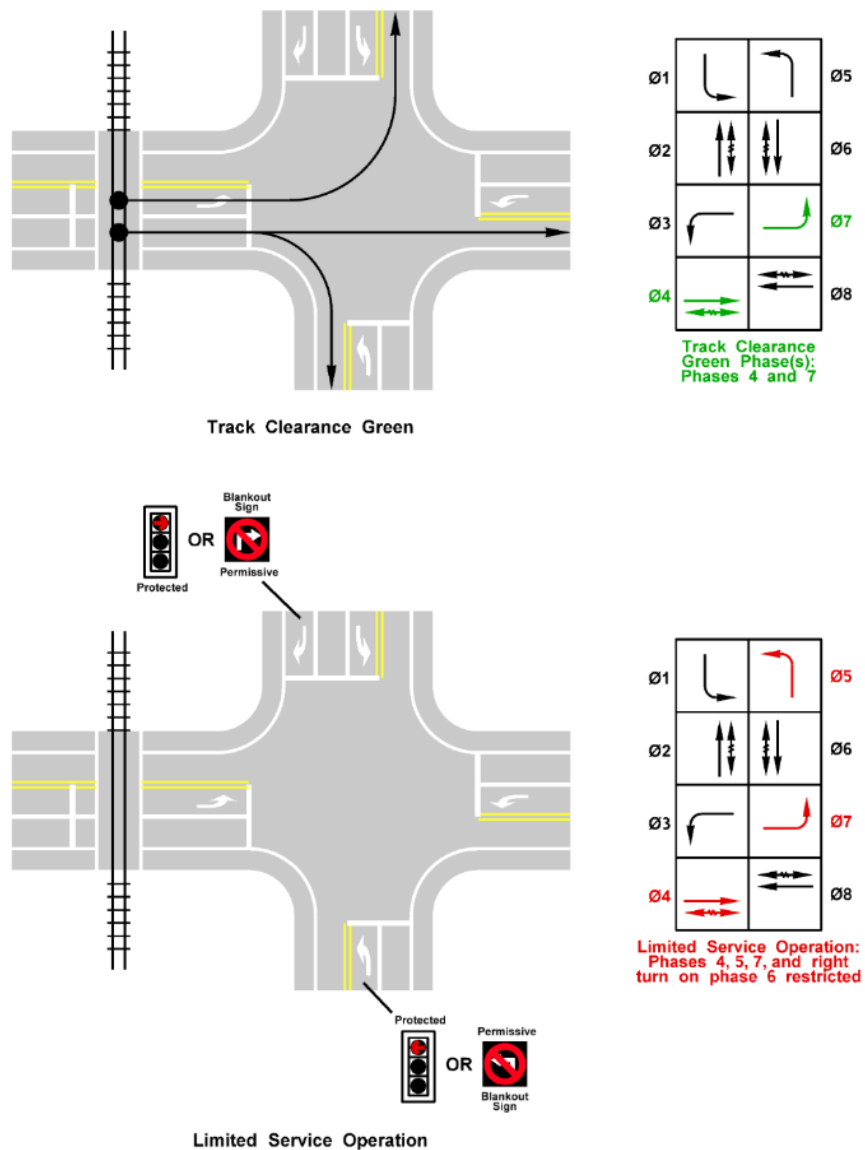

1330.07(5) Accessible Pedestrian Signals

Accessible Pedestrian Signals (APS) are required to be operated as follows:

- All APS at an intersection must use either rapid tick or speech messages – mixed operations at a single intersection are not allowed.
- Street names in speech messages shall be limited to the basic street name. Do not include cardinals (N, S, E, etc.) or street type (street, avenue, road, etc.) unless needed to avoid confusion where two streets have the same name, such as 2nd Avenue and 2nd Street or Center Drive at Center Way.
- Walk messages shall be in the format “Walk sign is on to cross <street>”.
- Button press messages during flashing or solid DON’T WALK phases shall be in the following formats:
 - Short press: “Wait”.
 - Long press: “Wait to cross <street1> at <street2>”. Street names shall use the same format described above.
 - Long press with extended crossing time: “Wait to cross <street1> at <street2> with extended crossing time”.
- Audible countdowns shall not be used. The APS shall default to the locator tone during any phase other than WALK.

1330.08 Documentation

The following original signal design documents shall be included in a Signal System file and provided to the Region Transportation Operations Office or owning agency:

1. Signal Permit, including Signal Warrant Analysis and supporting documentation.
2. FHWA Approval for Experimentation.
3. Signal Standard Design Chart, including signal support engineering calculations.
4. Signal Detection Zone Placement. Include calculations if used.
5. Signal Wiring Diagram and Conduit Fill calculations.
6. Railroad preemption calculation and interconnect setup.
7. Any third-party documentation provided.
8. Approved Preliminary Signal Plan.
9. Emergency Preemption Equipment selected.
10. Transit Priority Preemption and associated agreements.

Copies of items 1 and 2 are also required to be included in the DDP. Copies of items 3 through 10 are also required to be included in the Project File (PF).

Refer to [Chapter 300](#) for additional design documentation requirements.

1330.09 References

The following references are used in the planning, design, construction, and operation of traffic control signals installed on state highways. The RCWs noted are specific state laws concerning traffic control signals, and conformance to these statutes is required.

1330.09(1) Federal/State Laws and Codes

Americans with Disabilities Act of 1990 (ADA) (28 CFR Part 35)

[Revised Code of Washington \(RCW\) 35.77](#), Streets – Planning, establishment, construction, and maintenance

[RCW 46.04.450](#), Railroad sign or signal

[RCW 46.04.600](#), Traffic control signal

[RCW 46.04.62250](#), Signal preemption device

[RCW 46.61.050](#), Obedience to and required traffic control devices

[RCW 46.61.055](#), Traffic control signal legend

[RCW 46.61.060](#), Pedestrian control signals

[RCW 46.61.065](#), Flashing signals

[RCW 46.61.070](#), Lane-direction-control signals

[RCW 46.61.072](#), Special traffic control signals – Legend

[RCW 46.61.075](#), Display of unauthorized signs, signals, or markings

[RCW 46.61.080](#), Interference with official traffic-control devices or railroad signs or signals

[RCW 46.61.085](#), Traffic control signals or devices upon city streets forming part of state highways – Approval by department of transportation

[RCW 46.61.340](#), Approaching train signal

[RCW 47.24.020\(6\)](#) and [\(13\)](#), Jurisdiction, control

[RCW 47.36.020](#), Traffic control signals

[RCW 47.36.025](#), Vehicle-activated traffic control signals – Detection of motorcycles and bicycles

[RCW 47.36.060](#), Traffic devices on county roads and city streets

[Washington Administrative Code \(WAC\) 468 18-040](#), Design standards for rearranged county roads, frontage roads, access roads, intersections, ramps and crossings

[WAC 468-18-050](#), Policy on the construction, improvement and maintenance of intersections of state highways and city streets

“City Streets as Part of State Highways: Guidelines Reached by the Washington State Department of Transportation and the Association of Washington Cities on the Interpretation of Selected Topics of [RCW 47.24](#) and Figures of [WAC 468-18-050](#) for the Construction, Operations and Maintenance Responsibilities of WSDOT and Cities for Such Streets,” April 30, 1997.

[WAC 468-95](#), Manual on Uniform Traffic Control Devices for Streets and Highways (Washington State Supplement)

1330.09(2) Design Guidance

A Policy on the Geometric Design of Highways and City Streets (Green Book), AASHTO

Traffic: Illumination, Traffic Signals and Intelligent Transportation Systems (ITS) | WSDOT (wa.gov)

WSDOT Railroad-Traffic Signal Preemption Timing Worksheet

Manual on Uniform Traffic Control Devices for Streets and Highways, USDOT, FHWA; as adopted and modified by Chapter 468-95 WAC “Manual on uniform traffic control devices for streets and highways” (MUTCD)

Plans Preparation Manual, M 22-31, WSDOT

Revised Draft Guidelines for Accessible Public Rights-of-Way, (PROWAG), November 23, 2005, United States Access Board, <https://www.wsdot.wa.gov/publications/fulltext/design/ADA/PROWAG-2005.pdf>

Standard Plans for Road, Bridge, and Municipal Construction (Standard Plans), M 21 01, WSDOT

Standard Specifications for Road, Bridge, and Municipal Construction (Standard Specifications), M 41-10, WSDOT

WSDOT Traffic Design Resources

<https://wsdot.wa.gov/engineering-standards/design-topics/traffic-illumination-traffic-signals-and-intelligent-transportation-systems-its>

