



Transmittal Number PT 19-007	Date February 2019
Publication Distribution To: <i>Design Manual</i> Holders	
Publication Title <i>Design Manual</i> – February 2019	Publication Number M 22-01.16
Originating Organization WSDOT Development Division, Design Office – Design Policy, Standards, and Safety Research Section	

Remarks and Instructions

What's changed in the Design Manual for February 2019?

How do you stay connected to current design policy?

It's the designer's responsibility to apply current design policy when developing transportation projects at WSDOT. The best way to know what's current is to reference the manual online.

Access the current electronic WSDOT *Design Manual*, the latest revision package, and individual chapters at: www.wsdot.wa.gov/publications/manuals/m22-01.htm

We're ready to help. If you have comments or questions about the Design Manual, please don't hesitate to contact us.

Area of Practice	Your Contacts
General Guidance and Support	John Tevis 360-705-7460 TEVISJ@wsdot.wa.gov

To get the latest information on individual WSDOT publications:

Sign up for email updates at: www.wsdot.wa.gov/publications/manuals/

HQ Design Office Signature /s/ Mike Fleming	Phone Number 360-705-7233
---	------------------------------

Remove/Insert instructions for those who maintain a printed manual

CHAPTER/SECTION	REMOVE PAGES	INSERT PAGES
Title Page	All pages	All pages
Contents/Exhibits	Page 1 - 26	Page 1 - 26
300 Design Documentation, Approval, and Process Review	Entire chapter	Entire chapter
540 Managed Access Control	Entire chapter	Entire chapter
1105 Design Element Selection	Entire chapter	Entire chapter
1120 Preservation Projects	Entire chapter	Entire chapter
1320 Roundabouts	Entire chapter	1320-1 – 1320-28
1600 Roadside Safety	Entire chapter	Entire chapter
1610 Traffic Barriers	Entire chapter	Entire chapter
1620 Impact Attenuator Systems	Entire chapter	Entire chapter

About revision marks and footer dates:

- A new date appears in the footer of each page that has changes.
- Changes include inserted or deleted content and existing content that shifts to a new page.
- Substantially rewritten chapters will have no revision marks. This is the case with many chapters this publication.
- In some cases, just a page of a chapter changed with a spot revision, such as a correction or new chapter reference.



Design Manual

M 22-01.16

February 2019

- Division 1 – General Information
- Division 2 – Hearings, Environmental, and Permits
- Division 3 – Project Documentation
- Division 4 – Surveying
- Division 5 – Right of Way and Access Control
- Division 6 – Soils and Paving
- Division 7 – Structures
- Division 8 – Hydraulics
- Division 9 – Roadside Development
- Division 10 – Traffic Safety Elements
- Division 11 – Practical Design
- Division 12 – Geometrics
- Division 13 – Intersections and Interchanges
- Division 14 – HOV and Transit
- Division 15 – Pedestrian and Bicycle Facilities
- Division 16 – Roadside Safety Elements
- Division 17 – Roadside Facilities

Engineering and Regional Operations

Development Division, Design Office

Americans with Disabilities Act (ADA) Information

Materials can be made available in an alternative format by emailing the WSDOT Diversity/ADA Affairs Team at wsdotada@wsdot.wa.gov or by calling toll free: 855-362-4ADA (4232). Persons who are deaf or hard of hearing may contact that number via the Washington Relay Service at 7-1-1.

Title VI Notice to Public

It is Washington State Department of Transportation (WSDOT) policy to ensure no person shall, on the grounds of race, color, national origin, or sex, as provided by Title VI of the Civil Rights Act of 1964, be excluded from participation in, be denied the benefits of, or be otherwise discriminated against under any of its federally funded programs and activities. Any person who believes his/her Title VI protection has been violated may file a complaint with WSDOT's Office of Equal Opportunity (OEO). For Title VI complaint forms and advice, please contact OEO's Title VI Coordinator at 360-705-7082 or 509-324-6018.

To get the latest information on individual WSDOT publications, sign up for email updates at:

 www.wsdot.wa.gov/publications/manuals

Division 1 – General Information

- Chapter 100 Manual Description**
- 100.01 Purpose
 - 100.02 Presentation and Revisions
 - 100.03 Practical Solutions
 - 100.04 Manual Applications
 - 100.05 Manual Use
 - 100.06 Manual Organization
- Chapter 110 Design-Build Projects**
- 110.01 General
 - 110.02 Terminology and Language Used
 - 110.03 Design and Documentation Responsibility
 - 110.04 References

Division 2 – Hearings, Environmental, and Permits

- Chapter 210 Public Involvement and Hearings**
- 210.01 General
 - 210.02 References
 - 210.03 Definitions
 - 210.04 Public Involvement
 - 210.05 Public Hearings
 - 210.06 Environmental Hearing
 - 210.07 Corridor Hearing
 - 210.08 Design Hearing
 - 210.09 Limited Access Hearing
 - 210.10 Combined Hearings
 - 210.11 Administrative Appeal Hearing
 - 210.12 Follow-Up Hearing
 - 210.13 Documentation
- Chapter 225 Environmental Coordination**
- 225.01 General
 - 225.02 References
 - 225.03 Determining the Environmental Documentation
 - 225.04 Identifying the Project Classification
 - 225.05 Environmental Commitment File
 - 225.06 Environmental Permits and Approvals
 - 225.07 Documentation

Division 3 – Project Documentation

- Chapter 300 Design Documentation, Approval, and Process Review**
- 300.01 General
 - 300.02 WSDOT Project Delivery
 - 300.03 Design Documentation and Records Retention Policy
 - 300.04 Project Design Approvals
 - 300.05 FHWA Oversight and Approvals
 - 300.06 Project Documents and Approvals
 - 300.07 Process Review
 - 300.08 References

Chapter 301	Design and Maintenance Coordination
301.01	Introduction
301.02	Communication
301.03	Incorporating Maintenance Considerations in Design
301.04	Documentation
301.05	References
Chapter 305	Project Management
305.01	Introduction
305.02	Project Management
305.03	Project Management Tools
305.04	Cost and Risk Management
305.05	References
Chapter 310	Value Engineering
310.01	General
310.02	Statewide VE Program
310.03	VE Procedure
310.04	Value Engineering Job Plan
310.05	Project Management Accountability
310.06	Documentation
310.07	References
Chapter 320	Traffic Analysis
320.01	General
320.02	Design Year and Forecasting Considerations
320.03	Traffic Analysis Software
320.04	Travel Demand Forecasting
320.05	Traffic Impact Analysis (TIA)
320.06	TIA Scope
320.07	TIA Methods and Assumptions Document
320.08	TIA Methodologies
320.09	TIA Mitigation Measures
320.10	TIA Report
320.11	References
Chapter 321	Sustainable Safety Analysis
321.01	Sustainable Safety Related Policy
321.02	HQ Safety Technical Group
321.03	Project Related Safety Analysis
321.04	Stand Alone Safety Analysis
321.05	Reports and Documentation
321.06	References

Division 4 – Surveying

Chapter 400	Surveying and Mapping
400.01	General
400.02	References
400.03	Procedures
400.04	Datums
400.05	Global Positioning System
400.06	WSDOT Survey Monument Database
400.07	Geographic Information System
400.08	Photogrammetric Surveys
400.09	Documentation

Chapter 410 Monumentation

- 410.01 General
- 410.02 References
- 410.03 Control Monuments
- 410.04 Alignment Monuments
- 410.05 Property Corners
- 410.06 Other Monuments
- 410.07 Filing Requirements
- 410.08 Documentation

Division 5 – Right of Way and Access Control

Chapter 510 Right of Way Considerations

- 510.01 General
- 510.02 Special Features
- 510.03 Easements and Permits
- 510.04 Programming for Funds
- 510.05 Appraisal and Acquisition
- 510.06 Transactions
- 510.07 Documentation
- 510.08 References

Chapter 520 Access Control

- 520.01 General
- 520.02 References
- 520.03 Definitions
- 520.04 Vocabulary

Chapter 530 Limited Access Control

- 530.01 General
- 530.02 Achieving Limited Access
- 530.03 Full Control (Most Restrictive)
- 530.04 Partial Control
- 530.05 Modified Control (Least Restrictive)
- 530.06 Access Approaches
- 530.07 Frontage Roads
- 530.08 Turnbacks
- 530.09 Adjacent Railroads
- 530.10 Access Breaks and Inner Corridor Access
- 530.11 Documentation

Chapter 540 Managed Access Control

- 540.01 General
- 540.02 Design Considerations
- 540.03 Managed Access Highway Classes
- 540.04 Corner Clearance Criteria
- 540.05 Access Connection Categories
- 540.06 Access Connection Permit
- 540.07 Permitting and Design Documentation
- 540.08 Other Considerations
- 540.09 Preconstruction Conference
- 540.10 Adjudicative Proceedings
- 540.11 Documentation
- 540.12 References

Chapter 550 Freeway Access Revision
550.01 Overview
550.02 Freeway Access Policy
550.03 Access Revision Analysis Process
550.04 Support Teams
550.05 Non-Access Feasibility Study
550.06 Access Revision Report Process
550.07 Documentation
550.08 References

Chapter 560 Fencing
560.01 General
560.02 Design Criteria
560.03 Fencing Types
560.04 Gates
560.05 Procedure
560.06 Documentation
560.07 References

Division 6 – Soils and Paving

Chapter 610 Investigation of Soils, Rock, and Surfacing Materials
610.01 General
610.02 References
610.03 Materials Sources
610.04 Geotechnical Investigation, Design, and Reporting
610.05 Use of Geotechnical Consultants
610.06 Geotechnical Work by Others
610.07 Surfacing Report
610.08 Documentation

Chapter 620 Design of Pavement Structure
620.01 General
620.02 Estimating Tables

Chapter 630 Geosynthetics
630.01 General
630.02 References
630.03 Geosynthetic Types and Characteristics
630.04 Geosynthetic Function Definitions and Applications
630.05 Design Approach for Geosynthetics
630.06 Design Responsibility
630.07 Documentation

Division 7 – Structures

Chapter 700 Project Development Roles and Responsibilities for Projects With Structures
700.01 General
700.02 Procedures

Chapter 710 Site Data for Structures
710.01 General
710.02 Required Data for All Structures
710.03 Additional Data for Waterway Crossings (Bridges and Buried Structures)
710.04 Additional Data for Grade Separations

- 710.05 Additional Data for Widening
- 710.06 Documentation
- 710.07 References

Chapter 720 Bridges

- 720.01 General
- 720.02 Bridge Locations
- 720.03 Bridge Site Design Elements
- 720.04 Documentation
- 720.05 References

Chapter 730 Retaining Walls and Steep Reinforced Slopes

- 730.01 General
- 730.02 References
- 730.03 Design Principles
- 730.04 Design Requirements
- 730.05 Guidelines for Wall/Slope Selection
- 730.06 Design Responsibility and Process
- 730.07 Documentation

Chapter 740 Noise Barriers

- 740.01 General
- 740.02 Design
- 740.03 Procedures
- 740.04 Documentation
- 740.05 References

Division 8 – Hydraulics

Chapter 800 Hydraulic Design

- 800.01 General
- 800.02 References
- 800.03 Hydraulic Considerations
- 800.04 Safety Considerations
- 800.05 Design Responsibility
- 800.06 Documentation

Division 9 – Roadside Development

Chapter 900 Roadsides

- 900.01 General
- 900.02 References
- 900.03 Project Development
- 900.04 Documentation

Chapter 950 Public Art

- 950.01 General
- 950.02 References
- 950.03 Standard Architectural Design
- 950.04 Criteria for Public Art
- 950.05 Process and Project Delivery Timing
- 950.06 Approvals
- 950.07 Documentation

Division 10 – Traffic Safety Elements

Chapter 1010 Work Zone Safety and Mobility

- 1010.01 General
- 1010.02 Definitions
- 1010.03 Work Zone Safety and Mobility
- 1010.04 Transportation Management Plans and Significant Projects
- 1010.05 Developing TMP Strategies
- 1010.06 Capacity Analysis
- 1010.07 Work Zone Design
- 1010.08 Temporary Traffic Control Devices
- 1010.09 Positive Protection Devices
- 1010.10 Other Traffic Control Devices or Features
- 1010.11 Traffic Control Plan Development and PS&E
- 1010.12 Training and Resources
- 1010.13 Documentation
- 1010.14 References

Chapter 1020 Signing

- 1020.01 General
- 1020.02 Design Components
- 1020.03 Overhead Installation
- 1020.04 State Highway Route Numbers
- 1020.05 Mileposts
- 1020.06 Guide Sign Plan
- 1020.07 Documentation
- 1020.08 References

Chapter 1030 Delineation

- 1030.01 General
- 1030.02 Definitions
- 1030.03 Pavement Markings
- 1030.04 Guideposts
- 1030.05 Barrier Delineation
- 1030.06 Object Markers
- 1030.07 Documentation
- 1030.08 References

Chapter 1040 Illumination

- 1040.01 General
- 1040.02 Definitions
- 1040.03 Design Considerations
- 1040.04 Required Illumination
- 1040.05 Additional Illumination
- 1040.06 Design Criteria
- 1040.07 Documentation
- 1040.08 References

Chapter 1050 Intelligent Transportation Systems

- 1050.01 General
- 1050.02 References
- 1050.03 Systems Engineering
- 1050.04 FHWA Washington Division ITS Project Contracting Guidance
- 1050.05 Documentation

Division 11 – Practical Design

Chapter 1100 Practical Design

- 1100.01 General
- 1100.02 Practical Design Procedure
- 1100.03 Community Engagement
- 1100.04 Advisory Team
- 1100.05 Need and Performance Identification
- 1100.06 Context Identification
- 1100.07 Design Control Selection
- 1100.08 Alternative Formulation and Evaluation
- 1100.09 Design Element Selection and Dimensions
- 1100.10 Documentation Tools
- 1100.11 References

Chapter 1101 Need Identification

- 1101.01 General
- 1101.02 Baseline Needs
- 1101.03 Contextual Needs
- 1101.04 Contributing Factors Analysis
- 1101.05 Project Need Statement
- 1101.06 Documentation
- 1101.07 References

Chapter 1102 Context Determination

- 1102.01 General Overview
- 1102.02 Land Use Context
- 1102.03 Transportation Context
- 1102.04 Documentation
- 1102.05 References

Chapter 1103 Design Control Selection

- 1103.01 General Overview
- 1103.02 Control: Design Year
- 1103.03 Control: Modal Priority
- 1103.04 Control: Access Control
- 1103.05 Control: Design Speed
- 1103.06 Control: Terrain Classification
- 1103.07 Documentation
- 1103.08 References

Chapter 1104 Alternatives Analysis

- 1104.01 General
- 1104.02 Alternative Solution Formulation
- 1104.03 Alternative Solution Evaluation
- 1104.04 Documentation
- 1104.05 References

Chapter 1105 Design Element Selection

- 1105.01 General
- 1105.02 Selecting Design Elements
- 1105.03 Related Elements
- 1105.04 Documentation
- 1105.05 References

Chapter 1106 Design Element Dimensions

- 1106.01 General
- 1106.02 Choosing Dimensions
- 1106.03 The Mode/Function/Performance Approach
- 1106.04 Design Up Method
- 1106.05 Quantitative Analysis Methods and Tools
- 1106.06 Documenting Dimensions
- 1106.07 Design Analysis
- 1106.08 References

Chapter 1120 Preservation Projects

- 1120.01 General
- 1120.02 Structures Preservation (P2) and Other Facilities (P3)
- 1120.03 Roadway Preservation (P1)

Division 12 – Geometrics

Chapter 1210 Geometric Plan Elements

- 1210.01 General
- 1210.02 Horizontal Alignment
- 1210.03 Distribution Facilities
- 1210.04 Number of Lanes and Arrangement
- 1210.05 Pavement Transitions
- 1210.06 Procedures
- 1210.07 Documentation
- 1210.08 References

Chapter 1220 Geometric Profile Elements

- 1220.01 General
- 1220.02 Vertical Alignment
- 1220.03 Coordination of Vertical and Horizontal Alignments
- 1220.04 Airport Clearance
- 1220.05 Railroad Crossings
- 1220.06 Procedures
- 1220.07 Documentation
- 1220.08 References

Chapter 1230 Geometric Cross Section Basics

- 1230.01 General
- 1230.02 Guidance for Specific Facility Types
- 1230.03 Common Elements
- 1230.04 Jurisdiction for Design and Maintenance
- 1230.05 References

Chapter 1231 Geometric Cross Section – Highways

- 1231.01 General
- 1231.02 Design Up
- 1231.03 Common Elements
- 1231.04 Vehicle Lanes
- 1231.05 Modally Integrated Cross Sections
- 1231.06 Road Diets and Retrofit Options
- 1231.07 References

Chapter 1232 Geometric Cross Section – Freeways

- 1232.01 General
- 1232.02 Lane Width

	1232.03	Shoulder Width
	1232.04	Other Elements
	1232.05	Design Flexibility
	1232.06	References
Chapter 1238	Geometric Cross Section – Streetside and Parking	
	1238.01	General
	1238.02	Parking
	1238.03	Streetside
	1238.04	Retrofit Options
	1238.05	References
Chapter 1239	Geometric Cross Section – Shoulders, Side Slopes, Curbs, and Medians	
	1239.01	Introduction
	1239.02	Shoulders
	1239.03	Side Slopes and Ditches
	1239.04	Roadway Sections in Rock Cuts
	1239.05	Curbs
	1239.06	Lateral Clearance to Curb and Barrier
	1239.07	Medians & Outer Separations
Chapter 1240	Turning Roadways	
	1240.01	General
	1240.02	Turning Roadway Widths
	1240.03	Documentation
	1240.04	References
Chapter 1250	Cross slope and Superelevation	
	1250.01	General
	1250.02	Roadway Cross Slope
	1250.03	Superelevation Rate Selection
	1250.04	Existing Curves
	1250.05	Turning Movements at Intersections
	1250.06	Runoff for Highway Curves
	1250.07	Runoff for Ramp Curves
	1250.08	Documentation
	1250.09	References
Chapter 1260	Sight Distance	
	1260.01	General
	1260.02	References
	1260.03	Stopping Sight Distance
	1260.04	Passing Sight Distance
	1260.05	Decision Sight Distance
	1260.06	Documentation
Chapter 1270	Auxiliary Lanes	
	1270.01	General
	1270.02	Climbing Lanes
	1270.03	Passing Lanes
	1270.04	Slow-Moving Vehicle Turnouts
	1270.05	Shoulder Driving for Slow Vehicles
	1270.06	Emergency Escape Ramps
	1270.07	Chain-Up and Chain-Off Areas
	1270.08	Documentation
	1270.09	References

Division 13 – Intersections and Interchanges

Chapter 1300 Intersection Control Type

- 1300.01 General
- 1300.02 Intersection Control Objectives
- 1300.03 Common Types of Intersection Control
- 1300.04 Modal Considerations
- 1300.05 Procedures
- 1300.06 Documentation
- 1300.07 References

Chapter 1310 Intersections

- 1310.01 General
- 1310.02 Design Considerations
- 1310.03 Design Elements
- 1310.04 U-Turns
- 1310.05 Intersection Sight Distance
- 1310.06 Signing and Delineation
- 1310.07 Procedures
- 1310.08 Documentation
- 1310.09 References

Chapter 1320 Roundabouts

- 1320.01 General
- 1320.02 Roundabout Types
- 1320.03 Capacity Analysis
- 1320.04 Geometric Design
- 1320.05 Pedestrians
- 1320.06 Bicycles
- 1320.07 Signing
- 1320.08 Pavement Marking
- 1320.09 Illumination
- 1320.10 Road Approach, Parking, and Transit Facilities
- 1320.11 Geometric Design Peer Review
- 1320.12 Documentation and Approvals
- 1320.13 References

Chapter 1330 Traffic Control Signals

- 1330.01 General
- 1330.02 Procedures
- 1330.03 Intersection Design Considerations
- 1330.04 Conventional Traffic Signal Design
- 1330.05 Preliminary Signal Plan
- 1330.06 Operational Considerations for Design
- 1330.07 Documentation
- 1330.08 References

Chapter 1340 Driveways

- 1340.01 General
- 1340.02 References
- 1340.03 Design Considerations
- 1340.04 Driveway Design Templates
- 1340.05 Sidewalks
- 1340.06 Driveway Sight Distance
- 1340.07 Stormwater and Drainage
- 1340.08 Mailboxes
- 1340.09 Documentation

Chapter 1350 Railroad Grade Crossings

- 1350.01 General
- 1350.02 References
- 1350.03 Plans
- 1350.04 Traffic Control Systems
- 1350.05 Nearby Roadway Intersections
- 1350.06 Pullout Lanes
- 1350.07 Crossing Surfaces
- 1350.08 Crossing Closure
- 1350.09 Traffic Control During Construction and Maintenance
- 1350.10 Railroad Grade Crossing Petitions and WUTC Orders
- 1350.11 Grade Crossing Improvement Projects
- 1350.12 Light Rail
- 1350.13 Documentation

Chapter 1360 Interchanges

- 1360.01 General
- 1360.02 Interchange Design
- 1360.03 Ramps
- 1360.04 Interchange Connections
- 1360.05 Ramp Terminal Intersections at Crossroads
- 1360.06 Interchanges on Two-Lane Highways
- 1360.07 Interchange Plans for Approval
- 1360.08 Documentation
- 1360.09 References

Chapter 1370 Median Crossovers

- 1370.01 General
- 1370.02 Analysis
- 1370.03 Design
- 1370.04 Plan Updates and Approvals
- 1370.05 Documentation

Division 14 – HOV and Transit

Chapter 1410 High-Occupancy Vehicle Facilities

- 1410.01 General
- 1410.02 Preliminary Design and Planning
- 1410.03 Operations
- 1410.04 Design Criteria
- 1410.05 Documentation
- 1410.06 References

Chapter 1420 HOV Direct Access

- 1420.01 General
- 1420.02 HOV Access Types and Locations
- 1420.03 Direct Access Geometrics
- 1420.04 Passenger Access
- 1420.05 Traffic Design Elements
- 1420.06 Documentation
- 1420.07 References

Chapter 1430 Transit Facilities

- 1430.01 General
- 1430.02 Bus Stops and Pullouts
- 1430.03 Passenger Amenities

1430.04	Park and Ride Lots
1430.05	Transfer/Transit Centers
1430.06	Roadway and Intersection Design
1430.07	Documentation
1430.08	References

Division 15 – Pedestrian and Bicycle Facilities

Chapter 1510 Pedestrian Facilities

1510.01	General
1510.02	References
1510.03	Definitions
1510.04	Policy
1510.05	ADA Requirements by Project Type
1510.06	Pedestrian Circulation Paths
1510.07	Pedestrian Access Routes (PARs)
1510.08	Sidewalks
1510.09	Curb Ramps
1510.10	Crosswalks
1510.11	Raised Medians/Traffic Islands
1510.12	Pedestrian Pushbuttons
1510.13	At-Grade Railroad Crossings
1510.14	Pedestrian Grade Separations (Structures)
1510.15	Other Pedestrian Facilities
1510.16	Illumination and Signing
1510.17	Work Zone Pedestrian Accommodation
1510.18	Documentation

Chapter 1515 Shared-Use Paths

1515.01	General
1515.02	References
1515.03	Definitions
1515.04	Shared-Use Path Design – The Basics
1515.05	Intersections and Crossings Design
1515.06	Grade Separation Structures
1515.07	Signing, Pavement Markings, and Illumination
1515.08	Restricted Use Controls
1515.09	Documentation

Chapter 1520 Roadway Bicycle Facilities

1520.01	General
1520.02	Roadway Bicycle Facility Types
1520.03	Bicycle Facility Selection
1520.04	Intersection Design Treatments
1520.05	Additional Bicycle Design Requirements and Considerations
1520.06	Documentation
1520.07	References

Division 16 – Roadside Safety Elements

Chapter 1600 Roadside Safety

1600.01	General
1600.02	Clear Zone
1600.03	Mitigation Guidance
1600.04	Medians
1600.05	Other Roadside Safety Features

- 1600.06 Documentation
- 1600.07 References

Chapter 1610 Traffic Barriers

- 1610.01 Introduction
- 1610.02 Barrier Impacts
- 1610.03 General Barrier Design Considerations
- 1610.04 Beam Guardrail
- 1610.05 High-Tension Cable Barrier
- 1610.06 Concrete Barrier
- 1610.07 Bridge Traffic Barriers
- 1610.08 Other Barriers
- 1610.09 References

Chapter 1620 Impact Attenuator Systems

- 1620.01 General
- 1620.02 Design Criteria
- 1620.03 Selection Considerations
- 1620.04 Transportable Attenuators (Truck-Mounted and Trailer-Mounted)
- 1620.05 Older Systems
- 1620.06 Inertial Barrier Systems (Sand Barrels)

Division 17 – Roadside Facilities

Chapter 1710 Safety Rest Areas and Traveler Services

- 1710.01 General
- 1710.02 References
- 1710.03 Definitions
- 1710.04 Safety Rest Area Project Team
- 1710.05 Location, Access, and Site Design
- 1710.06 Buildings
- 1710.07 Utilities
- 1710.08 Documentation

Chapter 1720 Weigh Sites

- 1720.01 General
- 1720.02 Definitions
- 1720.03 Planning, Development, and Responsibilities
- 1720.04 Permanent Facilities
- 1720.05 Portable Facilities
- 1720.06 Shoulder Sites
- 1720.07 Federal Participation
- 1720.08 Procedures
- 1720.09 Documentation

Glossary

110-1	Design Documentation Sequence for a Typical Design-Build Project
210-1	Types of Public Hearings
210-2	Public Hearing Formats
210-3	Prehearing Packet Checklist
210-4	Sequence for Corridor, Design, and Environmental Hearings
210-5	Sequence for Limited Access Hearing
210-6	Hearing Summary Approvals
300-1	Approval Authorities
300-2	Approvals
300-3	PS&E Process Approvals NHS (Including Interstate) and Non-NHS
300-4	Design to Construction Transition Project Turnover Checklist Example
301-1	General Input Form with Listed Performance Objectives
301-2	Design Option Worksheet Showing Example of Life Cycle Cost Assessment
301-3	Excerpts from Olympic Region Review Checklist
305-1	WSDOT Project Management Process
310-1	Seven-Phase Job Plan for VE Studies
310-2	VE Analysis Team Tools
310-3	Value Engineering Job Plan
400-1	Interagency Agreement
400-2	Report of Survey Mark Example
410-1	Monument Documentation Summary
410-2	DNR Permit Application
410-3	DNR Completion Report Form
410-4	Land Corner Record
510-1	Appraisal and Acquisition
520-1	Access Control Vocabulary
530-1a	Full Access Control Limits: Interchange
530-1b	Full Access Control Limits: Interchange
530-1c	Full Access Control Limits: Interchange With Roundabouts
530-1d	Full Access Control Limits: Ramp Terminal With Transition Taper
530-1e	Full Access Control Limits: Single Point Urban Interchange
530-1f	Full Access Control Limits: Diverging Diamond Interchange
530-2a	Partial Access Control Limits: At-Grade Intersections
530-2b	Partial Access Control Limits: Roundabout Intersections
530-3a	Modified Access Control Limits: Roundabout Intersections
530-3b	Modified Access Control Limits: Intersections

540-1	Managed Access Highway Class Description
540-2	Minimum Corner Clearance: Distance From Access Connection to Public Road or Street
550-1	Non-Access Feasibility Study Process
550-2	Access Revision Report Process
550-3	Access Revision Report: Stamped Cover Sheet Example
550-4	Access Revision Documentation and Review/Approval Levels
610-1	Materials Source Development
620-1	Estimating: Miscellaneous Tables
620-2	Estimating: Hot Mix Asphalt Pavement and Asphalt Distribution Tables
620-3	Estimating: Bituminous Surface Treatment
620-4	Estimating: Base and Surfacing Typical Section Formulae and Example
620-5a	Estimating: Base and Surfacing Quantities
620-5b	Estimating: Base and Surfacing Quantities
620-5c	Estimating: Base and Surfacing Quantities
620-5d	Estimating: Base and Surfacing Quantities
620-5e	Estimating: Base and Surfacing Quantities
620-5f	Estimating: Base and Surfacing Quantities
620-5g	Estimating: Base and Surfacing Quantities
620-5h	Estimating: Base and Surfacing Quantities
630-1	Selection Criteria for Geotextile Class
630-2	Maximum Sheet Flow Lengths for Silt Fences
630-3	Maximum Contributing Area for Ditch and Swale Applications
630-4	Design Process for Drainage and Erosion Control: Geotextiles and Nonstandard Applications
630-5	Design Process for Separation, Soil Stabilization, and Silt Fence
630-6	Examples of Various Geosynthetics
630-7	Geotextile Application Examples
630-8	Definition of Slope Length
630-9	Definition of Ditch or Swale Storage Length and Width
630-10	Silt Fences for Large Contributing Area
630-11	Silt Fence End Treatment
630-12	Gravel Check Dams for Silt Fences
700-1	Determination of the Roles and Responsibilities for Projects With Structures: Project Development Phase
710-1	Structure Site Data Checklist
720-1	Phased Development of Multilane Divided Highways
720-2	Highway Structure Over Railroad
720-3	Bridge Vertical Clearances
720-4	Embankment Slope at Bridge Ends
730-1	Summary of Mechanically Stabilized Earth (MSE) Gravity Wall/Slope Options Available

Exhibits

730-2	Summary of Prefabricated Modular Gravity Wall Options Available
730-3	Summary of Rigid Gravity and Semigravity Wall Options Available
730-4	Summary of Nongravity Wall Options Available
730-5	Summary of Anchored Wall Options Available
730-6	Other Wall/Slope Options Available
730-7	Typical Mechanically Stabilized Earth Gravity Walls
730-8	Typical Prefabricated Modular Gravity Walls
730-9	Typical Rigid Gravity, Semigravity Cantilever, Nongravity Cantilever, and Anchored Walls
730-10	Typical Rockery and Reinforced Slopes
730-11	MSE Wall Drainage Detail
730-12	Retaining Walls With Traffic Barriers
730-13a	Retaining Wall Design Process
730-13b	Retaining Wall Design Process: Proprietary
740-1	Standard Noise Wall Types
1010-1	General Lane Closure Work Zone Capacity
1010-2	Minimum Work Zone Clear Zone Distance
1010-3	Transportation Management Plan Components Checklist
1020-1	Reflective Sheeting Requirements for Overhead Signs
1020-2	Timber Posts
1020-3	Wide Flange Steel Posts
1020-4	Laminated Wood Box Posts
1030-1	Pavement Marking Material Guide – Consult Region Striping Policy
1030-2	Guidepost Placement
1040-1a	Freeway Lighting Applications
1040-1b	Freeway Lighting Applications
1040-1c	Freeway Lighting Applications
1040-2	Freeway Ramp Terminals
1040-3	Ramp With Meter
1040-4a	HOT (High-Occupancy Toll) Lane Enter/Exit Zone
1040-4b	HOT (High-Occupancy Toll) Lane Access Weave Lane
1040-5	Lane Reduction
1040-6a	Intersection With Left-Turn Channelization: Divided Highway
1040-6b	Intersections With Left-Turn Channelization
1040-6c	Intersections With Raised Left-Turn Channelization
1040-7	Intersections With Traffic Signals
1040-8	Intersection Without Channelization
1040-9	Roundabout
1040-10	Railroad Crossing With Gates or Signals
1040-11	Midblock Pedestrian Crossing

1040-12	Transit Flyer Stop
1040-13	Major Parking Lot
1040-14	Minor Parking Lot
1040-15	Truck Weigh Site
1040-16	Safety Rest Area
1040-17	Chain-Up/Chain-Off Parking Area
1040-18	Bridge Inspection Lighting System
1040-19	Traffic Split Around an Obstruction
1040-20	Construction Work Zone and Detour
1040-21	Diverging Diamond Interchange
1040-22	Light Levels and Uniformity Ratios
1050-1	Systems Engineering Process (“V” Diagram)
1050-2	Intelligent Transportation Systems (ITS) Systems Engineering Analysis Worksheet
1050-3	FHWA Washington Division – ITS Project Contracting Guidance
1100-1	Basis of Design Flowchart
1102-1	Factors for Determining Initial Land Use Context
1103-1	WSDOT Design Controls
1103-2	Initial Modal Accommodation Level
1103-3	Example Characteristics Related to Modal Accomodation
1103-4	Target Speed Based on Land Use Context and Roadway Type
1103-5	Speed Transition Segment Example
1103-6	Geometric Traffic Calming Treatments and Considerations
1103-7	Roadside, Streetside, and Pavement-Oriented Traffic Calming Treatments
1105-1	Required Design Elements
1106-1	Dimensioning Guidance Variations
1106-2	Mode/Function/Performance Approach
1210-1	Maximum Angle Without Curve
1210-2a	Alignment Examples
1210-2b	Alignment Examples
1210-2c	Alignment Examples
1220-1	Grade Length
1220-2a	Coordination of Horizontal and Vertical Alignments
1220-2b	Coordination of Horizontal and Vertical Alignments
1220-2c	Coordination of Horizontal and Vertical Alignments
1220-3	Grading at Railroad Crossings
1230-1	Geometric Cross Section - Guide to Chapters
1230-2	State and City Jurisdictional Responsibilities
1231-1	Lane Widths for Highways
1231-2	Lane Width Considerations

1231-3	Motor Vehicle Oriented Cross Sections
1231-4	Cross Sections Featuring Bicycle Facilities
1231-5	Cross Sections Featuring Pedestrian Facilities
1231-6	Cross Sections Featuring Transit Facilities
1231-7	Complete Street Cross Sections
1232-1	Geometric Cross Section - Interstate (4 lanes shown, can vary)
1232-2	Geometric Cross Section – Non-Interstate (4 lanes shown, can vary)
1232-3	Median Section without Median Barrier
1238-1	Zones within the Streetside
1239-1	Shoulder Widths for Highways
1239-2	Shoulder Function & Modal Accommodation Width Considerations
1239-3	Shoulder Details
1239-3	Shoulder Details (continued)
1239-4	Drainage Ditch Details
1239-5a	Bridge End Slopes
1239-5b	Bridge End Slope Details
1239-6	Roadway Sections in Rock Cuts: Design A
1239-7	Roadway Sections in Rock Cuts: Design B
1239-8	Stepped Slope Design
1239-9	Minimum Lateral Clearance to Barrier and Curb
1239-10	Median Functions and Guidance: High and Intermediate Speeds
1239-11	Median Functions and Guidance: Low and Intermediate Speeds
1239-12a	Divided Highway Median Sections
1239-12b	Divided Highway Median Sections
1239-12c	Divided Highway Median Sections
1240-1a	Traveled Way Width for Two-Lane Two-Way Turning Roadways
1240-1b	Traveled Way Width for Two-Lane Two-Way Turning Roadways: Based on the Delta Angle
1240-2a	Traveled Way Width for Two-Lane One-Way Turning Roadways
1240-2b	Traveled Way Width for Two-Lane One-Way Turning Roadways: Based on the Delta Angle
1240-3a	Traveled Way Width for One-Lane Turning Roadways
1240-3b	Traveled Way Width for One-Lane Turning Roadways: Based on the Delta Angle, Radius on Outside Edge of Traveled Way
1240-3c	Traveled Way Width for One-Lane Turning Roadways: Based on the Delta Angle, Radius on Inside Edge of Traveled Way
1250-1	Minimum Radius for Normal Crown Section
1250-2	Minimum Radius for Existing Curves
1250-3	Side Friction Factor
1250-4a	Superelevation Rates (10% Max)

1250-4b	Superelevation Rates (8% Max)
1250-4c	Superelevation Rates (6% Max)
1250-5	Superelevation Rates for Intersections and Low-Speed Urban Roadways
1250-6a	Superelevation Transitions for Highway Curves
1250-6b	Superelevation Transitions for Highway Curves
1250-6c	Superelevation Transitions for Highway Curves
1250-6d	Superelevation Transitions for Highway Curves
1250-6e	Superelevation Transitions for Highway Curves
1250-7a	Superelevation Transitions for Ramp Curves
1250-7b	Superelevation Transitions for Ramp Curves
1260-1	Design Stopping Sight Distance
1260-2	Design Stopping Sight Distance on Grades
1260-3	Stopping Sight Distance on Grades
1260-4	Stopping Sight Distance: Crest Vertical Curves
1260-5	Sight Distance: Crest Vertical Curve
1260-6	Stopping Sight Distance for Sag Vertical Curves
1260-7	Sight Distance: Sag Vertical Curve
1260-8	Horizontal Stopping Sight Distance
1260-9	Sight Distance: Horizontal Curves
1260-10	Sight Distance: Overlapping Horizontal and Crest Vertical Curves
1260-11	Existing Stopping Sight Distance
1260-12	Passing Sight Distance
1260-13	Passing Sight Distance: Crest Vertical Curve Calculations
1260-14	Passing Sight Distance: Crest Vertical Curves
1260-15	Decision Sight Distance
1270-1	Climbing Lane Example
1270-2a	Speed Reduction Warrant: Performance for Trucks
1270-2b	Speed Reduction Warrant Example
1270-3	Auxiliary Climbing Lane
1270-4	Passing Lane Example
1270-5	Length of Passing Lanes
1270-6	Passing Lane Configurations
1270-7	Buffer Between Opposing Passing Lanes
1270-8	Auxiliary Passing Lane
1270-9	Emergency Escape Ramp Example
1270-10	Emergency Escape Ramp Length
1270-11	Rolling Resistance (R)
1270-12	Typical Emergency Escape Ramp
1270-13	Chain Up/Chain Off Area

1300-1	Intersection Design Considerations
1300-2	Median U-Turn Intersection Example
1300-3	Restricted Crossing U-Turn Intersection Example with Stop-control
1300-4	Displaced Left Turn Intersection Example
1310-1	Lane Alignment Taper Rate
1310-2	Ramp Terminal Intersection Details
1310-3	Median at Two-Way Ramp Terminal
1310-4	Intersection Balance Example
1310-5	Diamond Interchange With Advance Storage
1310-6	Initial Ranges for Right-Turn Corner (Simple Curve-Taper)
1310-7a	Left-Turn Storage Guidelines: Two-Lane, Unsignalized
1310-7b	Left-Turn Storage Guidelines: Four-Lane, Unsignalized
1310-8a	Left-Turn Storage Length: Two-Lane, Unsignalized (40 mph)
1310-8b	Left-Turn Storage Length: Two-Lane, Unsignalized (50 mph)
1310-8c	Left-Turn Storage Length: Two-Lane, Unsignalized (60 mph)
1310-9	Left-Turn Storage With Trucks (ft)
1310-10a	Median Channelization: Widening
1310-10b	Median Channelization: Median Width 11 ft or More
1310-10c	Median Channelization: Median Width 23 ft to 26 ft
1310-10d	Median Channelization: Median Width of More Than 26 ft
1310-10e	Median Channelization: Minimum Protected Storage
1310-10f	Median Channelization: Two-Way Left-Turn Lane
1310-11	Right-Turn Lane Guidelines
1310-12	Right-Turn Pocket and Right-Turn Taper
1310-13	Right-Turn Lane
1310-14	Acceleration Lane
1310-15a	Traffic Island Designs
1310-15b	Traffic Island Designs: Compound Curve
1310-15c	Traffic Island Designs
1310-16	U-Turn Spacing
1310-17	U-Turn Roadway
1310-18	U-Turn Median Openings
1310-19a	Sight Distance at Intersections
1310-19b	Sight Distance at Intersections
1320-1	Suggested Initial Design Ranges
1320-2	Radii-Speed Relationship on Approach Legs and R Value Relationships
1320-3	Intersection Sight Distance
1330-1	Responsibility for Facilities
1330-2	Example Continuous Green "T" (CGT) Intersection Layout

1330-3	Left-Turn Lane Configuration Examples
1330-4	Recommended Features for Intersections Near Rail Crossings
1330-5	Standard Intersection Movements, Head Numbers, and Phase Operation
1330-6	Detector Numbering Examples
1330-7a	Signal Display Placements – Key to Diagrams
1330-7b	Signal Displays for Single Lane Approach
1330-7c	Signal Display Mounting Locations for Multi-Lane Approaches
1330-7d	Signal Displays for Dedicated Left Turn Lanes
1330-7e	Signal Displays for Shared Through-Left Lanes – Multiple Through Lanes
1330-7f	Signal Displays for Shared Through-Right Lanes
1330-7g	Signal Displays for Dedicated Right Turn Lanes
1330-7h	Signal Displays for Multiple Turn Lanes
1330-8	Example Signal Display Placement for Skew Intersection
1330-9	Signal Display Maximum Heights
1330-10	Pedestrian Display Placement Requirements
1330-11	PPB Placement Requirements
1330-12a	PPB Placement on Vertical Shaft Poles
1330-12b	PPB Placement on Large Signal Standards
1330-13	Signal Display Surface Areas
1330-14	Timber Strain Pole Classes
1330-15	Fixed Vehicle Detection Placement
1330-16	Decision Zone Detection Placement
1330-17	Video Detector Placement
1330-18	Signal Display Layout for Rail Crossings
1330-19	Conduit and Conductor Sizes
1330-20	Phase Diagrams: Four-Way Intersections
1330-21	Phase Diagrams: Three-Way Intersections
1330-22	Phasing at Railroad Crossings
1340-1	Driveway Design Template SU-30 and Smaller
1340-2	Driveway Design Template SU-30 and Larger
1340-3	Driveway Sight Distance
1350-1	Sight Distance at Railroad Crossing
1350-2	Typical Pullout Lane at Railroad Crossing
1360-1	Basic Interchange Patterns
1360-2	Interchange Spacing
1360-3	Minimum Ramp Connection Spacing
1360-4	Ramp Design Speed
1360-5	Maximum Ramp Grade
1360-6	Ramp Widths

Exhibits

1360-7a	Lane Balance
1360-7b	Lane Balance
1360-8	Main Line Lane Reduction Alternatives
1360-9	Acceleration Lane Length
1360-10	Deceleration Lane Length
1360-11a	Gore Area Characteristics
1360-11b	Gore Area Characteristics
1360-12	Length of Weaving Sections
1360-13a	On-Connection: Single-Lane, Tapered
1360-13b	On-Connection: Single-Lane, Parallel
1360-13c	On-Connection: Two-Lane, Parallel
1360-13d	On-Connection: Two-Lane, Tapered
1360-14a	Off-Connection: Single-Lane, Tapered
1360-14b	Off-Connection: Single-Lane, Parallel
1360-14c	Off-Connection: Single-Lane, One-Lane Reduction
1360-14d	Off-Connection: Two-Lane, Tapered
1360-14e	Off-Connection: Two-Lane, Parallel
1360-15a	Collector-Distributor: Outer Separations
1360-15b	Collector Distributor: Off-Connections
1360-15c	Collector Distributor: On-Connections
1360-16	Loop Ramp Connections
1360-17	Temporary Ramps
1360-18	Interchange Plan
1410-1	Minimum Traveled Way Widths for Articulated Buses
1410-2	Typical HOV Lane Sections
1410-3	Roadway Widths for Two-Lane Ramps With an HOV Lane
1410-4a	Single-Lane Ramp Meter With HOV Bypass
1410-4b	Two-Lane Ramp Meter With HOV Bypass
1410-5a	Enforcement Area: One Direction Only
1410-5b	Enforcement Area: Median
1430-1	Bus Zone Dimensions
1430-2	Pullout for Bus Stop along a Road
1430-3	Bus Stop Pullouts: Arterial Streets
1430-4	Bus Zone and Pullout After Right Turn
1430-5	Bus Stop Accessibility Features
1430-6	Bus Berth Design
1430-7	Design Alternative for a Combination of Bus Berths at a Platform
1510-1	Pedestrian Circulation Paths
1510-2	Relationship Between Pedestrian Circulation Paths and Pedestrian Access Routes

1510-3	Obstructed Pedestrian Access Route
1510-4	Beveling Options
1510-5	Surface Discontinuities (Noncompliant)
1510-6	Sidewalks With Buffers
1510-7	Typical Sidewalk Designs
1510-8	Typical Driveways
1510-9	Perpendicular Curb Ramp
1510-10	Perpendicular Curb Ramp Common Elements
1510-11	Parallel Curb Ramp
1510-12	Parallel Curb Ramp Common Elements
1510-13	Combination Curb Ramp
1510-14	Typical Curb Ramp Drainage
1510-15	Unmarked Crosswalks
1510-16	Marked Pedestrian Crossing
1510-17	Vacant
1510-18	Midblock Pedestrian Crossing
1510-19	Obstructed Line of Sight at Intersection
1510-20	Improved Line of Sight at Intersection
1510-21	Curb Extension Examples
1510-22	Raised Islands With Curb Ramps and Pedestrian Cut-Throughs
1510-23	Clear Space for Pedestrian Pushbutton
1510-24a	Perpendicular Ramp Concurrent Clear Space Examples
1510-24b	Parallel Ramp Concurrent Clear Space Examples
1510-25	Reach Range for Pedestrian Pushbutton
1510-26	Pedestrian Railroad Crossings
1510-27	Pedestrian Railroad Warning Device
1510-28	Pedestrian Bridges
1510-29	Pedestrian Tunnel
1510-30	Access Ramp With Accessible Handrails
1510-31	Work Zones and Pedestrian Facilities
1515-1	Shared-Use Path
1515-2	Bicycle Design Speeds
1515-3	Two-Way Shared-Use Path: Independent Alignment
1515-4a	Two-Way Shared-Use Path: Adjacent to Roadway (\leq 35 mph)
1515-4b	Two-Way Shared-Use Path: Adjacent to Roadway ($>$ 35 mph)
1515-4c	Two-Way Shared-Use Path: Attached to Roadway ($>$ 35 mph)
1515-5	Shared-Use Path Side Slopes and Railing
1515-6	Shared-Use Path Landing Profile
1515-7	Shared-Use Path Landing and Rest Area

Exhibits

1515-8	Typical Redesign of a Diagonal Midblock Crossing
1515-9	Adjacent Shared-Use Path Intersection
1515-10	Roadway Crossing Refuge Area
1515-11	Shared-Use Path Bridge and Approach Walls
1515-12	Bridge and Pedestrian Rail
1515-13	Shared-Use Path in Limited Access Corridor
1515-14a	Stopping Sight Distance for Downgrades
1515-14b	Stopping Sight Distance for Upgrades
1515-15	Minimum Lengths for Crest Vertical Curves
1515-16	Lateral Clearance for Horizontal Curves
1520-1	Raised and Curb-Separated Bike Facility
1520-2	Separated Buffered Bike Lane
1520-3	Buffered Bike Lane
1520-4	Bike Lane
1520-5	Shared Lane Markings
1520-6a	Bicycle Facility Selection Chart – Interested, but Concerned Cyclists
1520-6b	Bicycle Facility Selection Chart – Confident Cyclists
1520-7	Approach Through Lanes
1520-8	Bike Box and Intersection Crossing Markings
1520-9	Two-Stage Left-Turn Queue Box
1520-10	Median Refuge Island for Cyclists
1520-11	Length of Solid Green Pavement Marking Preceding Conflict Area
1520-12	At-Grade Railroad Crossings
1520-13	Barrier Adjacent to Bicycle Facilities
1520-14a	Bike Facility Crossing On and Off Ramps
1520-14b	Bicycle Facility Crossing Single Lane On Ramp
1520-14c	Bicycle Facility Crossing Option for Dual Lane On-Ramp Configuration
1520-14d	Bicycle Facility Crossing Option for Dual Off-Ramp
1600-1	City and State Responsibilities and Jurisdictions
1600-2	Design Clear Zone Distance Table
1600-3	Design Clear Zone Inventory Form Link to Website for the form
1600-4	Recovery Area
1600-5	Design Clear Zone for Ditch Sections
1600-6	Guidelines for Embankment Barrier
1600-7	Mailbox Location and Turnout Design
1600-8	Glare Screens
1610-1	Concrete Barrier Placement Guidance: Assessing Impacts to Wildlife
1610-2	Traffic Barrier Locations on Slopes
1610-3	Longitudinal Barrier Deflection

1610-4	Longitudinal Barrier Flare Rates
1610-5	Barrier Length of Need on Tangent Sections
1610-6	Barrier Length of Need
1610-7	Barrier Length of Need on Curves
1610-8	W-Beam Guardrail Trailing End Placement for Divided Highways
1610-9	Beam Guardrail Installation on 6:1 to 10:1 Slopes
1610-10	Beam Guardrail Post Installation
1610-11	Vacant
1610-12	Guardrail Connections
1610-13	Transitions and Connections
1610-14a	Median Cable Barrier Placement
1610-14b	Roadside Cable Barrier Placement
1610-15	Cable Barrier Placement for Divided Highways
1610-16	Concrete Barrier Shapes
1610-17	Type 7 Bridge Rail Upgrade Criteria
1610-18	Thrie Beam Rail Retrofit Criteria
1620-1	Impact Attenuator Distance Beyond Length of Need
1710-1	WSDOT Safety Rest Area
1710-2	WSDOT's SRA Project and Programming Roles
1710-3	Additional Safety Rest Area Resources
1710-4	Roadside Facilities Level of Development
1710-5	Typical Truck Storage
1710-6	WSDOT Safety Rest Area Building – Adaptive Reuse Historic Preservation
1720-1	Truck Weigh Site: Multilane Highways
1720-2	Truck Weigh Site: Two-Lane Highways
1720-3	Vehicle Inspection Installation
1720-4	Minor Portable Scale Site
1720-5	Major Portable Scale Site
1720-6	Small Shoulder Site
1720-7	Large Shoulder Site
1720-8	MOU Related to Vehicle Weighing and Equipment: Inspection Facilities on State Highways

- 300.01 General
- 300.02 WSDOT Project Delivery
- 300.03 Design Documentation and Records Retention Policy
- 300.04 Project Design Approvals
- 300.05 FHWA Oversight and Approvals
- 300.06 Project Documents and Approvals
- 300.07 Process Review
- 300.08 References

300.01 General

This chapter provides the WSDOT design procedures, documentation and approvals necessary to deliver successful projects on the transportation network in Washington, including projects involving the Federal Highways Administration.

This chapter presents critical information for design teams, including:

- WSDOT’s Project Development process.
- Design documentation tools, procedures, and records retention policy.
- Major Project approvals including Design Approval, Project Development Approval, Basis of Design, Design Analysis, and other specific project documents for design-bid-build and for design-build delivery methods.
- FHWA oversight and approvals on Projects of Division Interest (PoDI).
- WSDOT and FHWA approvals for non-PoDI projects including Interstate new and reconstruction and other specific documents as shown in the approvals exhibits.
- Information about conducting project process reviews.
- Additional references and resources.

For local agency and developer projects on state highways, design documentation is also needed. It is retained by the region office responsible for the project oversight, in accordance with the WSDOT records retention policy. All participants in the design process are to provide the appropriate documentation for their decisions. See [300-04\(3\)](#) for information about the approval process and authority. For more information about these types of projects, see the [Local Agency Guidelines](#) and [Development Services Manual](#) available at the Publications Services Index website:

www.wsdot.wa.gov/Publications/Manuals/index.htm

For operational changes identified by the Traffic Office Low Cost Enhancement or Field Assessment Program that are included in a project, design documentation is also needed. It is retained by the region office responsible for the project oversight, in accordance with the WSDOT records retention policy. This documentation will be developed by the region Traffic

Office in accordance with HQ Traffic Office direction and included in the design documentation for the project.

For emergency projects, also refer to the [Emergency Relief Procedures Manual](#). It provides the legal and procedural guidelines for WSDOT employees to prepare all necessary documentation to respond to, and recover from, emergencies and disasters that affect the operations of the department.

300.02 WSDOT Project Delivery

A project, and its delivery method, is developed in accordance with all applicable procedures, Executive Orders, Directives, Instructional Letters, Supplements, and manuals; the Washington State Highway System Plan; approved corridor sketches and planning studies; the FHWA/WSDOT Stewardship and Oversight Agreement; scoping phase documentation, and the Basis of Design.

The delivery method is determined using the WSDOT Project Delivery Method Selection Guidance Memorandum found here:

www.wsdot.wa.gov/Projects/delivery/designbuild/PDMSG.htm

See the implementation memorandum for procedural policy and guidance in the selection of probable and final project delivery method, timing for these determinations, and approval and endorsement levels.

The region develops and maintains documentation for each project using this chapter and the Project File / Design Documentation Package checklists (see [300.03\(3\)](#))

Refer to the [Plans Preparation Manual](#) for PS&E documentation. Exhibit 300-4 is an example checklist of recommended items to be turned over to the construction office at the time of project transition. An expanded version is available here:

www.wsdot.wa.gov/design/projectdev/

300.02(1) Environmental Requirements

All projects involving a federal action require National Environmental Policy Act (NEPA) documentation. WSDOT uses the Environmental Review Summary (ERS) portion of Project Summary for FHWA concurrence on the environmental class of action (EIS/EA/CE). The environmental approval levels are shown in [Exhibit 300-2](#).

Upon receipt of the ERS approval for projects requiring an EA or EIS under NEPA, the region proceeds with environmental documentation, including public involvement, appropriate for the magnitude and type of the project (see [Chapter 210](#) and [WSDOT Community Engagement Plan](#)).

300.02(2) Real Estate Acquisition

Design Approval and approval of right of way plans are required prior to acquiring property. A temporary construction easement may be acquired prior to Design Approval for State funded projects and with completion of NEPA for Federally funded projects. For early acquisition of right of way, consult the Real Estate Services Office, the April 2, 2013 memorandum on early acquisition policy, and [Right of Way Manual](#) Chapter 6-3.

300.03 Design Documentation and Records Retention Policy

300.03(1) Purpose

Design documentation records the evaluations and decisions by the various disciplines that result in design recommendations. Design assumptions and decisions made prior to and during the scoping phase are included. Changes that occur throughout project development are documented. Required justifications and approvals are also included.

300.03(2) Certification of Documents by Licensed Professionals

All original technical documents must bear the certification of the responsible licensee as listed in [Executive Order E 1010](#).

300.03(3) Project File and Design Documentation Package

The Project File and Design Documentation Package include documentation of project work, including planning; scoping; community engagement; environmental action; the Basis of Design; right of way acquisition; Plans, Specifications, and Estimates (PS&E) development; project advertisement; and construction.

The **Project File (PF)** contains the documentation for planning, scoping, programming, design, approvals, contract assembly, utility relocation, needed right of way, advertisement, award, construction, and maintenance review comments for a project. A Project File is completed for all projects and is retained by the region office responsible for the project. Responsibility for the project may pass from one office to another during the life of a project, and the Project File follows the project as it moves from office to office. With the exception of the DDP, the Project File may be purged when retention of the construction records is no longer necessary.

See the Project File checklist for documents to be preserved in the Project File:

www.wsdot.wa.gov/Design/Support.htm

The **Design Documentation Package (DDP)** is a part of the Project File and preserves the decision documents generated during the design process. In each package, a summary (list) of the documents included is recommended. The DDP documents and explains design decisions, design criteria, and the design process that was followed. The DDP is retained in a permanent retrievable file for a period of 75 years, in accordance with WSDOT records retention policy.

The Basis of Design, Design Parameters, Alternatives Comparison Table, and Design Analyses are tools developed to document WSDOT practical design and decisions. Retain these in the DDP.

Refer to the remainder of this chapter and DDP checklist for documents to be preserved in the DDP. See Design Documentation Package Checklist here:

www.wsdot.wa.gov/Design/Support.htm

300.04 Project Design Approvals

This section describes WSDOT's project design milestones known as Design Approval and Project Development Approval. They are required approvals regardless of delivery method chosen by WSDOT. Many of the documents listed under these milestones are described further in [300.06](#).

Information pertaining to FHWA approvals and oversight is provided in [300.05](#) which describes Projects of Division Interest (PoDI) which are governed by a separate plan that specifies FHWA and State responsibilities for the project. Documents for projects requiring FHWA review, Design Approval, and Project Development Approval are submitted through the HQ Design Office.

300.04(1) Design Approval

When the Project Summary (see [300.06](#)) documents are approved, and the region is confident that the proposed design adequately addresses the purpose and need for the project, a Design Approval should be pursued and granted at this early stage. Early approval is beneficial at this point in the design phase and is most relevant to larger projects with longer PE phases. Design Approval establishes the policy for three years. This is a benefit for longer PE phases in that it avoids design changes due to policy updates during that time and provides consistency when purchasing right of way or producing environmental documentation.

The items below are included in the combined Design Approval/Project Development Approval Package. Design Approval may occur prior to NEPA approval. Generally, Design Approval will not be provided prior to an Access Revision Report being approved on an Interstate project. Approval levels for design and PS&E documents are presented in [Exhibits 300-1](#) through [300-3](#).

The following items are to be provided for Design Approval. See [300.06](#) for additional information.

- Stamped cover sheet *
- A reader-friendly Design Approval memorandum that describes the project
- Project Vicinity Map
- Project Summary documents
- Basis of Design (BOD) *
- Alternatives Comparison Table
- Design Parameter Sheets
- Safety Analysis or Crash Analysis Report (CAR) *
- Current Project Design Analysis(s) *
- List of known Design Analysis documents (contact your ASDE)
- List of known Maximum Extent Feasible (MEF) documents (contact your ASDE)
- Channelization plans, intersection plans, or interchange plans (if applicable)
- Alignment plans and profiles (if project significantly modifies either the existing vertical or horizontal alignment)
- Current cost estimate

* Include the original approved documents

Design Approval is entered into the Design Documentation Package and remains valid for three years or as approved by the HQ Design Office.

- If the project is over this three-year period and has not advanced to Project Development Approval, evaluate policy changes or revised design criteria that are adopted by the department during this time to determine whether these changes would have a significant impact on the scope or schedule of the project.
- If it is determined that these changes will not be incorporated into the project, document this decision with a memo from the region Project Development Engineer that is included in the DDP.
- For an overview of design policy changes, consult the Detailed Chronology of Design Manual revisions: www.wsdot.wa.gov/design/policy/default.htm

300.04(1)(a) Design-Build Projects

Design Approval applies to design-build projects and is required prior to issuing a design-build request for proposal (RFP).

Environmental documentation completion is recommended prior to issuing RFP, but is required prior to contract execution.

300.04(2) Project Development Approval

When all project development documents are completed and approved, Project Development Approval is granted by the approval authority designated in [Exhibit 300-1](#). The Project Development Approval becomes part of the DDP.

Refer to this chapter and the DDP checklist for design documents that may lead to Project Development Approval. Exhibits [300-1](#) through [300-3](#) provide approval levels for project design and PS&E documents.

The following items must be approved prior to Project Development Approval:

- Stamped cover sheet
- A reader friendly Project Development Approval (PDA) Memorandum that describes the project
- Project Vicinity Map
- Design Approval documents (and any supplements)
 - Updated Basis of Design (BOD) *
 - Updated list of Project Design analysis(s) *
 - Updated cost estimate
- NEPA Approvals
- SEPA Approvals

* Include the original approved documents

Project Development Approval remains valid for three years.

- Evaluate policy changes or revised design criteria that are adopted by the department during this time to determine whether these changes would have a significant impact on the scope or schedule of the project.
- If it is determined that these changes will not be incorporated into the project, document this decision with a memo from the region Project Development Engineer that is included in the DDP.

- For an overview of design policy changes, consult the Detailed Chronology of Design Manual revisions: www.wsdot.wa.gov/design/policy/default.htm

300.04(2)(a) Design-Build Projects

For design-build projects, the design-builder shall refer to the project Request for Proposal (RFP) for specification on final and intermediate deliverables and final records for the project. Project Development Approval is required prior to project completion.

It is a prudent practice to start the compilation of design documentation early in a project and to acquire Project Development Approval before the completion of the project. At the start of a project, it is critical that WSDOT project administration staff recognize the importance of all required documentation and how it will be used in the design-build project delivery process.

300.04(3) Local Agency and Developer Services Approvals

Local agencies or developers proposing projects for construction on state highways, or within WSDOT jurisdiction on city streets that serve as part of state highways per RCW 47.24, are required to document design decisions using the WSDOT design documentation policy (see 300.03) and as follows. The local agency or developer is required to document all decisions that change one or more design elements (see 1105.02) using the Basis of Design. Documentation is submitted to WSDOT for review and approval according to Exhibit 300-5. Where FHWA approval is indicated, WSDOT will forward submitted information to FHWA for their approval and transmit FHWA's approval, comments, and/or questions back to the submitter.

In cases where design decisions are imposed on the local agency or developer by WSDOT or FHWA, in order to secure their approval, those specific decisions are to be documented by WSDOT. Note that the requirement to submit a Basis of Design for approval may be waived by the approving authority designated in Exhibit 300-5, based on the criterion in 1100.10(1)(a). When a Region is the approval authority for the BOD and is considering an exemption, the Region approving authority can assume the role of the Assistant State Design Engineer to determine if an exemption is appropriate. For more information about the Basis of Design, see Chapters 1100 through 1106.

300.05 FHWA Oversight and Approvals

The March 2015 Stewardship & Oversight (S&O) [Agreement](#) between WSDOT and FHWA Washington Division created new procedures and terminology associated with FHWA oversight and approvals. One such term, and new relevant procedure, is "Projects of Division Interest" (PoDI) described below.

For all projects, on the National Highway System (NHS), the level of FHWA oversight and approvals can vary for numerous reasons such as type of project, the agency doing the work, PoDI/non-PoDI designation, and funding sources. Oversight and funding do not affect the level of design documentation required for a project.

Documents for projects requiring FHWA review, Design Approval, and Project Development Approval are submitted through the HQ Design Office.

300.05(1) FHWA Projects of Division Interest (PoDI)

Projects of Division Interest (PoDI) are a primary set of projects for which FHWA determines the need to exercise oversight and approval authority. These are projects that have an elevated risk, contain elements of higher risk, or present a meaningful opportunity for FHWA involvement to enhance meeting program or project objectives. Collaborative identification of these projects allows FHWA Washington Division to concentrate resources on project stages or areas of interest. It also allows WSDOT to identify which projects are PoDIs and plan for the expected level of engagement with FHWA.

The Stewardship & Oversight Agreement generally defines Projects of Division Interest as:

- Major Projects (A federal aid project with total cost >\$500M)
- TIGER Discretionary Grant Projects
- NHS Projects that may require FHWA Project or Program Approvals
- Projects Selected by FHWA based on Risk or Opportunity

The S&O Agreement also states: Regardless of retained project approval actions, any Federal-aid Highway Project either on or off the NHS that the Division identifies as having an elevated level of risk can be selected for risk-based stewardship and oversight and would then be identified as a PoDI.

For each project designated as a PoDI, FHWA and WSDOT prepare a Project-Specific PoDI Stewardship & Oversight Agreement which identifies project approvals and related responsibilities specific to the project.

300.05(2) FHWA Approvals on Non-PoDI Projects

On projects that are not identified as PoDI, FHWA approvals are still required for various items as shown in [Exhibit 300-1](#). For example, FHWA approval is still required for any new or revised access point (including interchanges, temporary access breaks, and locked gate access points) on the Interstate System, regardless of funding source or PoDI designation (see [Chapter 550](#)).

The [Exhibit 300-1](#) approval table refers to New/Reconstruction projects on the Interstate. New/Reconstruction projects include the following types of work:

- Capacity changes: add a through lane, convert a general-purpose (GP) lane to a special-purpose lane (such as an HOV or HOT lane), or convert a high-occupancy vehicle (HOV) lane to GP.
- Other lane changes: add or eliminate a collector-distributor or auxiliary lane. (A rural truck climbing lane that, for its entire length, meets the warrants in Chapter 1270 is not considered new/reconstruction.)
- New interchange.
- Changes in interchange type such as diamond to directional or adding a ramp.
- New or replacement bridge (on or over, main line, or interchange ramp).
- New Safety Rest Areas Interstate.

Documents for projects requiring FHWA review, Design Approval, and Project Development Approval are submitted through the HQ Design Office.

300.06 Project Documents and Approvals

This section lists several major design documents generated for a project and they all are retained in the Design Documentation Package. The Basis of Design, Alternatives Comparison Table, Design Parameters, and Design Analyses are tools used to document practical design decisions.

See the Project File and Design Documentation Package checklists described in [300.03\(3\)](#) for complete list of documents.

For approval levels see Exhibits [300-1](#) through [300-3](#) or a project-specific S&O Agreement for PoDI projects.

300.06(1) Project Summary

The Project Summary provides information on the results of the scoping phase; links the project to the Washington State Highway System Plan and the Capital Improvement and Preservation Program (CIPP); and documents the design decisions, the environmental classification, and agency coordination. The Project Summary is developed and approved before the project is funded for design and construction, and it consists of the ERS, and PD documents. The Project Summary database contains specific online instructions for completing the documents.

300.06(1)(a) Project Definition (PD)

The PD identifies the various disciplines and design elements that are anticipated to be encountered in project development. It also states the purpose and need for the project, the program categories, and the recommendations for project phasing. The PD is initiated early in the scoping phase to provide a basis for full development of the ERS, schedule, estimate, Basis of Estimate, and Basis of Design (where indicated in scoping instructions). If circumstances necessitate a change to an approved PD, the project manager and the regional program manager will document the change according to the CPDM Change Management process. For more information, see the [Program Management Manual](#), Chapter 9 Managing Change.

300.06(1)(b) Environmental Review Summary (ERS)

The ERS lists the potentially required environmental permits and approvals, environmental classifications, and environmental considerations. The ERS is prepared during the scoping phase and is approved by the region. If there is a change in the PD, the information in the ERS must be reviewed and revised to match the rest of the Project Summary. For actions classified as a CE under NEPA, the approved ERS becomes the ECS when the project is funded and moves to design. The region may revise the ECS as appropriate (usually during final design) as the project advances. The ECS serves as the NEPA environmental documentation for CE projects. The region Environmental Manager approves the ECS and may send it to FHWA for their approval. The ERS/ECS database includes fully integrated help screens that provide detailed guidance. Contact your region Environmental Office for access.

300.06(2) **Basis of Design (BOD)**

The BOD captures important decisions that control the outcome of a project, including identified performance needs, context, design controls and design elements necessary to design the practical alternative. When applicable attach supporting documents, such as the Alternatives Comparison Table and Design Parameters to the BOD. (See [Chapter 1100](#) for further discussion on these documents). The Basis of Design (BOD) is part of the DDP.

300.06(3) **Basis of Estimate (BOE)**

The BOE contains the assumptions, risks, and information used to develop an estimate. The BOE is reviewed and updated during each phase of a project. The confidence of the estimate, either overall or for particular items, is also identified within the BOE. Generally, the BOE is started during the scoping phase because it is required for Project Summary approval; however, in more complex situations the BOE may have begun during the planning phase. For more information, see the [Cost Estimating Manual for WSDOT Projects](#).

300.06(4) **Design Analysis**

A Design Analysis is a process and tool used to document important design decisions, summarizing information needed for an approving authority to understand and support the decision.

A Design Analysis is required where a dimension chosen for a design element that will be changed by the project is outside the range of values provided for that element in the *Design Manual*. A Design Analysis is also required where the need for one is specifically referenced in the *Design Manual*.

A region approved Design Analysis is required if a dimension or design element meets current AASHTO guidance adopted by the Federal Highway Administration (FHWA), such as A Policy on Geometric Design of Highways and Streets, but is outside the corresponding *Design Manual* criteria. See [Exhibit 300-1](#) for Design Analysis approval authorities.

In the case of a shoulder width reduction at an existing bridge pier or abutment, sign structure or luminaire base in a run of median barrier, the Design Parameter Sheet may be used instead of a Design Analysis to document the dimensioning decision for the shoulder at that location.

A template is available to guide the development of the Design Analysis document here:

www.wsdot.wa.gov/design/support.htm.

Email a PDF copy of all Region approved Design Analyses to the ASDE supporting your region.

300.07 **Process Review**

The Assistant State Design Engineers work with the regions on project development and conduct process reviews on projects. The process review is done to provide reasonable assurance that projects are prepared in compliance with established policies and procedures and that adequate records exist to show compliance with state and federal requirements. Process reviews are conducted by WSDOT, FHWA, or a combination of both.

The design and PS&E process review is performed at least once each year by the HQ Design Office. The documents used in the review process are the Design Documentation Package

Checklist(s), Basis of Design, Basis of Estimate, the PS&E Review Checklist, and the PS&E Review Summary. These are generic forms used for all project reviews. Copies of these working documents are available for reference when assembling project documentation. The HQ Design Office maintains current copies at: www.wsdot.wa.gov/design/support.htm.

Each project selected for review is examined completely and systematically beginning with the scoping phase (including planning documents) and continuing through contract plans and, when available, construction records and change orders. Projects are normally selected after contract award. For projects having major traffic design elements, the HQ Traffic Operations Office is involved in the review. The WSDOT process reviews may be held in conjunction with FHWA process reviews.

The HQ Design Office schedules the process review and coordinates it with the region and FHWA.

300.07(1) Process Review Agenda

When conducting joint process review with FHWA, the Process Review Report will outline specific agenda items.

A WSDOT process review follows this general agenda:

1. Review team meets with region personnel to discuss the objective of the review.
2. Review team reviews the design and PS&E documents, construction documents, and change orders (if available) using the checklists.
3. Review team meets with region personnel to ask questions and clarify issues of concern.
4. Review team meets with region personnel to discuss findings.
5. Review team submits a draft report to the region for comments and input.
6. If the review of a project shows a serious discrepancy, the region design authority is asked to report the steps that will be taken to correct the deficiency.
7. Process review summary forms are completed.
8. Summary forms and checklists are evaluated by the Director & State Design Engineer, Development Division.
9. Findings and recommendations of the Director & State Design Engineer, Development Division, are forwarded to the region design authority for action and/or information within 30 days of the review.

300.08 References

300.08(1) Federal/State Laws and Codes

[23 Code of Federal Regulations \(CFR\) 635.111](#), Tied bids

[23 CFR 635.411](#), Material or product selection

[Revised Code of Washington \(RCW\) 47.28.030](#), Contracts – State forces – Monetary limits – Small businesses, minority, and women contractors – Rules

[RCW 47.28.035](#), Cost of project, defined

“Washington Federal-Aid Stewardship Agreement,”

www.wsdot.wa.gov/publications/fulltext/design/ASDE/2015_Stewardship.pdf

300.08(2) Design Guidance

WSDOT Directional Documents Index, including the one listed below:

<http://wwwi.wsdot.wa.gov/publications/policies>

[Executive Order E 1010](#), “Certification of Documents by Licensed Professionals,” WSDOT

WSDOT technical manuals, including those listed below:

www.wsdot.wa.gov/publications/manuals/index.htm

- *Advertisement and Award Manual*, M 27-02, WSDOT
- *Cost Estimating Manual for WSDOT Projects*, M 3034, WSDOT
- *Design Manual*, M 22-01, WSDOT
- *Emergency Relief Procedures Manual*, M 3014, WSDOT
- *Environmental Manual*, M 31-11, WSDOT
- *Hydraulics Manual*, M 23-03, WSDOT
- *Highway Runoff Manual*, M 31-16, WSDOT
- *Plans Preparation Manual*, M 22-31, WSDOT
- *Roadside Manual*, M 25-30, WSDOT
- *Roadside Policy Manual*, M 3110, WSDOT
- *Temporary Erosion and Sediment Control Manual*, M 3109, WSDOT

Limited Access and Managed Access Master Plan, WSDOT

www.wsdot.wa.gov/design/accessandhearings/

Program Management Manual, M 3005, WSDOT

<http://wwwi.wsdot.wa.gov/publications/manuals/fulltext/M3005/PMM.pdf>

Washington State Highway System Plan, WSDOT

www.wsdot.wa.gov/planning/

300.08(3) Supporting Information

[A Policy on Geometric Design of Highways and Streets](#) (Green Book), AASHTO, 2011

[Mitigation Strategies for Design Exceptions](#), FHWA, July 2007. This publication provides detailed information on design exceptions and mitigating the potential adverse impacts to highway safety and traffic operations.

[Highway Capacity Manual](#) (HCM), latest edition, Transportation Research Board, National Research Council

[Highway Safety Manual](#) (HSM), AASHTO

Exhibit 300-1 Approval Authorities

Project Type	Basis of Design (BOD) Approval	Design Analysis Approval [1] [2] [11]	Design Approval and Project Development Approval
Project of Division Interest (PoDI)	[10]	[10]	[10]
Interstate			
New/Reconstruction Regardless of funding source [3]	FHWA	FHWA	FHWA [4]
Intelligent Transportation Systems (ITS) Improvement Project over \$1 million Preservation project	HQ Design HQ Design	HQ Design HQ Design	HQ Design Region
All Other Regardless of funding source [12]	HQ Design	HQ Design	Region
National Highway System (NHS)			
Projects on all limited access highways, or on managed access highways outside of incorporated cities and towns	HQ Design	HQ Design [5]	Region
Projects on managed access highways within incorporated cities and towns Inside curb or EPS [6][7] Outside curb or EPS	HQ Design City/Town	HQ Design HQ LP	Region City/Town
Non-National Highway System (Non-NHS)			
Improvement projects on all limited access highways, or on managed access highways outside of incorporated cities and towns	HQ Design	HQ Design	Region
Improvement projects on managed access highways within incorporated cities and towns [9] Inside curb or EPS [6][7] Outside curb or EPS	HQ Design City/Town	HQ Design HQ LP	Region City/Town
Preservation projects on limited access highway, or on managed access highways outside of incorporated cities and towns, or within unincorporated cities and towns [8]	Region	Region	Region
Preservation projects on managed access highways within incorporated cities and towns [8] Inside curb or EPS [6][7] Outside curb or EPS	Region City/Town	Region HQ LP	Region City/Town

FHWA = Federal Highway Administration

HQ = WSDOT Headquarters

HQ LP = WSDOT Headquarters Local Programs Office

EPS = Edge of paved shoulder where curbs do not exist

NHS = National Highway System

www.wsdot.wa.gov/mapsdata/travel/hpms/NHSRoutes.htm

For table notes, see the following page.

Exhibit 300-1 Approval Authorities (continued)**Notes:**

- [1] These approval levels also apply to Design Analysis processing for local agency and developer work on a state highway.
- [2] See [300.06\(4\)](#). Where still encountered in the *Design Manual* replace the term *deviation* with *Design Analysis*.
- [3] For definition of New/Reconstruction, see [300.05\(2\)](#).
- [4] FHWA will provide Design Approval prior to NEPA Approval, but will not provide Project Development Approval until NEPA is complete.
http://www.wsdot.wa.gov/publications/fulltext/design/ASDE/2015_Stewardship.pdf
- [5] For guidance on the need for Design Analyses related to access management, see Chapters [530](#) and [540](#).
- [6] Includes raised medians (see [Chapter 1600](#)).
- [7] Curb ramps are still included (see [Chapter 1510](#)).
- [8] For Bridge Replacement projects in the Preservation program, follow the approval level specified for Improvement projects.
- [9] Refer to [RCW 47.24.020](#) for more specific information about jurisdiction and responsibilities that can affect approvals.
- [10] Projects of Division Interest (PoDI) must receive FHWA approvals per the PoDI Agreement regardless of funding source or project type.
- [11] A region approved Design Analysis is required if a dimension or design element meets current AASHTO guidance adopted by the Federal Highway Administration (FHWA), such as *A Policy on Geometric Design of Highways and Streets*, but is outside the range of corresponding *Design Manual* criteria. Email a PDF copy of all Region approved Design Analyses to the ASDE supporting your region.
- [12] Reduction of through lane or shoulder widths (regardless of project type) requires FHWA review and approval, except shoulder reductions for existing bridge pier or abutment, sign structure or luminaire base in a run of median barrier as allowed by [300.06\(4\)](#).

Exhibit 300-2 Approvals

Item	Approval Authority		
	Region	HQ	FHWA
Program Development			
Work Order Authorization		X	X [1]
Public Hearings			
Corridor Hearing Summary		X [2]	
Design Hearing Summary		X [3]	X [8]
Limited Access Hearing Plan		X [4]	
Limited Access Findings and Order		X [5]	
Environmental Document			
Class I NEPA (EIS)		[7]	X
SEPA (EIS)		X	
Class II NEPA – Categorical Exclusion (CE) Documented in ECS form	X		
SEPA – Categorical Exemption (CE)	X		
Class III NEPA – Environmental Assessment (EA)		[7]	X
SEPA Environmental Checklist & Determination of Non-Significance (DNS)	X		
Design			
Basis of Design (BOD)	[9]	[9]	[9]
Intersection Control Type	X [20]	X [22]	
Experimental Features		X	X
Environmental Review Summary	X		
Final Project Definition		X [10]	
Interstate Access Revision Report		[7]	X
Any Break in Interstate Limited Access		[7]	X
Non-Interstate Access Revision Report		X	
Break in Partial or Modified Limited Access		X	
Intersection or Channelization Plans	X		
Right of Way Plans	[11]	X	
Monumentation Map	X		
Materials Source Report		X [12]	
Pavement Determination Report		X [12]	
Roundabout Geometric Design (see Chapter 1320 for guidance)	X		
Resurfacing Report		X [12]	
Signal Permits	X [13]		
Geotechnical Report		X [12]	
Tied Bids	X [14]		
Table continued on the following page, which also contains the notes.	Approval Authority		
	Region	HQ	FHWA

Exhibit 300-2 Approvals (continued)			
Item			
Bridge Design Plans (Bridge Layout)	X	X	
Preliminary Bridge Plans for Unusual/Complex Bridges on the Interstate		[7]	X
Structures Requiring TS&Ls		X	
Hydraulic Report	X [15]	[15]	
Preliminary Signalization Plans		X [6][18]	
Signalization Plans	X [20]		
Illumination Plans	X [20]		
Intelligent Transportation System (ITS) Plans	X [20]		
ITS Systems Engineering Analysis Worksheet (Exhibit 1050-2)	X [20]		
Rest Area Plans		X	
Roadside Restoration Plans	X [16]	X [17]	
Planting Plans	X [16]	X [17]	
Grading Plans	X		
Continuous Illumination – Main Line		X [18]	
Tunnel Illumination		X [18]	
High Mast Illumination		X [18]	
Work Zone Transportation Management Plan/Traffic Control Plan	X [20]		
Public Art Plan – Interstate (see Chapter 950)	X [16]	X [17][21]	X
Public Art Plan – Non-Interstate (see Chapter 950)	X [16]	X [17][21]	
Crash Analysis Report	X [20]	X	
ADA Maximum Extent Feasible Document (see Chapter 1510)	X	X	
<p>Notes:</p> <p>[1] Federal-aid projects only.</p> <p>[2] Approved by Assistant Secretary, Engineering & Regional Operations.</p> <p>[3] Approved by Director & State Design Engineer, Development Division.</p> <p>[4] Approved by Right of Way Plans Manager.</p> <p>[5] Refer to Chapter 210 for approval requirements.</p> <p>[6] Final review & concurrence required at the region level prior to submittal to approving authority.</p> <p>[7] Final review & concurrence required at HQ prior to submittal to approving authority.</p> <p>[8] On Interstate projects, the Director & State Design Engineer, Development Division, (or designee) submits the approved design hearing summary to the FHWA for federal approval. (See Chapter 210.)</p> <p>[9] See Exhibit 300-1 for BOD Approvals.</p> <p>[10] Approved by HQ Capital Program Development and Management (CPDM).</p> <p>[11] Certified by the responsible professional licensee.</p> <p>[12] Submit to HQ Mats Lab for review and approval.</p> <p>[13] Approved by Regional Administrator or designee.</p> <p>[14] Per 23 CFR 635.111.</p> <p>[15] See the Hydraulics Manual for approvals levels.</p> <p>[16] Applies to regions with a Landscape Architect.</p> <p>[17] Applies to regions without a Landscape Architect.</p> <p>[18] Approved by State Traffic Engineer.</p> <p>[19] Vacant.</p> <p>[20] Region Traffic Engineer or designee.</p> <p>[21] The State Bridge and Structures Architect reviews and approves the public art plan (see Chapter 950 for further details on approvals).</p> <p>[22] State Traffic Engineer or designee.</p>			

Exhibit 300-3 PS&E Process Approvals NHS (including Interstate) and Non-NHS

Item	Headquarters or Region Approval Authority
DBE/training goals * **	Office of Equal Opportunity
Right of way certification for federal-aid projects***	Region; HQ Real Estate Services Office or HQ Local Programs Right of Way Manager [7]
Right of way certification for state or local funded projects***	Region; HQ Real Estate Services Office or HQ Local Programs Right of Way Manager
Railroad agreements	HQ Design Office
Work performed for public or private entities *	Region [1][2]
State force work *	Region [3][4]
Use of state-furnished materials *	Region [3][4]
Work order authorization	Capital Program Development and Management [5]
Ultimate reclamation plan approval through DNR	Region
Proprietary item use *	[4][6] HQ Design Office
Mandatory material sources and/or waste sites *	Region [4]
Nonstandard bid item use *	Region
Incentive provisions	HQ Construction Office
Nonstandard time for completion liquidated damages *	HQ Construction Office
Interim liquidated damages *	Transportation Data, GIS & Modeling Office
<p>Notes: FHWA PS&E Approval has been delegated to WSDOT unless otherwise stated differently in a Project Specific PoDI S&O Agreement.</p> <p>[1] This work requires a written agreement. [2] Region approval subject to \$250,000 limitation. [3] Use of state forces is subject to \$60,000 limitation and \$100,000 in an emergency situation, as stipulated in RCWs 47.28.030 and 47.28.035. Region justifies use of state force work and state-furnished materials and determines if the work is maintenance or not. HQ CPDM reviews to ensure process has been followed. [4] Applies only to federal-aid projects; however, document for all projects. [5] Prior FHWA funding approval required for federal-aid projects. [6] The HQ Design Office is required to certify that the proprietary product is either: (a) necessary for synchronization with existing facilities, or (b) a unique product for which there is no equally suitable alternative. [7] For any federal aid project FHWA only approves Right of Way Certification 3s (All R/W Not Acquired), WSDOT approves Right of Way Certification 1s and 2s for all other federal aid projects.</p> <p>References: * Plans Preparation Manual ** Advertisement and Award Manual *** Right of Way Manual</p>	

Exhibit 300-4 Design to Construction Transition Project Turnover Checklist Example

This checklist is recommended for use when coordinating project transition from design to construction.

1. Survey

- End areas (cut & fill)
- Staking data
- Horizontal/Vertical control
- Monumentation/Control information

2. Design Backup

- Index for all backup material
- Backup calculations for quantities
- Geotech shrink/swell assumptions
- Basis of Design, Design decisions and constraints
- Approved Design Analyses
- Hydraulics/Drainage information
- Clarify work zone traffic control/workforce estimates
- Geotechnical information (report)
- Package of as-builts used (which were verified) and right of way files
- Detailed assumptions for construction CPM schedule (working days)
- Graphics and design visualization information (aerials)
- Specific work item information for inspectors (details not covered in plans)
- Traffic counts
- Management of utility relocation

3. Concise Electronic Information With Indices

- Detailed survey information (see Survey above)
- Archived InRoads data
- Only one set of electronic information
- "Storybook" on electronic files (what's what)
- CADD files

4. Agreements, Commitments, and Issues

- Agreements and commitments by WSDOT
- RES commitments
- Summary of environmental permit conditions/commitments
- Other permit conditions/commitments
- Internal contact list
- Construction permits
- Utility status/contact
- Identification of the work elements included in the Turnback Agreement (recommend highlighted plan sheets)

5. Construction Support

- Assign a Design Technical Advisor (Design Lead) for construction support

An expanded version of this checklist is available at: www.wsdot.wa.gov/design/projectdev

Exhibit 300-5 Local Agency and Developer Approvals

<u>Project Type</u>	<u>Basis of Design (BOD) Approval</u>	<u>Design Analysis Approval</u>	<u>Design Approval and Project Development Approval</u>
<u>Interstate</u>			
All projects	<u>FHWA</u>	<u>FHWA</u>	<u>FHWA</u>
<u>Highways (NHS) & (Non-NHS)</u>			
<u>Projects on limited access highways</u>	<u>HQ Design</u>	<u>HQ Design</u>	<u>Region</u>
<u>Projects on managed access highways</u>	<u>Region</u>	<u>HQ Design</u>	<u>Region</u>

540.01	General	540.07	Permitting and Design Documentation
540.02	Design Considerations	540.08	Other Considerations
540.03	Managed Access Highway Classes	540.09	Preconstruction Conference
540.04	Corner Clearance Criteria	540.10	Adjudicative Proceedings
540.05	Access Connection Categories	540.11	Documentation
540.06	Access Connection Permit	540.12	References

540.01 General

Access management is the systematic regulation of the location, spacing, design, and operation of driveway, city street, and county road connections to state highways. This chapter describes the access management process for granting permission to connect to managed access highways within cities and unincorporated areas. For an overview of access control, references to related state laws and codes, and definitions of terminology for this chapter, see [Chapter 520, Access Control](#).

In Washington State, managed access highways include all state highways that are not limited access highways. State highways that are planned for or established as limited access, are treated as managed access highways until the limited access rights are acquired.

The Access Control Tracking System Limited Access and Managed Access Master Plan (Access Master Plan) identifies not only the limits of limited access control, but also managed access control segments. The current managed access classification is based on access connection densities, distance between access connections, spacing of intersections, and context (see [Washington Administrative Code \(WAC\) 468-52-040](#)). The existing access classification is periodically updated by Headquarters (HQ) with region input to reflect changes on a corridor segment. Conditions may have changed since the Access Master Plan was envisioned or the last managed access classification update. On non-freeways it is important to consider the current classification and any classifications previously planned, and determine the access design control most appropriate for the agreed context (see Chapters [1102](#) and [1103](#) for context and design control guidance, respectively). The Access Master Plan database is available at:

www.wsdot.wa.gov/design/accessandhearings

Access to managed access highways is regulated by the governmental entity with jurisdiction over a highway's roadsides. Access connection permits are issued on managed access highways. The Washington State Department of Transportation (WSDOT) has access connection permitting authority over all state highways outside incorporated towns and cities. Incorporated towns and cities have access connection permitting authority for city streets that are part of state highways, as specified in [Revised Code of Washington \(RCW\) 47.24.020](#). When any project is developed on a state highway outside an incorporated city or town, state law requires that existing access connections be evaluated to determine whether they are consistent with all current department spacing, location, and design standards (see [540.03](#)).

540.02 Design Considerations

Evaluate access connections by using the Access Master Plan database to identify the route classification and determine access connection requirements in conformance with this chapter or [Chapter 530](#) as appropriate. See also [Chapter 1100](#), Practical Design, and chapters in that series for guidance on how access control is used as a design control.

Review all connections and verify whether they are in the Roadway Access Management Permit System (RAMPS) database. Contact the region Development Services Office or the HQ Access and Hearings Section for permission to log on to the link through this page:

www.wsdot.wa.gov/design/accessandhearings

If a nonconforming connection is identified, consider relocating, modifying, or eliminating the connection. It is not the intent of the managed access program that modifications to the connection will change the general functionality of the property.

Where current department standards cannot be met while providing the same general functionality, classify the connection as nonconforming and process the appropriate documentation as discussed below. This documentation is part of the permit process.

540.03 Managed Access Highway Classes

The principal objective of the managed access classification system is to maintain the safety and capacity of existing highways. This is accomplished by establishing access management criteria, which are to be adhered to in the planning and regional approval of access connections to the state highway system.

The classification system for state managed access highways consists of five classes. The classes are arranged from the most restrictive, Class 1, to the least restrictive, Class 5. In general, most state highways outside the incorporated limits of a city or town have been designated as Class 1 or Class 2, with only the most urban and lowest-speed state highways within an incorporated town or city designated as Class 5. [Exhibit 540-1](#) shows the five classes of highways, with a brief description of each class. WSDOT keeps a record of the assigned managed access classifications, by state route and milepost, in the Access Control Tracking System database:

www.wsdot.wa.gov/design/accessandhearings

One of the goals of state law is to restrict or keep access connections to a minimum in order to help preserve the safety, operation, and functional integrity of the state highway. On Class 1 highways, mobility is the primary function, while on Class 5 highways, access needs have priority over mobility needs. Class 2 highways also favor mobility, while Class 3 and Class 4 highways generally achieve a balance between mobility and access.

The most notable distinction between the five highway classes is the minimum spacing requirements of access connections. [Exhibit 540-1](#) shows the minimum distances between access points on the same side of the highway. [Exhibit 540-2](#) applies to the minimum clearance from a public road or street.

In all five highway classes, access connections are to be located and designed to minimize interference with transit facilities and high-occupancy vehicle (HOV) facilities on state highways where such facilities exist or are proposed in state, regional, metropolitan, or local transportation plans. In these cases, if reasonable access is available to the local road/street

system, access is to be provided to the local road/street system rather than directly to the state highway. Following are the functional characteristics and the legal requirements for each class.

540.03(1) Class 1

540.03(1)(a) Functional Characteristics

Class 1 highways provide for high-speed and/or high-volume traffic movements for interstate, interregional, and intercity (and some intracity) travel needs. Service to abutting land is subordinate to providing service to major traffic movements.

Highways in Class 1 are typically distinguished by a highly-controlled, limited number of (public and private) access points, restrictive medians with limited median openings on multilane facilities, and infrequent intersections.

540.03(1)(b) Legal Requirements

1. It is the intent that Class 1 highways be designed to have a posted speed limit of 50 to 65 mph. Intersecting streets, roads, and highways are planned with a minimum spacing of 1 mile. Spacing of $\frac{1}{2}$ mile may be allowed, but only when no reasonable alternative access exists.
2. Private access connections to the state highway are not allowed except where the property has no other reasonable access to the local road/street system. When a private access connection must be provided, the following conditions apply:
 - The access connection continues until such time other reasonable access to a highway with a less restrictive access control class or access to the local road/street system becomes available and is allowed.
 - The minimum distance to another (public or private) access point is 1,320 feet along the same side of the highway. Nonconforming access connection permits may be issued to provide access connections to parcels whose highway frontage, topography, or location otherwise precludes issuance of a conforming access connection permit; however, variance permits are not allowed.
 - No more than one access connection may be provided to an individual parcel or to contiguous parcels under the same ownership.
 - All private access connections are for right turns only on multilane facilities. Where special conditions apply, justify the exception in a traffic analysis in the access connection permit application that is signed and sealed by a qualified professional engineer who is registered in accordance with [RCW 18.43](#).
 - Additional access connections to the state highway are not allowed for newly created parcels resulting from property divisions. All access for these parcels must be provided by an internal road/street network. Access to the state highway will be at existing permitted locations or revised locations.
3. Restrictive medians are provided on multilane facilities to separate opposing traffic movements and to prevent unauthorized turning movements.

540.03(2) Class 2

540.03(2)(a) Functional Characteristics

Class 2 highways provide for medium-to-high-speed and medium-to-high-volume traffic movements over medium and long distances for interregional, intercity, and intracity travel needs. Direct access service to abutting land is subordinate to providing service to traffic movements.

Highways in Class 2 are typically distinguished by existing or planned restrictive medians on multilane facilities and by large minimum distances between (public and private) access points.

540.03(2)(b) Legal Requirements

1. It is the intent that Class 2 highways be designed to have a posted speed limit of 35 to 50 mph in urbanized areas and 45 to 55 mph in rural areas. Intersecting streets, roads, and highways are planned with a minimum spacing of $\frac{1}{2}$ mile. Intersection spacing of less than $\frac{1}{2}$ -mile may be allowed, but only when no reasonable alternative access exists.

In urban areas and developing areas where higher volumes are present or growth that will require a change to intersection control is expected in the foreseeable future, it is imperative that the location of any public access point be planned carefully to ensure adequate traffic progression. The addition of all new public or private access points that might require signalization or other form of intersection control will require an engineering analysis that is signed and sealed by a qualified professional engineer who is registered in accordance with [RCW 18.43](#).

2. Private access connections to the state highway system are allowed only where the property has no other reasonable access to the local road/street system or where access to the local road/street system will cause unacceptable traffic operational conditions or safety concerns on that system. When a private access connection must be provided, the following conditions apply:
 - The access connection continues until such time other reasonable access to a highway with a less restrictive access control class or acceptable access to the local road/street system becomes available and is allowed.
 - The minimum distance to another (public or private) access point is 660 feet on the same side of the highway. Nonconforming access connection permits may be issued to provide access to parcels whose highway frontage, topography, or location precludes issuance of a conforming access connection permit.
 - Only one access connection is allowed for an individual parcel or to contiguous parcels under the same ownership. This applies unless the highway frontage exceeds 1,320 feet and it can be shown that the additional access connection will not adversely affect the desired function of the state highway in accordance with the assigned managed access Class 2 or the safety or operation of the state highway.
 - Variance permits may be allowed if there are special conditions and the exception can be justified to the satisfaction of the department by a traffic analysis in the

access connection permit application that is signed and sealed by a qualified professional engineer who is registered in accordance with [RCW 18.43](#).

- All private access connections are for right turns only on multilane facilities. This applies unless there are special conditions and the exception can be justified to the satisfaction of the department by a traffic analysis in the access connection permit application that is signed and sealed by a qualified professional engineer who is registered in accordance with [RCW 18.43](#) and only if left-turn channelization is provided.
 - Additional access connections to the state highway are not allowed for newly created parcels that result from property divisions. All access for these parcels must be provided by an internal road/street network. Access to the state highway will be at existing permitted locations or at revised locations.
3. On multilane facilities, restrictive medians are provided to separate opposing traffic movements and to prevent unauthorized turning movements. However, a nonrestrictive median or a two-way left-turn lane may be used where special conditions exist and main line volumes are below 20,000 average daily traffic (ADT).

540.03(3) Class 3

540.03(3)(a) Functional Characteristics

Class 3 highways provide for moderate travel speeds depending on context, and moderate traffic volumes for medium and short travel distances for intercity, intracity, and intercommunity travel needs. There is a reasonable balance between access and mobility needs for highways in this class. This class is to be used primarily where the existing level of development of the adjoining land is less intensive than maximum buildout and where the probability of significant land use change and increased traffic demand is high.

Highways in Class 3 are typically distinguished by planned restrictive medians on multilane facilities and by meeting minimum distances between (public and private) access points. Two way left-turn lanes may be used where justified and main line traffic volumes are below 25,000 ADT. Development of properties with internal road/street networks and joint access connections is encouraged.

540.03(3)(b) Legal Requirements

1. It is the intent that Class 3 highways be designed to have a posted speed limit of 30 to 40 mph in urbanized areas and 45 to 55 mph in rural areas. In rural areas, intersecting streets, roads, and highways are planned with a minimum spacing of $\frac{1}{2}$ mile. Intersection spacing of less than $\frac{1}{2}$ -mile may be allowed, but only when no reasonable alternative access exists.

In urban areas and developing areas where higher volumes are present or growth that will require a change to intersection control is expected in the foreseeable future, it is imperative that the location of any public access point be planned carefully to ensure adequate traffic progression. Where feasible, major intersecting roadways that might ultimately require signalization or other intersection control type are planned with a minimum of $\frac{1}{2}$ -mile spacing. The addition of all new public or private access points that may require signalization or other intersection control type, will require an engineering analysis

that is signed and sealed by a qualified professional engineer who is registered in accordance with [RCW 18.43](#).

2. Private Access Connections

- No more than one access connection may be provided to an individual parcel or to contiguous parcels under the same ownership. This applies unless it can be shown that additional access connections will not adversely affect the desired function of the state highway in accordance with the assigned managed access Class 3 and will not adversely affect the safety or operation of the state highway.
- The minimum distance to another (public or private) access point is 330 feet on the same side of the highway. Nonconforming access connection permits may be issued to provide access to parcels whose highway frontage, topography, or location precludes issuance of a conforming access connection permit.
- Variance permits may be allowed if there are special conditions and the exception can be justified to the satisfaction of the department by a traffic analysis in the access connection permit application that is signed and sealed by a qualified professional engineer who is registered in accordance with [RCW 18.43](#).

540.03(4) Class 4

540.03(4)(a) Functional Characteristics

Class 4 highways provide for moderate travel speeds and moderate traffic volumes for medium and short travel distances for intercity, intracity, and intercommunity travel needs. There is a reasonable balance between direct access and mobility needs for highways in this class. This class is to be used primarily where the existing level of development of the adjoining land is more intensive and where the probability of major land use changes is less than on Class 3 highway segments.

Highways in Class 4 are typically distinguished by existing or planned nonrestrictive medians. Restrictive medians may be used to mitigate unfavorable operational conditions such as turning, weaving, and crossing conflicts. Minimum access connection spacing requirements apply if adjoining properties are redeveloped.

540.03(4)(b) Legal Requirements

1. It is the intent that Class 4 highways be designed to have a posted speed limit of 30 to 35 mph in urbanized areas and 35 to 45 mph in rural areas. In rural areas, intersecting streets, roads, and highways are planned with a minimum spacing of $\frac{1}{2}$ mile. Intersection spacing of less than $\frac{1}{2}$ mile may be allowed, but only when no reasonable alternative access exists.

In urban areas and developing areas where higher volumes are present or growth that will require a change in intersection control is expected in the foreseeable future, it is imperative that the location of any public access point be planned carefully to ensure adequate traffic progression. Where feasible, major intersecting roadways that might ultimately require intersection control changes are planned with a minimum of $\frac{1}{2}$ -mile spacing. The addition of all new public or private access points that may require signalization, or other intersection control type, will require an engineering analysis that is

signed and sealed by a qualified professional engineer who is registered in accordance with [RCW 18.43](#).

2. Private Access Connections

- No more than one access connection may be provided to an individual parcel or to contiguous parcels under the same ownership. This applies unless it can be shown that additional access connections will not adversely affect the desired function of the state highway in accordance with the assigned managed access Class 4 and will not adversely affect the safety or operation of the state highway.
- The minimum distance to another (public or private) access point is 250 feet on the same side of the highway. Nonconforming access connection permits may be issued to provide access connections to parcels whose highway frontage, topography, or location precludes issuance of a conforming access connection permit.
- Variance permits may be allowed if there are special conditions and the exception can be justified to the satisfaction of the department by a traffic analysis in the access connection permit application that is signed and sealed by a qualified professional engineer who is registered in accordance with [RCW 18.43](#).

540.03(5) Class 5

540.03(5)(a) Functional Characteristics

Class 5 highways provide for moderate travel speeds and moderate traffic volumes for primarily short travel distances for intracity and intracommunity trips and for access to state highways of a higher class. Access needs generally may be higher than the need for through-traffic mobility without compromising the public's health, welfare, or safety. These highways will normally have nonrestrictive medians.

540.03(5)(b) Legal Requirements

1. It is the intent that Class 5 highways be designed to have a posted speed limit of 25 to 35 mph. In rural areas, intersecting streets, roads, and highways are planned with a minimum spacing of $\frac{1}{4}$ mile. Spacing of less than $\frac{1}{4}$ mile may be allowed where no reasonable alternative exists. In urban areas and developing areas where higher volumes are present or growth that will require changes to intersection control is expected in the foreseeable future, it is imperative that the location of any public access point be planned carefully to ensure adequate traffic progression. Where feasible, major intersecting roadways that might ultimately require changes to intersection control are planned with a minimum of $\frac{1}{4}$ mile spacing. The addition of all new public or private access points that might require signalization, or other control type, will require an engineering analysis that is signed and sealed by a qualified professional engineer who is registered in accordance with [RCW 18.43](#).
2. Private Access Connections
 - No more than one access connection may be provided to an individual parcel or to contiguous parcels under the same ownership. This applies unless it can be shown that additional access connections will not adversely affect the desired function of

the state highway in accordance with the assigned managed access Class 5 and will not adversely affect the safety or operation of the state highway.

- The minimum distance to another (public or private) access point is 125 feet on the same side of the highway. Nonconforming access connection permits may be issued to provide access to parcels whose highway frontage, topography, or location precludes issuance of a conforming access connection permit.
- Variance permits may be allowed if there are special conditions and the exception can be justified to the satisfaction of the department by a traffic analysis in the access connection permit application that is signed and sealed by a qualified professional engineer who is registered in accordance with [RCW 18.43](#).

Exhibit 540-1 Managed Access Highway Class Description

Class	Non-Conforming ^[1]	Variance ^[2]	Conforming ^[3]	Access Point Spacing**	Limitations ^[4]
Class 1 Mobility is the primary function	Yes*	No	No	1,320 ft	<ul style="list-style-type: none"> One access only to contiguous parcels under same ownership Private access connection is not allowed unless no other reasonable access exists (must use local road/street system if possible)
Class 2 Mobility is favored over access	Yes*	Yes*	No	660 ft	<ul style="list-style-type: none"> One access connection only to contiguous parcels under same ownership unless frontage > 1,320 ft Private access connection not allowed unless no other reasonable access exists; must use local road/street system if possible
Class 3 Balance between mobility and access in areas with less than maximum buildout	Yes	Yes	Yes	330 ft	<ul style="list-style-type: none"> One access connection only to contiguous parcels under same ownership Joint access connection for subdivisions preferred; private connection allowed, with justification
Class 4 Balance between mobility and access in areas with less than maximum buildout	Yes	Yes	Yes	250 ft	One access connection only to contiguous parcels under same ownership, except with justification
Class 5 Access needs may have priority over mobility	Yes	Yes	Yes	125 ft	More than one access connection per ownership, with justification

*The access connection continues only until such time other reasonable access to a highway with a less restrictive class or acceptable access to the local road/street system becomes available and is allowed.

**Minimum, on the same side of the highway.

[1] See 540.07(2).

[2] See 540.07(3).

[3] See 540.07(1).

[4] Unless grandfathered (see 540.06).

540.03(6) Changes in Managed Access Classification

WSDOT, RTPOs, MPOs, or other entities such as cities, towns, or counties may initiate a review of managed access classifications per the process identified by [WAC 468-52](#). In all cases, WSDOT consults with the RTPOs, MPOs, and local agencies and takes into consideration comments received during the review process. For city streets that are designated as state highways, the department will obtain concurrence in the final classification assignment from the city or town.

The modified highway classification list shall be submitted to Headquarters for approval by the Director & State Design Engineer, Development Division, or a designee. WSDOT regions shall notify the RTPOs, MPOs, and local governmental entities in writing of the final determination of the reclassification.

540.04 Corner Clearance Criteria

In addition to the five access control classes, there are also corner clearance criteria that must be used for access connections near intersections (see [Exhibit 540-2](#)).

Corner clearance spacing must meet or exceed the minimum access point spacing requirements of the applicable managed access highway class. A single access connection may be placed closer to the intersection, in compliance with the permit application process specified in WAC 468-51 and in accordance with the following criteria:

- The minimum corner clearance criteria in [Exhibit 540-2](#) may be used where access point spacing cannot be obtained due to property size and where a joint-use access connection cannot be secured or where it is determined by WSDOT not to be feasible because of conflicting land use or conflicting traffic volumes or operational characteristics.
- Some local agencies have adopted corner clearance as a design element in their design standards; these standards are to meet or exceed WSDOT standards. Coordinate with the local agency regarding corner clearance of an access connection on or near an intersecting local road or street.
- When a joint-use access connection or an alternate road/street system access—meeting or exceeding the minimum corner clearance requirements—becomes available, the permit holder must close the permitted access connection unless the permit holder shows to WSDOT's satisfaction that such closure is not feasible.

Exhibit 540-2 Minimum Corner Clearance: Distance From Access Connection to Public Road or Street

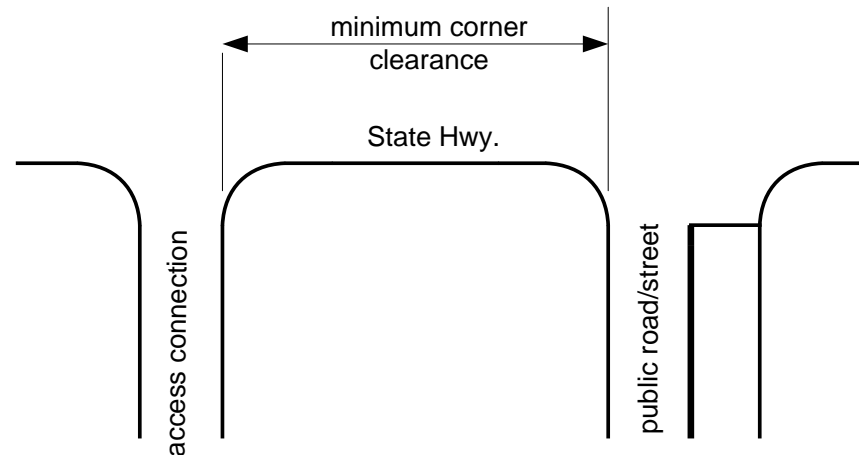

With Restrictive Median		
Position	Access Allowed	Minimum (ft)
Approaching Intersection	Right In/Right Out	115
Approaching Intersection	Right In Only	75
Departing Intersection	Right In/Right Out	230*
Departing Intersection	Right Out Only	100
Without Restrictive Median		
Position	Access Allowed	Minimum (ft)
Approaching Intersection	Full Access**	230*
Approaching Intersection	Right In Only	100
Departing Intersection	Full Access**	230*
Departing Intersection	Right Out Only	100

*125 ft may be used for Class 5 facilities with a posted speed of 35 mph or less.
 **Full Access = All four movements (Right in/Right out; Left in/Left out)

540.05 Access Connection Categories

Whenever an access connection permit is issued on a managed access state highway, the permit must also specify one of four access connection categories: Category I to Category IV. Categories I through III are based on the maximum vehicular usage of the access connection. Category IV specifies temporary use, usually for less than a year. Access connection permits must specify the category and the maximum vehicular usage of the access connection in the permit.

All access connections are determined by WSDOT to be in one of the following categories ([WAC 468-51-040](#)):

540.05(1) Category I

“Category I – minimum connection” provides connection to the state highway system for up to ten single-family residences, a duplex, or a small multifamily complex of up to ten dwelling units that use a common access connection. This category also applies to permanent access connections to agricultural and forestlands, including field entrances; access connections for the operation, maintenance, and repair of utilities; and access connections serving other low-volume traffic generators expected to have average weekday vehicle trip ends (AWDVTE) of 100 or less.

540.05(2) Category II

“Category II – minor connection” provides connection to the state highway system for medium-volume traffic generators expected to have an AWDVTE of 1,500 or less, but not included in Category I.

540.05(3) Category III

“Category III – major connection” provides connection to the state highway system for high-volume traffic generators expected to have an AWDVTE exceeding 1,500.

540.05(4) Category IV

“Category IV – temporary connection” provides a temporary, time-limited connection to the state highway system for a specific property for a specific use with a specific traffic volume. Such uses include, but are not limited to, logging, forestland clearing, temporary agricultural uses, temporary construction, and temporary emergency access. The department reserves the right to remove any temporary access connection at its sole discretion and at the expense of the property owner after the expiration of the permit. Further, a temporary access connection permit does not bind the department, in any way, to the future issuance of a permanent access connection permit at the temporary access connection location.

540.06 Access Connection Permit

[RCW 47.50](#) requires all access connections to be permitted. This can be accomplished by the permitting process (see [540.07](#)) or by the connection being “grandfathered” (in place prior to July 1, 1990).

All new access connections to state highways, as well as alterations and improvements to existing access connections, require an access connection permit. Every owner of property that abuts a managed access state highway has the right to reasonable access, but not a particular means of access. This right may be restricted with respect to the highway if reasonable access can be provided by way of another local road/street.

When a new private road or street is to be constructed, approval by the permitting authority is required for intersection design, spacing, and construction work on the right of way. However, if an access connection permit is issued, it will be rendered null and void if and when the road or street is duly established as a local road or street by the local governmental entity.

It is the responsibility of the applicant or permit holder to obtain all necessary local, state, and federal approvals and permits (which includes all environmental permits and documentation).

The access connection permit only allows the applicant permission to connect to the state highway. It is also the responsibility of the applicant to acquire any and all property rights necessary to provide continuity from the applicant's property to the state highway.

The alteration or closure of any existing access connection caused by changes to the character, intensity of development, or use of the property served by the access connection or the construction of any new access connection must not begin before an approved access connection permit is obtained.

If a property owner or permit holder with a valid access connection permit wishes to change the character, use, or intensity of the property or development served by the access connection, the permitting authority must be contacted to determine whether an upgraded access connection permit will be required.

540.07 Permitting and Design Documentation

An access connection permit is obtained from the department by submitting the appropriate application form, including the fee, plans, traffic data, and access connection information, to the department for review. All access connection and roadway design documents for Category II and III permits must bear the seal and signature of a professional engineer registered in Washington State.

The permitting process begins with the application. Upon submittal of the application with all the attached requirements, it is reviewed and either denied or accepted. If denied, the department must notify the applicant in writing stating the reasons, and the applicant will have thirty (30) days to submit a revised application. Once the application is approved and the permit is issued, the applicant may begin construction.

The Access Manager in each region keeps a record of all access points, including those that are permitted and those that are grandfathered (see [540.08](#)). A permit for a grandfathered access point is not required but may be issued for recordkeeping reasons.

540.07(1) Conforming Access Connection Permit

Conforming access connection permits may be issued for access connections that conform to the functional characteristics and all legal requirements for the designated class of the highway.

540.07(2) Nonconforming Access Connection Permit

Nonconforming access connection permits may be issued:

- For short-term access connections pending the availability of a future joint-use access connection or local road/street system access.
- For location and spacing not meeting requirements.
- For Category I through IV permits.
- After an analysis and determination by the department that a conforming access connection cannot be made at the time of permit application submittal.
- After a finding that the denial of an access connection will leave the property without a reasonable means of access to the local road/street system.

In such instances, the permit is to be noted as being a nonconforming access connection permit and may contain the following specific restrictions and provisions:

- Limits on the maximum vehicular use of the access connection.
- The future availability of alternate means of reasonable access for which a conforming access connection permit can be obtained.
- The removal of the nonconforming access connection at the time the conforming access is available.
- The properties to be served by the access connection.
- Other conditions as necessary to carry out the provisions of [RCW 47.50](#).

540.07(3) Variance Access Connection Permit

Variance access connection is a special nonconforming or additional access connection permit issued for long-term use where future local road/street system access is not foreseeable:

- For location and spacing not meeting requirements or for an access connection that exceeds the number allowed for the class.
- After an engineering study demonstrates, to the satisfaction of the department, that the access connection will not adversely affect the safety, maintenance, or operation of the highway in accordance with its assigned managed access class.

In such instances, the permit is to be noted as being a variance access connection permit and may contain the following specific restrictions and provisions:

- Limits on the maximum vehicular use of the access connection
- The properties to be served by the access connection
- Other conditions as necessary to carry out the provisions of [RCW 47.50](#)

This permit will remain valid until modified or revoked by the permitting authority unless an upgraded permit is required due to changes in property site use (see [540.08\(1\)](#)).

A variance access connection permit must not be issued for an access connection that does not conform to minimum corner clearance requirements (see [540.04](#)).

540.07(4) Corner Clearance Design Analysis

540.07(4)(a) Outside Incorporated City Limits

A design analysis request will be required for nonconforming access connections if corner clearance criteria are not met. The ASDE should be involved early in the process. Such an access will be outside the corner radius and as close as feasible to the property line farthest away from the intersection.

An exception to the above may be allowed for a single-family residence, serving a single residence, not meeting the minimum corner clearance criteria and having no feasible connection to the local cross street. One single family home generates a very low volume of traffic and will pose a low conflict potential for traffic on the State Highway System. A single-family access connection exception is to comply with the following criteria:

- Serves a single residence
- Access is to be outside the corner radius
- Access is to be located as close as feasible to the property line farthest away from the intersection
- The denial of an access connection would leave the property without a reasonable means of access.
- The connection is to be relocated to a local road/street system, if one becomes available.

Document the above criteria in the access connection permit.

540.07(4)(b) Within Incorporated Cities

In accordance with [RCW 35.78.030](#) and [RCW 47.50](#), incorporated cities and towns have jurisdiction over access permitting on streets designated as state highways and, therefore, no design analysis by WSDOT will be required. On WSDOT projects, document decisions made on these accesses in the DDP.

540.08 Other Considerations

540.08(1) Changes in Property Site Use With Permitted Access Connection

The access connection permit is issued to the permit holder for a particular type of land use generating specific projected traffic volumes at the final stage of proposed development. Any changes made in the use, intensity of development, type of traffic, or traffic flow require the permit holder, an assignee, or the property owner to contact the department to determine whether further analysis is needed because the change is significant and will require a new permit and modifications to the access connection ([WAC 468-51-110](#)).

A significant change is one that will cause a change in the category of the access connection permit or one that causes an operational, safety, or maintenance problem on the state highway system based on objective engineering criteria or available collision data. Such data will be provided to the property owner and/or permit holder and tenant upon written request ([WAC 468-51-110](#)).

540.08(2) Existing Access Connections

540.08(2)(a) Closure of Grandfathered Access Connections

Any access connections that were in existence and in active use on July 1, 1990, are grandfathered.

The grandfathered access connection may continue unless:

- There are changes from the 1990 AWDVTE.
- There are changes from the 1990 established use.
- The department determines that the access connection does not provide minimum acceptable levels of highway safety and mobility based on collision and/or traffic data

or accepted traffic engineering criteria, a copy of which must be provided to the property owner, permit holder, and/or tenant upon written request ([WAC 468-51-130](#)).

540.08(2)(b) Department Construction Projects

540.08(2)(b)(1) Notification

The department must notify affected property owners, permit holders, business owners, and emergency services in writing, when appropriate, whenever the department's work program requires the modification, relocation, or replacement of its access connections. In addition to written notification, the department will facilitate, when appropriate, a process that may include, but is not limited to, public notices, meetings, or hearings, as well as individual meetings.

540.08(2)(b)(2) Modification Considerations

When the number, location, or design of existing access connections to the state highway is being modified by a department construction project, the resulting modified access connections must provide the same general functionality for the existing property use as they did before the modification, taking into consideration the existing site design, normal vehicle types, and traffic circulation requirements. These are evaluated on an individual basis.

It is important to remember that the intent is not to damage the property owner by removing nonconforming access connections, but to eliminate access connections that are both nonconforming and not needed.

The permitting authority evaluates each property individually to make a determination about which category of access connection (see [540.05](#)) and which design template (see [Chapter 1340](#)) will be reasonable. If it is a commercial parcel, determine whether the business can function with one access connection. Each parcel, or contiguous parcels under the same ownership being used for the same purpose, is allowed only one access connection. If the business cannot function properly with only one access connection, a variance permit may be issued for additional access connections. If the property is residential, only one access connection is allowed; however, certain circumstances might require an additional access connection (see [540.07\(4\)\(a\)](#)).

540.08(2)(b)(3) Costs: Replacement of/Modifications to Existing Access Connections

The costs of modifying or replacing the access points are borne by the department if the department construction project caused the replacement or modification. Modification of the connection may require a change to the existing permit.

540.08(3) Work by Permit Holder's Contractor

The department requires that work by the owner's contractor be accomplished at the completion of the department's contract or be scheduled so as not to interfere with the department's contractor. The department may require a surety bond prior to construction of the access connection in accordance with [WAC 468-51-070](#).

540.09 Preconstruction Conference

All new access connections, including alterations and improvements to existing access connections to the highway, require an access connection permit. The permitting authority may require a preconstruction conference prior to any work being performed on the access. The preconstruction conference must be attended by those necessary to ensure compliance with the terms and provisions of the permit. Details regarding the individual access connections will be included in the construction permit. This may include access connection widths, drainage requirements, surfacing requirements, mailbox locations, and other information ([WAC 468-51-090](#)).

540.10 Adjudicative Proceedings

Any person who can challenge any of the following departmental actions may request an adjudicative proceeding (an appeal to an Administrative Law Judge) within thirty (30) days of the department's written decision ([WAC 468-51-150](#)):

- Denial of an access connection permit application pursuant to [WAC 468-51-080](#)
- Permit conditions pursuant to [WAC 468-51-150](#)
- Permit modifications pursuant to [WAC 468-51-120](#)
- Permit revocation pursuant to [WAC 468-51-120](#)
- Closure of permitted access connection pursuant to [WAC 468-51-120](#)
- Closure of grandfathered access connection pursuant to [WAC 468-51-130](#)

An appeal of a decision by the department can be requested only if the administrative fee has been paid. If the fee has not been paid, the permit application is considered incomplete and an adjudicative proceeding cannot be requested.

540.10(1)(a) Adjudicative Proceedings Process

Following is a brief summary of the adjudicative proceeding process. For the purpose of this summary, the responsibilities of the department are separated into those actions required of the region and those actions required of Headquarters. The summary is written as if the appealable condition was a denial of an access connection request.

1. The region receives an access connection permit application, with fee.
2. The region processes the application and makes a determination that the access connection request will be denied.
3. The region sends the applicant a written letter denying the access connection. Included in this letter is notification that the applicant has thirty (30) days to request an adjudicative proceeding if the applicant disagrees with the region's denial decision. The region must notify affected property owners, permit holders, business owners, tenants, lessees, and emergency services, as appropriate.
4. The applicant requests, within thirty (30) days, an adjudicative proceeding.
5. The region reviews its initial denial decision and determines whether there is any additional information presented that justifies reversing the original decision.

6. If the region determines that the original denial decision will stand, the region then forwards copies of all applicable permit documentation to the HQ Development Services & Access Manager for review and processing.
7. The HQ Development Services & Access Manager reviews the permit application and sends the permit documentation and appeal request to the Office of the Attorney General (AG).
8. If the initial findings of the AG agree with the region's denial decision, the AG's Office sends the applicant a written letter, with the AG's signature, informing the applicant that a hearing will be scheduled for the applicant to appeal in person the department's decision to deny access.
9. The region reserves a location and obtains a court reporter, and Headquarters obtains an Administrative Law Judge (ALJ) to conduct the proceeding. The AG, by written letter, notifies the applicant of the time and place for the hearing. The AG's Office has ninety (90) days from receipt of the applicant's appeal to approve or deny the appeal application, schedule a hearing, or decide not to conduct a hearing. The actual hearing date can be set beyond this ninety-day (90-day) review period.
10. The AG's Office leads the department's presentation and works with the region regarding who will testify and what displays and other information will be presented to the ALJ. The HQ Development Services & Access Manager will typically not attend these proceedings.
11. After hearing all the facts, the ALJ issues a decision, usually within a few weeks after the proceedings. However, the ALJ has ninety (90) days in which to serve a written Initial Order stating the decision.
12. The ALJ's decision is final unless the applicant, or the department through the HQ Development Services & Access Manager, decides to appeal the ALJ's decision to the Director & State Design Engineer, Development Division. This second appeal must occur within twenty (20) days of the ALJ's written decision.
13. If appealed to the Director & State Design Engineer, Development Division, the Director & State Design Engineer has ninety (90) days to review the Initial Order and all the facts and supporting documentation and issue a Final Order. The review by the Director & State Design Engineer does not require the applicable parties to be present and may involve only a review of the material submitted at the adjudicative proceeding.
14. The Director & State Design Engineer's decision is final unless appealed within thirty (30) days to the Washington State Superior Court.

The above represents a general timeline if all appeals are pursued. Based on the noted timelines, it can take nearly a year before a Final Order is issued. If appealed to Superior Court, up to an additional 18 months can be added to the process. In any case, contact the region Development Services Engineer for further guidance and direction if an appeal might be forthcoming.

540.11 Documentation

Refer to [Chapter 300](#) for design documentation requirements.

540.12 References

540.12(1) *State Laws and Codes*

[Chapter 520](#), Access Control, provides reference to laws and codes

540.12(2) *Design Guidance*

[Chapter 520](#), Access Control

Chapters in the [1100](#) series for guidance on practical design, context, and design controls

[Chapter 1230](#), Geometric Cross Section

Chapters [1300](#) and [1310](#), for intersection design policy and guidance

[Chapter 1340](#), Driveways

[Chapter 1600](#), Roadside Safety

- 1105.01 [General](#)
- 1105.02 [Selecting Design Elements](#)
- 1105.03 [Related Elements](#)
- 1105.04 [Documentation](#)
- 1105.05 [References](#)

1105.01 General

Design elements are specific components associated with roadway design, such as lane widths, shoulder widths, alignments, clear zone, etc. Design controls (see [Chapter 1103](#)) are carefully chosen and used to determine the dimensions of design elements. The relative effect that a given design element will have on performance will depend on the selected design controls and context identification. For more information, see the guidance document section titled [The Research Summary of Different Design Elements on Performance](#).

1105.02 Selecting Design Elements

Design elements that are included in a project are documented in the [Basis of Design](#). Include the design elements that are changed by the project. (See [Chapter 1100](#) for more information about Basis of Design.)

An element is **changed** if one of the following applies:

- A new element is added
- An existing element is removed or relocated
- A dimension - such as a width - is modified

A design element that is **not changed** is not documented in the Basis of Design.

The next step after selecting design elements is to choose the appropriate dimension for each element. (See [Chapter 1106](#) for information on selecting design element dimensions.)

1105.02(1) *Required Design Elements and Criteria*

There are also additional legal and policy-based considerations that require a decision of whether or not to include certain design elements in a project; this depends on the program or sub-program. See [Exhibit 1105-1](#) for additional information regarding whether or not to include these design elements in a project.

Exhibit 1105-1 Required Design Elements

Program or Sub-Program	Design Elements						
	ADA	Clear Zone [1]	Roadside Safety Hardware [3]	Signing & Delineation [4]	Illumination [7]	ITS [8]	Signal Hardware
I-1 Mobility I-3 Economic Initiative - Trunk System I-6 Sound Transit	Apply the content in Chapter 1510 (1510.05)	Apply the content in Chapter 1600	Apply the content in Chapters 1600 , 1610 and 1620	Apply the content in Chapter 1020 for signing and Chapter 1030 for delineation	Apply the content in Chapter 1040	Apply the content in Chapter 1050	[5]
All Preservation (P-1, P-2, P-3)	Apply the content in Chapter 1120 (1120.03(2))	[2]	Apply the content in Chapter 1120	[2] [6]	[2]	[2]	[5]
I-2 Safety I-4 Environmental Retrofit I-3 All Other	Apply the content in Chapter 1510 (1510.05)	[2]	[2]	[2] [6]	[2]	[2]	[5]

Notes:

- [1] See [Chapter 1600](#)
- [2] Only include when changed as described in [1105.02](#).
- [3] Includes all roadside safety design elements in Chapters [1600](#), [1610](#), and [1620](#).
- [4] See [Chapter 1020](#) for signing and [Chapter 1030](#) for delineation
- [5] Consult the Assistant State Design Engineer (ASDE), HQ Traffic Office, and Capital Program Development and Management Office (CPDM) to determine policy requirements.
- [6] Consult the ASDE for policy requirements if the roadway channelization is changed.
- [7] See [Chapter 1040](#)
- [8] See [Chapter 1050](#)

1105.03 Related Elements

Design elements can be interrelated. Even if a specific design element has not changed in accordance with the definition in [1105.02](#), consider whether or not the preferred alternative has changed the conditions in a way that may affect the performance of an unchanged element, considering all modes.

Example: A project team proposes to provide a left-turn lane along a portion of their project in order to address a baseline need related to safety for turning traffic, by reducing the width of each highway shoulder. By reducing the shoulder width, the traveled way will be closer to the roadside than in the existing condition. The project team determines whether the project would adversely affect safety performance due to roadside conditions such as steep slopes or objects in the clear zone along with considering impacts to bike and pedestrian use.

1105.04 Documentation

Document design elements that are changed in Section 5 of the [Basis of Design](#) (BOD) form unless the exemptions listed in [1100.10\(1\)](#) apply.

As a design alternative matures over time, it is likely that design elements may be added or dropped through the iterative process inherent with design. It is important to update the Basis of Design documentation with these changes at the various documentation and approval milestones.

The Basis of Design is available to download here:

 www.wsdot.wa.gov/Design/Support.htm

1105.05 References

The Research Summary of Different Design Elements on Performance, WSDOT Guidance Document:

 www.wsdot.wa.gov/Design/Support.htm

- [1120.01 General](#)
- [1120.02 Structures Preservation \(P2\) and Other Facilities \(P3\)](#)
- [1120.03 Roadway Preservation \(P1\)](#)
- [1120.04 Documentation](#)

1120.01 General

This chapter provides information specific to preservation project types.

This chapter identifies those elements and features to be evaluated and potentially addressed during the course of a preservation project. The elements listed here may be in addition to the project need identified in the Project Summary or Basis of Design (see [1120.03\(8\)](#)). Preservation projects may also provide opportunities for project partnering and retrofit options involving additional elements (for example see [1231.06](#)).

Preservation projects are funded in three sub-program areas:

- **Roadway Preservation (P1) projects** preserve pavement structure, extend pavement service life, and restore the roadway for reasonably safe operations of the travel modes accommodated by the facility.
- **Structures Preservation (P2) projects** preserve the state's bridge network through cost-effective actions. There are numerous types of bridge preservation actions including: deck rehabilitation, seismic retrofit, painting steel bridges, scour repair, and others.
- **Other Facilities (P3) projects** preserve the function of guardrail and signing, major drainage, major electrical, unstable slopes and other assets.

For required design elements in these programs see [Exhibit 1105-1](#).

For more information on these programs see the Planning & Programming – Scoping website:
<http://wwwi.wsdot.wa.gov/Planning/CPDMO/PlanProgScoping.htm>

1120.02 Structures Preservation (P2) and Other Facilities (P3)

For Structures Preservation (P2) and Other Facilities (P3) projects see the scoping instructions specific to the sub-program and type of work to determine the likely design elements to be addressed by the project.

See [Chapter 300](#) for documentation requirements. If the project changes a geometric design element, replaces an existing bridge or installs a new bridge additional documentation may be required; contact your ASDE to discuss appropriate documentation.

1120.03 Roadway Preservation (P1)

This section applies to features and design elements to be addressed on Roadway Preservation (P1) projects. See [1120.03\(8\)](#) for instructions on using the Basis of Design to document design elements that are changed by the project.

1120.03(1) Adjust existing features

- Adjust existing features such as monuments, catch basins, and access covers that are affected by resurfacing.
- Evaluate drainage grates and gutter pans, and adjust or replace as needed to address bicycle safety (see Drainage Grates and Manhole Covers in [Chapter 1520](#)).
- For guidance on existing curb see [Chapter 1239](#).
- Replace rumble strips if they are removed through project actions, or if their average depth is less than 3/8", unless there is a documented justification for their removal (see [Chapter 1600](#)).

1120.03(2) ADA requirements

- Address ADA requirements according to WSDOT policy (see [Chapter 1510](#) and any active project delivery memorandums or design memorandums).

1120.03(3) Cross slope lane

- Rebuild the cross slope to a minimum 1.5% when the existing cross slope is flatter than 1.5% and the steeper slope is needed to provide adequate highway runoff. See [Chapter 1250](#) for more information about cross slope.

1120.03(4) Cross slope shoulder

- When rebuilding the lane cross slope, evaluate shoulder cross slope in accordance with [Chapter 1250](#).

1120.03(5) Vertical clearance

- Paving projects, and seismic retrofit projects, may impact vertical clearances (see [Chapter 720](#) for bridge clearances and [Chapter 1020](#) for overhead sign assemblies.)
- If vertical clearance will be changed by the project, evaluate this in accordance with [Chapter 720](#). Include this design element and any other affected geometrics in the Basis of Design, the Design Parameters sheets and the Design Documentation Package.
- Contact the Commercial Vehicle Services Office when changes to vertical clearance are planned.

1120.03(6) Delineation

- Install and replace delineation in accordance with [Chapter 1030](#) (this includes pavement markings, guideposts, and barrier delineation).

1120.03(7) **Barriers and terminals**

- When the preservation project design, other than a chip seal or BST, will affect the elevation of the pavement adjacent to a guardrail, terminal, and/or transition, measure the height of those systems within the project limit and adjacent to pavement edges, curbs, or sidewalks prior to construction. Measure the height to the top of the rail element from the outside paved shoulder edge when no curb is present, from the gutter line when guardrail is set above a curb, or from the sidewalk elevation if set behind a sidewalk. Guidance for this situation:
 - When the height of Type 1 guardrail, terminals, and/or transitions will be outside the height range from 26.5" to 31" after the project is finished; the guardrail, terminals, and/or transitions must be adjusted to a minimum height of 28" up to a maximum height of 31". Guardrail posts cannot be raised. See Section 1610.04(4) for acceptable options for raising the rail. Otherwise replace with a Type 31 guardrail system.
 - When the height of Type 31 guardrail, terminals, and/or transitions will be outside the height range from 28" to 32" after the project is finished; the guardrail, terminals, and/or transitions must be adjusted to a height of 31". Guardrail posts cannot be raised. See Section 1610.04(4) for acceptable options for raising the rail. Otherwise replace.
 - When terminals need to be raised, replace them with crash worthy terminals. Provide replacement terminals in accordance with 1610.04(5)(a or b). Terminals and anchors that are effectively shielded by another barrier are not in the Design Clear Zone, and thus do **not warrant** replacement.
 - When guardrail needs to be raised, evaluate the guardrail length of need in accordance with Chapter 1610. Notify Region Program Management if the length of need extension is longer will be longer than 250 feet. Extending length of need further than 250 feet is beyond the scope of the pavement preservation.
 - Note that removal is an option if guardrail is no longer needed based on the guidance in Chapters 1600 and 1610. Document the location of removal and the reasoning for removal in the Design Documentation Package.
 - When adjusting terminals that are equipped with CRT posts, the top-drilled holes in the posts need to be at the surface of the ground.
 - Pre-cast concrete barrier sections (either New Jersey or "F" shape) are normally installed at a 32" height, which includes provision for up to a 3" overlay. A 29" minimum height for this type of barrier must be maintained following an overlay.
 - Single slope concrete barrier may be pre-cast or cast in place, and is installed new at a height of 42", 48", or 54". A 30" minimum height must be maintained for this type of barrier following an overlay.

1120.03(8) Pavement Edge Treatment

Adding a pavement edge treatment is a low-cost feature to improve safety performance for errant vehicles that depart and try to reenter the roadway. A pavement edge treatment can also help maintain the structural integrity of the roadway and pavement performance at the edge of the roadway by resisting the start of pavement cracking and/or pavement raveling.

Where practicable, install a pavement edge treatment at locations where asphalt concrete pavement is applied to the outside edge of the existing pavement. Examples where pavement edge treatment may not be practicable include, locations with roadside barrier and/or curb. After installing the pavement edge treatment, trim shoulders with material that is graded back over the edge treatment and flush with the paved roadway surface.

- For more information about pavement edge treatment, contact the HQ Design Office, and visit the FHWA website at:

<https://www.fhwa.dot.gov/innovation/everydaycounts/edc-1/safetyedge.cfm>

1120.04 Documentation

For Roadway Preservation (P1) projects, use the Basis of Design to document decisions when the project changes any design elements that are not listed in [1120.03\(1\)](#) through [1120.03\(7\)](#). Document any changes to dimensions on the Design Parameter Sheets.

- 1320.01 General
- 1320.02 Roundabout Types
- 1320.03 Capacity Analysis
- 1320.04 Geometric Design
- 1320.05 Pedestrians
- 1320.06 Bicycles
- 1320.07 Signing
- 1320.08 Pavement Marking
- 1320.09 Illumination
- 1320.10 Road Approach, Parking, and Transit Facilities
- 1320.11 Geometric Design Peer Review
- 1320.12 Documentation and Approvals
- 1320.13 References

1320.01 General

Modern roundabouts are near-circular intersections at grade. They are an effective intersection type with fewer conflict points and lower speeds, and they provide for easier decision making than other intersection types. They also require less maintenance than traffic signals. Well-designed roundabouts have been found to reduce crashes (especially fatal and severe injury collisions), traffic delays, fuel consumption, and air pollution. They also have a traffic-calming effect by reducing vehicle speeds using geometric design rather than relying solely on traffic control devices.

Roundabout design is an iterative process.

A well-designed roundabout achieves a balance of safety and efficiency.

Good design is a process of creating the smooth curvature, channelization, and deflection required to achieve consistent speeds, well-marked lane paths, and appropriate sight distance.



Roundabout

The decision to install a roundabout is the result of an Intersection Control Evaluation (ICE) (see Chapter 1300) approved by the region Traffic Engineer or other designated authority.

1320.02 Roundabout Types

There are five basic roundabout types: mini, compact, single-lane, multilane, and teardrop described in the following sections.

1320.02(1) Mini-Roundabouts

Mini-roundabouts are small single-lane roundabouts generally used in 25 mph or less urban/suburban environments. Because of this, mini-roundabouts are typically not suitable for use on higher-volume (greater than 6,000 AADT) state routes. In retrofit applications, mini-roundabouts are relatively inexpensive because they normally require minimal additional pavement at the intersecting roads. A 2-inch mountable curb for the splitter islands and the central island is desirable because larger vehicles might be required to cross over it.

A common application is to replace a stop-controlled or uncontrolled intersection with a mini-roundabout to reduce delay and increase capacity. With mini roundabouts, the existing curb and sidewalk at the intersection can sometimes be left in place.

1320.02(2) Compact Roundabouts

Compact roundabouts are a hybrid of attributes found in mini- and single-lane roundabouts. Similar to a mini-roundabout, a compact roundabout may require minimal additional pavement, has a completely mountable center island, and in many cases existing curb or sidewalk can be left in place. As a result, compact roundabouts rarely require the purchase of right of way. Compact roundabouts are similar to single-lane roundabouts regarding design vehicle assumptions, ability to process traffic volumes, and signing.



Compact roundabouts



1320.02(2) *Single-Lane Roundabouts*

Single-lane roundabouts have single-lane entries at all legs and one circulating lane. They typically have mountable raised splitter islands, a mountable truck apron, and a landscaped central island.



Single-lane roundabout

1320.02(3) *Multilane Roundabouts*

Multilane roundabouts have at least one entry or exit with two or more lanes and more than one circulating lane. The operational practice for trucks negotiating roundabouts is to straddle adjacent lanes.



Multilane roundabout

1320.02(4) *Teardrop Roundabout*

Teardrops are usually associated with ramp terminals at interchanges: typically, at diamond interchanges. Teardrop roundabouts allow the “wide node, narrow link” concept. Unlike circular roundabouts, teardrops do not allow for continuous 360° travel resulting in less vehicle conflicts as traffic traveling on the crossroad (link) between ramp terminal intersections (nodes) does not encounter a yield as it enters the teardrop intersections. At higher ADT locations this lack of conflicting vehicles can result in a higher throughput, but can also result in limited gaps for the off ramp approach. Consult HQ or region Traffic Office for guidance.



Teardrop roundabouts

1320.03 Capacity Analysis

Use the capacity analysis completed as part of the Intersection Control Evaluation (see [Chapter 1300](#)) to verify the number of lanes required for every individual movement in the design year.

1320.04 Geometric Design

1320.04(1) *Selecting Shape and Placement*

Roundabout shape is an important decision, because the shape can affect design elements that affect safety performance and operation of the roundabout.

1320.04(1)(a) **Circular**

The circular shape is the most desirable roundabout shape when constraints allow. If a circular shape is not feasible, contact the region Traffic Office to investigate other shapes described below. Sometimes a circular shape can be used by slightly offsetting the placement of the roundabout.



Circular shape

1320.04(1)(b) Non-Circular

A non-circular roundabout is a good choice when constraints such as right of way, existing roadway alignments, buildings, and/or environmentally sensitive areas influence the shape.

Experiment with different roundabout sizes and radii, and use design vehicle turning software (such as AutoTURN®) to refine the shape to find the best operation while retaining desired speeds.

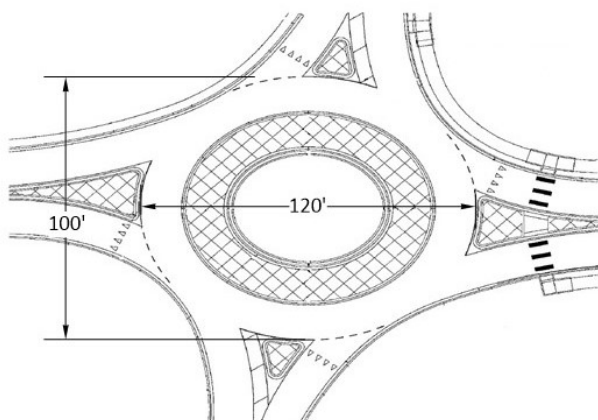

*Non-circular roundabout
with example dimensions*

1320.04(2) Roundabout Design Elements

This section provides guidance for roundabout design elements. The photo below labels many of them.

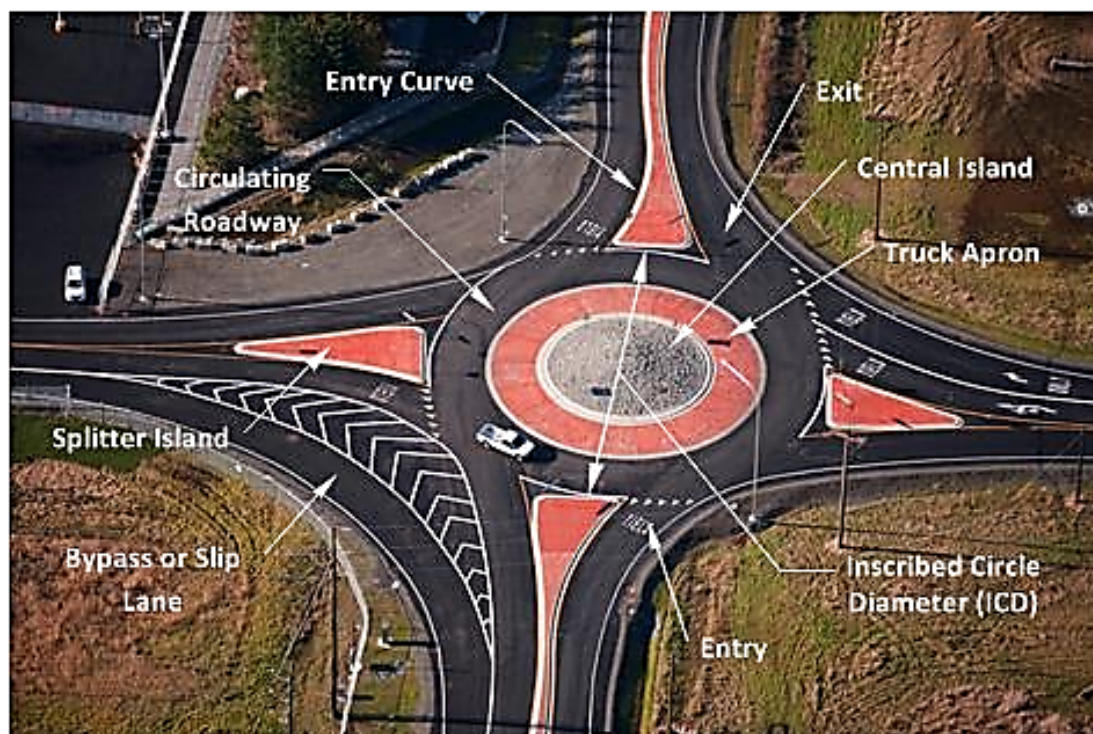

Roundabout design elements

1320.04(2)(a) Curbing

All curbing within a roundabout should be rolled. The type of rolled curbing appropriate for a roundabout is shown in the Standard Plan Roundabout Cement Concrete Curbs: F-10.18.

Exception: existing curb untouched as part of a mini or compact roundabout installation may remain.

1320.04(2)(b) Truck Apron

A truck apron is the mountable portion of the central island used to accommodate the turning path of a design vehicle larger than a passenger vehicle or BUS, and helps to minimize the overall footprint of the roundabout. Generally, the truck tractor can traverse the roundabout in the circulating lane while the trailer is allowed to off track onto the apron. The apron is raised above the circulating path to provide guidance for drivers in the circulating lane.

A truck apron's width is based on the needs of the design vehicle. If buses are a consistent vehicle using the intersection try to minimize apron use for all movements, however this is not a requirement. Use turn simulation software (such as AutoTURN®) to fine tune the width of apron needed, so as not to design an apron that won't be used.

The apron color should be easily distinguishable in contrast with the adjacent circulating roadway and pedestrian facilities. Work with the region Landscape Architect (HQ Roadside and Site Development Section for regions without a Landscape Architect) for concrete color and texture.



Roundabout showing colored truck apron at central island and at buffer area between travel lanes and sidewalk

1320.04(2)(c) Central Island

The central island is the portion of the roundabout that is inside of the circulating roadway and typically includes an inside truck apron and a landscaped area (except for mini-roundabouts and compact roundabouts, which have no landscaped area and are entirely mountable).

Central island shape is a function of the site-specific needs of a roundabout intersection. It doesn't have to be an identical shape of the inscribed circle diameter (ICD) dimensions, but

should support the design principles of deflection and low speeds, and the accommodation of the design vehicle.

Roundabouts present opportunities to create community focal points, landscaping, and other gateway features within an intersection. The central island may include enhancements (such as landscaping, sculptures, or fountains), which serve both an aesthetic purpose and provide visual indication of the intersection for approaching motorists (this is particularly important for high speed approaches). Ideal central island treatments fit the context and result in minimal consequence to any vehicle that may encroach on the non-mountable portion of the central island. These treatments should not attract pedestrians to the central island, as pedestrians should never cross the circulating roadway. Work with the region Landscape Architect (HQ Roadside and Site Development Section for regions without a Landscape Architect) for central island features. See [Chapter 950](#) Public Art for policy and guidance.

1320.04(2)(d) Splitter Island

A splitter island is the raised island at each two-way leg between entering and exiting vehicles, designed primarily to control the entry and exit speeds by providing deflection. They also discourage wrong-way movements, and provide pedestrian refuge. Splitter islands can have different shapes based on entry angle requirements and exit design speeds.

Raised channelization, or the appearance of raised curbing, is important, as research shows that drivers will slow down when they perceive that the driving width is narrowing.

The length of the splitter island will vary (typical lengths: 30 ft. to 350 ft.) based on the terrain, access considerations, site-specific mainline and crossroad operational speeds and the stepdown speeds to the final desired entry speed, which is usually 15–25 mph. (See [1320.04\(3\)\(a\)](#) for using chicanes on higher-speed roadways.)

Try to maximize the splitter island width adjacent to the circulating roadway. The larger achieved width, the better a driver approaching the roundabout can perceive whether a driver in the circulating lane will exit or continue inside the roundabout. This results in better gap acceptance. This may also support a better pedestrian refuge design.

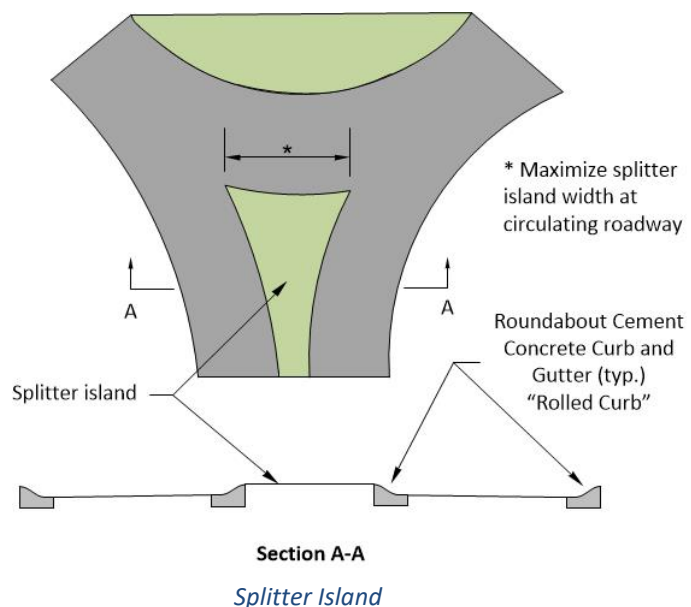

1320.04(2)(e) Inscribed Circle Diameter (ICD)

The Inscribed Circle Diameter (ICD), that is, the overall outside diameter of a roundabout, is determined by the variables design vehicle, design speed, and the number of circulatory lanes.

The ranges of ICD in Exhibit 1320-1 are only suggestions to start a roundabout design. The ICD for noncircular shapes should be defined with dimensions along the X and Y axis.

Exhibit 1320-1 Suggested Initial Design Ranges

Design Element	Mini ^[1]	Compact	Single-Lane	Multilane
Number of Lanes	1	1+	1	2+
Inscribed Circle Diameter ^[2]	45' – 80'	65' – 120'	80' – 150'	120' – 165'
Circulating Roadway Width	N/A	N/A	14' – 19'	29'
Entry Widths	N/A	N/A	16' – 18'	25'
<p>Notes: The “+” symbol used here means that a portion of the circulating roadway may have more than one lane. [1] Reserved for urban/suburban intersections with a 25 mph or less posted speed. [2] The given diameters assume a circular roundabout; adjust accordingly for other shapes. Some conditions may require ICDs outside ranges shown here.</p>				

1320.04(2)(f) Entry

1. Deflection

Ideal alignment offers an entry design that provides deflection, speed control, and reasonable view angles to drivers while balancing property impacts and costs. While most intersections are at 90° angles and most through movements are straight, deflection contributes to the safety performance of a roundabout. Deflection is primarily achieved with the central island and supporting it with splitter islands on all entries to the roundabout.

2. Alignment Offset

There are three alignment choices for attaching entry legs to the circulatory roadway:

- The offset left alignment is preferred. It constrains the entry, slowing a vehicle's approach speed, and opens up the exit for efficient egress.
- The symmetrical alignment (if needed) is acceptable for lower speed contexts such as 30 mph.
- The offset right alignment tends to allow faster entry speeds and constrains the exit; it is undesirable.

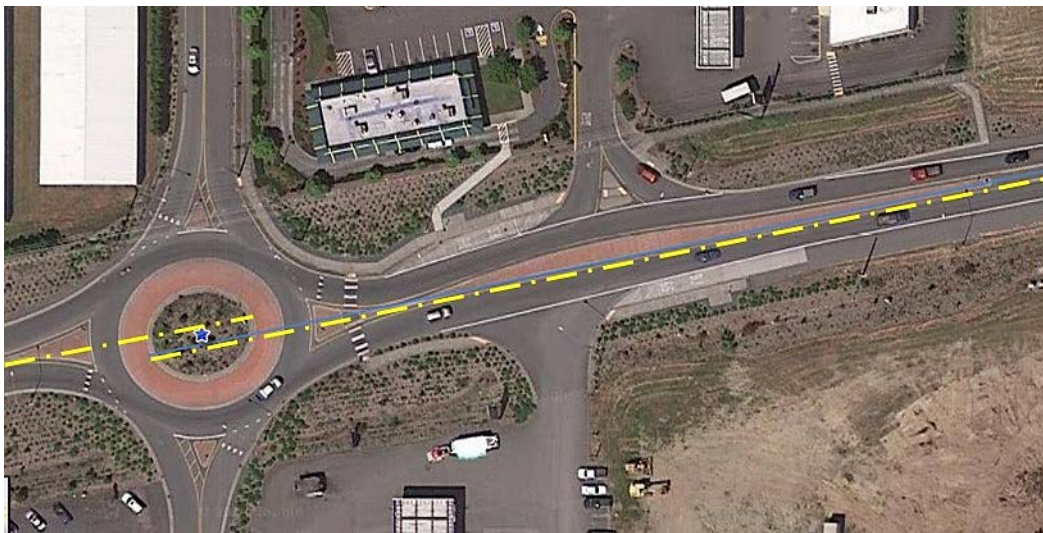

Offset left alignment (preferred)

3. Entry Angle

To achieve the proper amount of deflection for each approach to a roundabout, there is a range of angle values that are desirable. This range is usually between 20 and 40 degrees. The purpose of entry angle is so vehicles don't hit broadside.

4. Entry Width

Entry width is determined by the turning template of the design vehicle turning through the entry curve at the desired entry speed. The ranges of entry widths in [Exhibit 1320-1](#) are only suggestions to start a roundabout design.

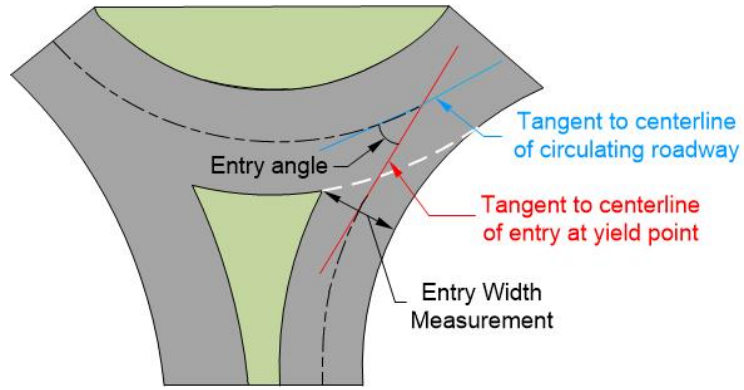

Entry angle and width

5. Path Overlap

In a multilane roundabout, if the vehicles in the entry are aligned toward the central island or the truck apron, the vehicle on the right is pointed toward the inside lane and tends to go in that direction, while the vehicle on the left tends to be squeezed to the right toward the vehicle on the right. Avoid path overlap. Avoid a design that aligns an entering vehicle at the incorrect lane in the circulatory roadway. As a vehicle enters the circulatory roadway it should be headed directly toward its respective lane within the circulatory roadway. For multilane roundabouts, if inside lane is pointing at truck apron this is also considered to be path overlap. If right entry lane is pointing to left circulatory lane, then there is path overlap.

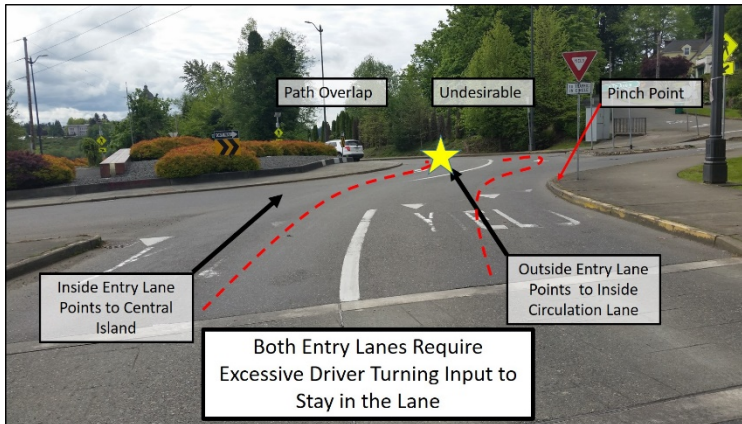

Path overlap conflict

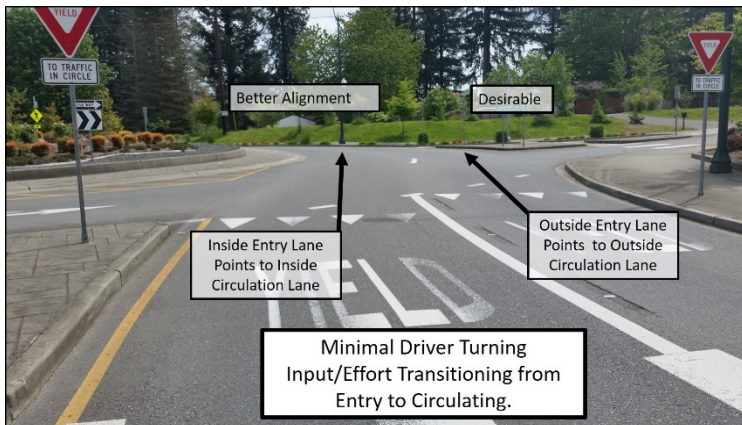

Good path alignment

1320.04(2)(g) Right-Turn Slip Lanes

Right-turn slip lanes are a proven way to increase the “life” of an intersection by removing traffic that would otherwise enter the roundabout and reduce the available capacity to other movements. If a right-turn movement has 250 vehicles/hour or more, or if over 40% of the total approach volume is taking right turns, a slip lane should be considered.

The conflicting volume of vehicles on the merge will influence the length of merge lane prior to termination. Speeds can be very low and vehicles can take turns at these low speeds. Multimodal considerations will influence the length based on crosswalk location and bicycle use.

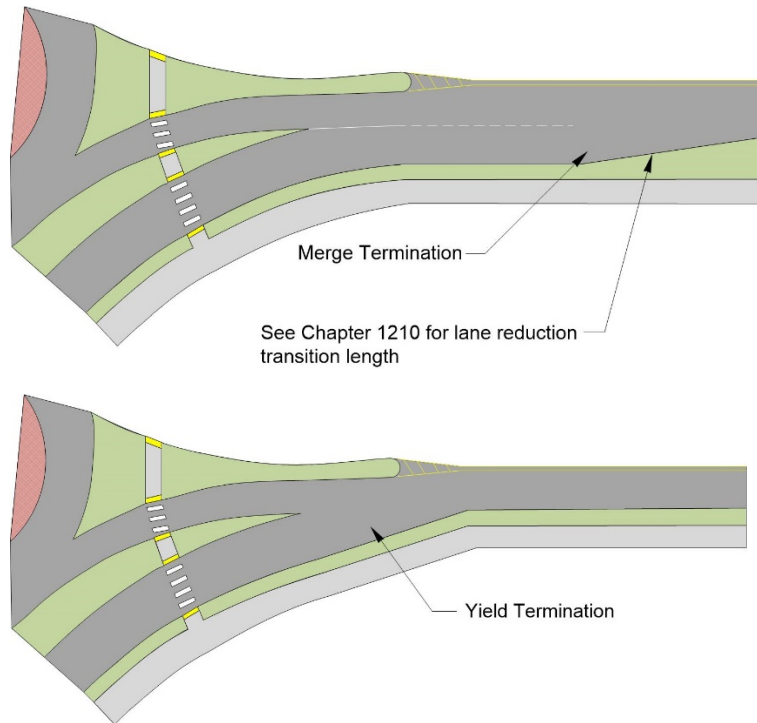

Right-turn slip lanes showing merge and yield termination

1320.04(3) Speed Control

Roundabout operation performance is dependent on low, consistent vehicle speeds. Low and consistent operating speeds facilitate appropriate gap acceptance by an entering driver. Design for travel path operating speeds between 15 mph and 25 mph (see [1320.04\(3\)\(b\)](#)). Design to have low-speed differentials (12 mph or under) between entering and circulating traffic. Multilane roundabouts might have higher speeds along their respective travel paths, but generally 30 mph or less.

The ideal design speed mechanism has the entry and circulating speeds being similar. This varies due to size, shape and context of the roundabout.

The vehicle then moves into and through the circulation lane, being controlled all along by the design speed of the circulating lane. The circulating design speed controls the exit speed; therefore, the exit design speed, as calculated in the Travel Path section below, is not as critical.

Designing geometric entry speed control encourages lower speeds and lower speed differentials at conflict points, which reduces the potential for collisions.

1320.04(3)(a) Chicanes

Chicanes are a type of horizontal deflection used in traffic calming to reduce the speed of vehicles. Research has shown that chicanes have value in slowing down higher approach speeds.

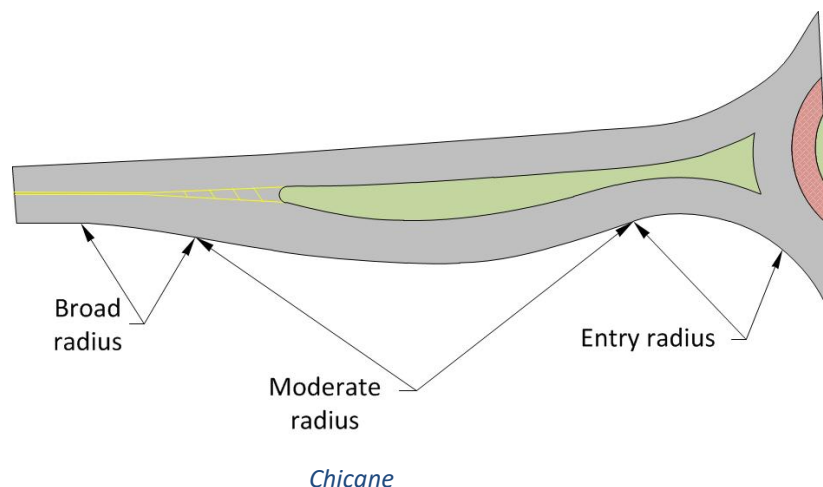

Consider chicanes where posted speeds near the roundabout are 45 mph or higher. Design chicane curves with successively smaller radii in order to successively reduce vehicle speeds approaching the roundabout entry. Use [Exhibit 1320-2](#) to determine the radii-speed relationship (the radii are measured using the offsets recommended in the Travel Paths section). The normal cross slope (superelevation in [1320-2](#)) is 2% however, site conditions may require more based on how you tilt the plane of the roundabout for site specific conditions. A minus (-) 2% drains toward the central island.

Also, consider the grade of the roadways that enter the roundabout, because a vehicle can more easily slow down on an upgrade than on a downgrade. Adjust the length of the deceleration based on the "Adjustment Factors for Grades Greater Than 3%" in *Design Manual* [Exhibit 1360-10](#).

1320.04(3)(b) Travel Paths

Travel path calculations can be used on all roundabout designs to get an understanding of speeds for different paths throughout the roundabout. A travel path is the shortest path through the roundabout, no closer than 5 feet from any curb face or lane line as shown. Use [Exhibit 1320-2](#) and R1 through R5 to determine Travel Path speeds.

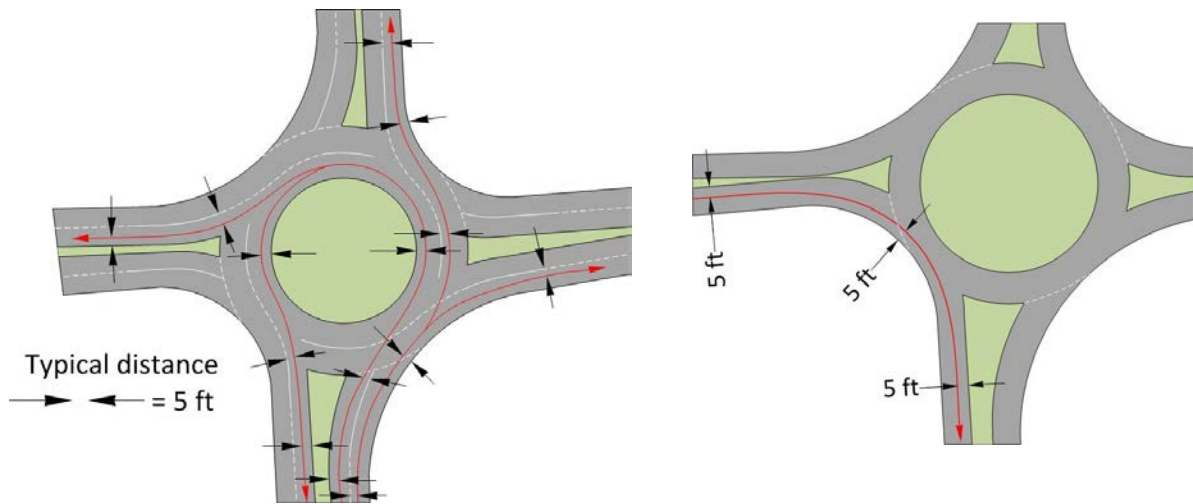

Travel paths

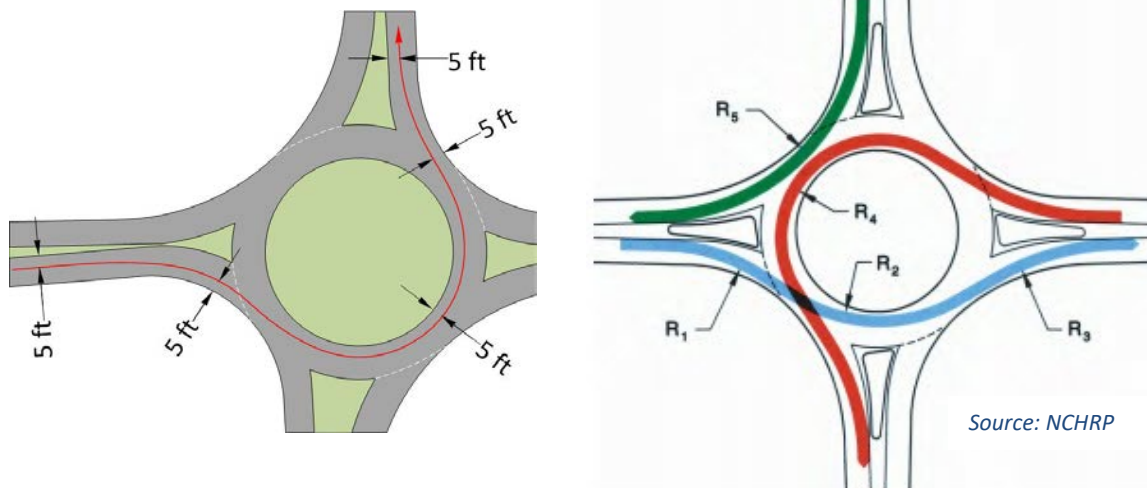

Source: NCHRP

Exhibit 1320-2 Radii-Speed Relationship on Approach Legs and R Value Relationships

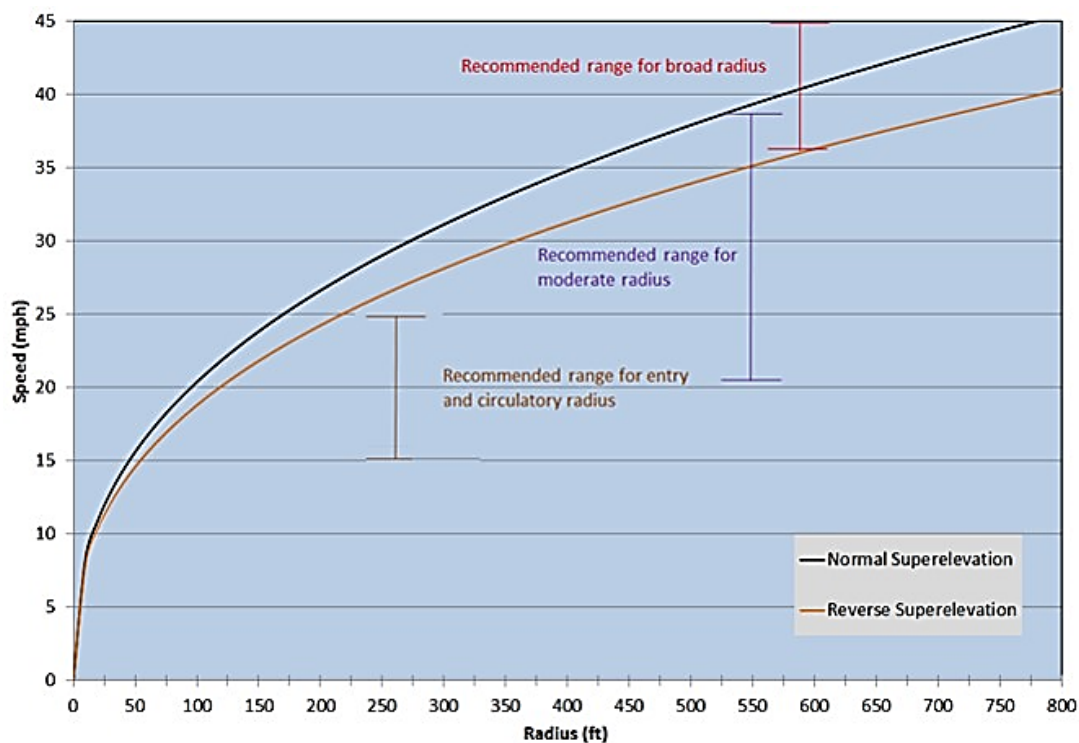
**1320.04(4) Grades**

Do not use grades as a constraint during scoping to rule out a roundabout. Be aware of how the profiles mesh with sight distances and ADA pedestrian requirements.

1320.04(4)(a) Circulatory Roadway

The circulatory roadway grade value should not exceed 4%. Terrain may require benching the roundabout to fit conditions.

1320.04(4)(b) Grade Transitions for Roadway Entry and Exit to the Circulatory Roadway

Consider the grade transitions and make them as long as feasible. When designing for pedestrians see [Chapter 1510](#) and work with region ADA subject matter expert to ensure that grades for ADA compliance at all pedestrian crossing are met.

1320.04(5) Circulatory Roadway Profile and Cross Slope

The preferred profile grades of the circulatory roadway of a roundabout are $\pm 4\%$ or flatter radially around the circulatory lane(s). Profile grades steeper than $\pm 4\%$ require **justification**. It is preferred to bench the roundabout if practicable to reduce profile grade.

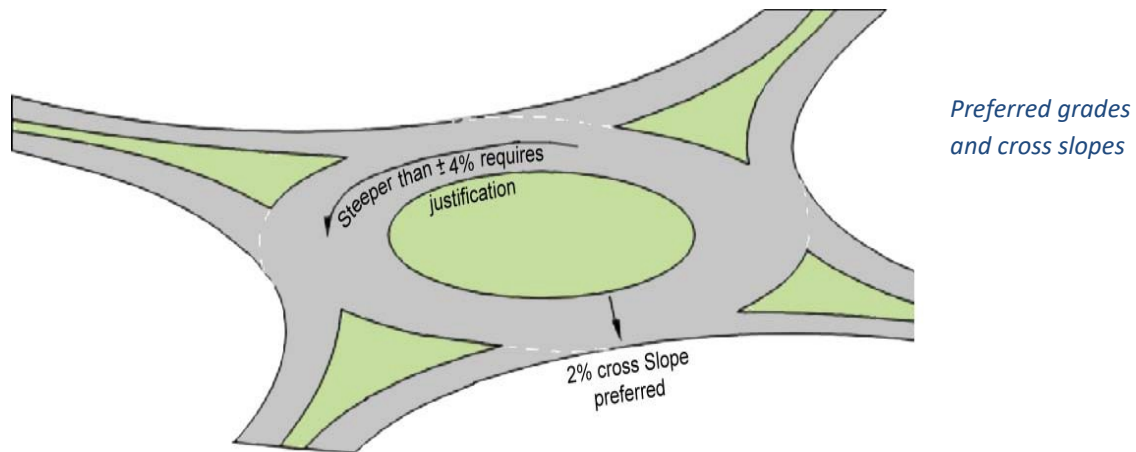

The preferred circulatory roadway cross slope may range from 1.5% to 4.0% (2.0% preferred), away from the central island to promote lower circulating speeds, improve central island visibility, minimize breaks in cross slope of entry and exit lanes, and facilitate drainage of water to the outside of the roundabout.

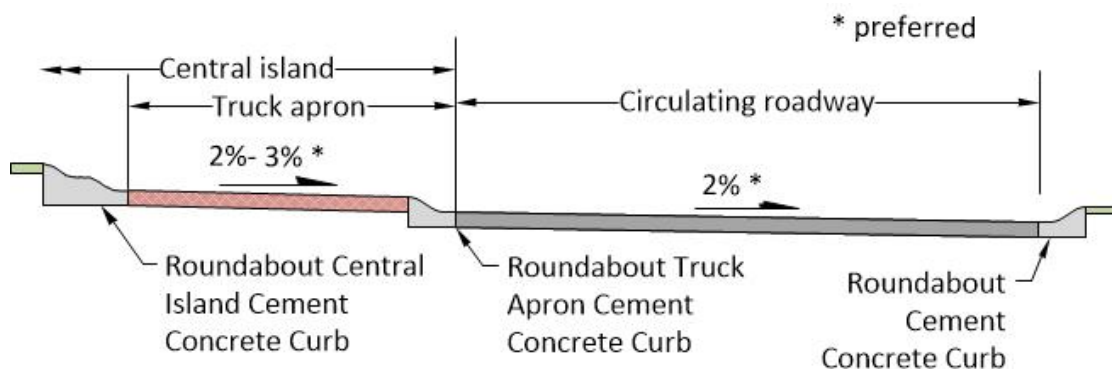

Drawing shows preferred cross slopes. Site conditions and drainage may require slopes outside these ranges.

1320.04(6) *Design Tools*

During the scoping or preliminary geometric design process, do not use truck turning paths alone as a constraint to eliminate a roundabout at an intersection. There are several design tools available to aid in the design of a roundabout. It is important to understand how the software works, its default settings, and its application to the design process.

1320.04(6)(a) Design Vehicle Assumptions

While all highway-to-highway movements require accommodating a WB-67, there are certain assumptions that must be made with software programs that replicate truck swept paths. Determine which truck percentage defaults are to be used (recognizing that truck percentages can range from 2% to 20%) so that different segments can be modeled accurately. Recognize that within a set percentage, WB-67s may only represent a small sample of the entire truck volume on any given day. Therefore, consider whether a WB-67 should be designed for, or accommodated (also see [Chapter 1103](#)).

1. Designing for a WB 67

A roundabout that is being designed for a WB-67 may result in wider lane widths and a larger Inscribed Circle Diameter. For this situation, rolled curb design is critical to the truck's traversing the roundabout (see [Standard Plan F-10.18](#) for curb details). Outside aprons may not be needed in many situations based on AutoTurn[®] modeling and knowledge of driver turning behavior when encountering geometric features.

2. Accommodating a WB 67

A roundabout that is designed to accommodate a WB-67 assumes that a WB-67 could utilize truck aprons to maneuver through the roundabout, if necessary, which should reduce the overall footprint of the roundabout. For this situation, rolled curb is critical to the truck's traversing the roundabout confidently. Although outside truck aprons are needed infrequently, there may be situations where the design may need to incorporate them. Contact HQ Traffic for guidance.

1320.04(6)(b) Truck Swept Path

In some cases, roundabouts of the perfect circular variety with symmetrical roadway attachments require less specific knowledge of truck-turning software and its applications. However, when looking at a non-circular shaped roundabout where the combination of the truck's speed, its turning angle settings, its rear axle locations, and its alignment are the critical design elements to address, a mastery of the software is required. Designers that are unfamiliar with how to apply the software inputs accurately to model a truck's swept path need to contact HQ Traffic Office for guidance. Poor alignment of a truck swept path can result in unnecessarily large roundabout footprints, higher than desired Travel Path speeds, or uncomfortable driving maneuvers by the freight community.

Assume that a truck will travel much slower through a roundabout than the Travel Path speed calculated for passenger vehicles (see [1320.04\(3\)\(b\)](#)). Adjust the software input to allow a slower truck speed in order to make a good engineering judgment about how fast a truck may use a roundabout (for example, for AutoTURN[®] use 5 mph). Design tool default settings don't necessarily allow the maximization of the tool and can prohibit the designer from getting a good, balanced design between passenger car speeds and truck accommodation.



Single lane roundabout - Truck using the truck apron

When using a truck-turning software tool like AutoTURN[®] on multilane roundabouts, assume a truck's travel path will occupy (straddle) parts of two adjacent lanes.

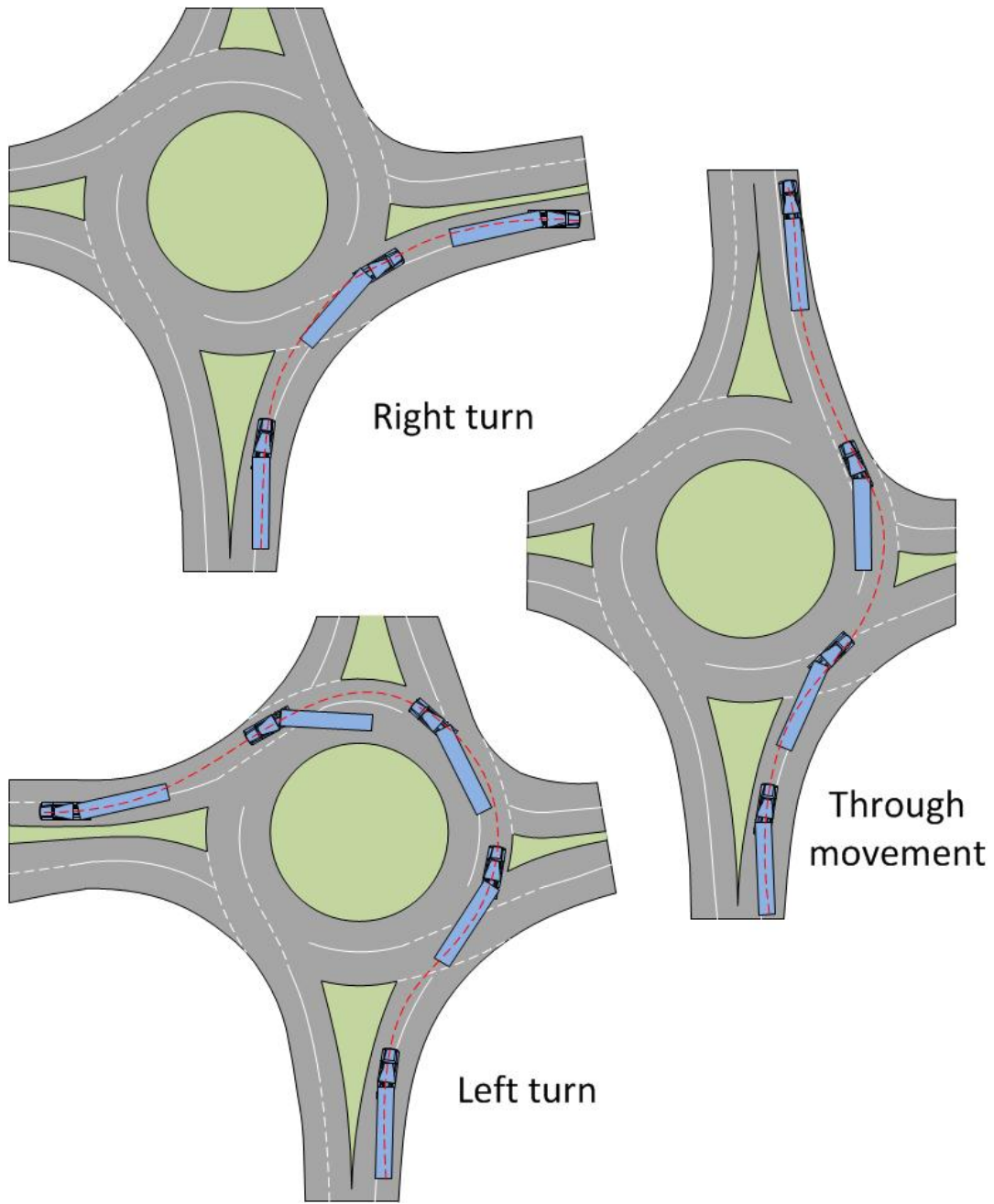

Multilane roundabout - truck straddles lanes

1320.04(7) Sight Distance

Sight distance is an important design consideration at roundabouts. Restricting sight distance across the central island with strategic landscaping may enhance the intersection by making the intersection a focal point and encouraging lower speeds. Work with the region Traffic Engineer and Landscape Architect (HQ if there is no region contact) to determine this balance. Provide sight triangle plan sheets for consideration of landscape design.

1320.04(7)(a) Stopping

Use the design stopping sight distance in [Chapter 1260](#). Anticipated speeds throughout the roundabout can be calculated using [Exhibit 1320-2](#), based on the Travel Path radius and direction of the particular curve. The design stopping sight distance is measured along the vehicle's path as it follows the curvature of the roadway; it is not measured as a straight line.

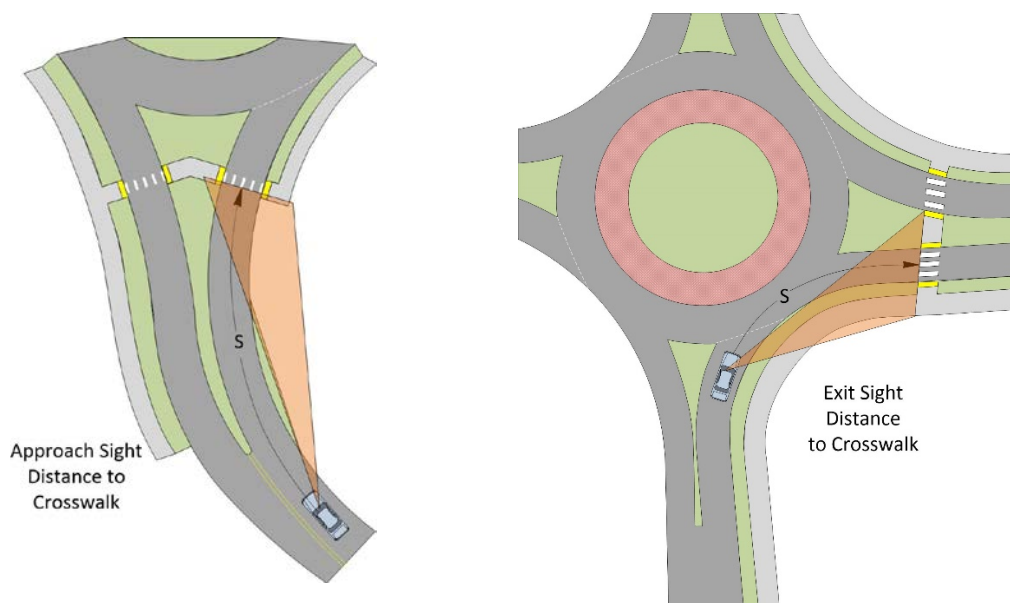

Sight distance – Approach and Exit

1320.04(7)(b) Intersection

Provide minimum intersection sight distance. Longer sight distances can lead to higher vehicle speeds that reduce gap opportunities for entering vehicles. For intersection sight distance at roundabouts, provide entering vehicles a clear view of traffic on the circulating roadway and on the immediate upstream approach in order to aid in judging an acceptable gap.

The intersection sight distance at roundabouts is given in [Exhibit 1320-3](#). The S_1 intersection sight distance is based on the average of the entering and circulating speeds, and the S_2 intersection sight distance is based on the left-turning speed. The sight distance may also be calculated using the intersection sight distance equation given in [Chapter 1310](#) using a time gap (tg) of 4.5 seconds.

Exhibit 1320-3 Intersection Sight Distance

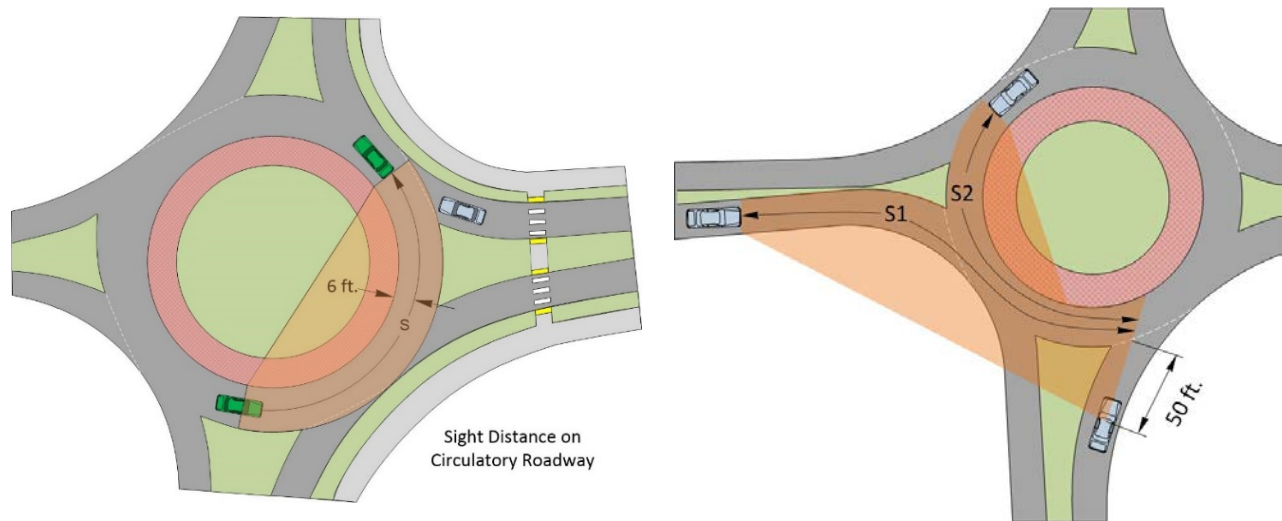
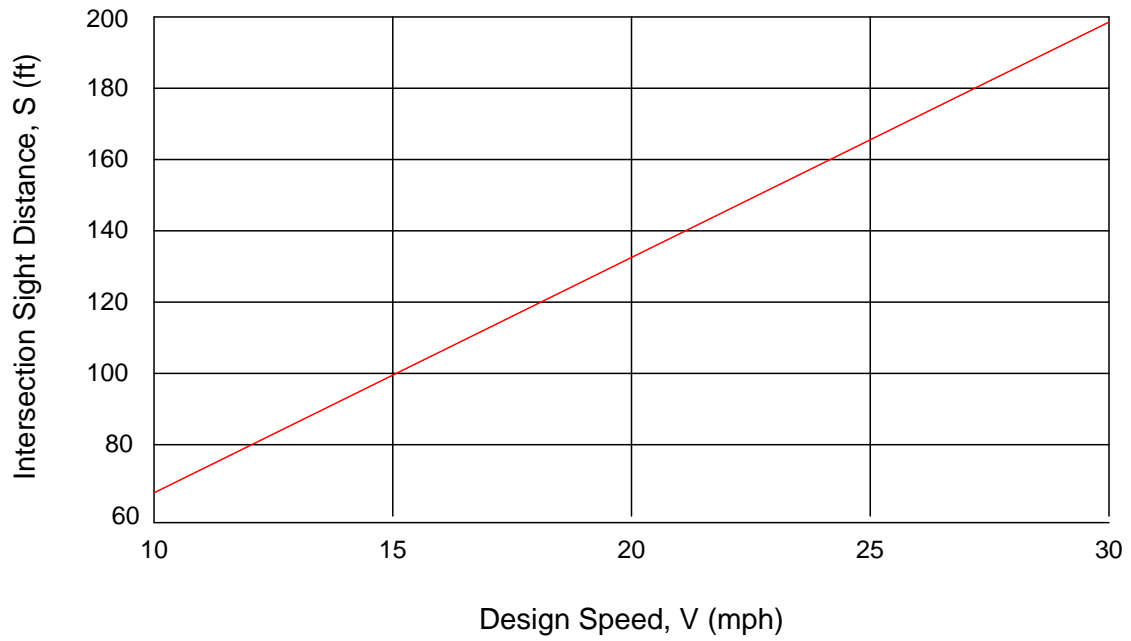

1320.04(8) **Railroad Crossings**

Although it is undesirable to locate any intersection near an at-grade railroad crossing, this situation exists at many locations on the highway system. Experience shows that a roundabout placed near a crossing has some operational advantages. If there is a railroad crossing near the roundabout contact HQ Traffic Office for further guidance.

1320.05 **Pedestrians**

As part of the approved ICE it has already been determined whether pedestrians will use the roundabout and, if so, which legs (see [Chapter 1300](#)).

With the knowledge of where pedestrian facilities are needed, design the roundabout while keeping in mind the ADA requirements for crosswalks, sidewalks, paths, and other pedestrian facilities.

1320.05(1) **Crossing Location**

The pedestrian crossing located on the entry side of a roundabout leg should be at least 20 feet from the yield line so that a pedestrian can walk behind a vehicle that is waiting at the yield line. If there is an extremely large truck percentage, consider moving the crossing to accommodate the most common truck.

The crossing located in the exit side of the roundabout leg can be closer to the roundabout, because as the vehicles leave the roundabout, they accelerate and make it harder to find a break in traffic. As speed increases, drivers are less likely and less able to stop. Verify that no significant, large sight obstructions are located within the sight lines.

1320.05(2) **Splitter Island Pass Through**

Design the splitter island pass through a minimum of 5 feet wide, or the width of the sidewalk, whichever is greater. The length of the pass through (measured back of curb to back of curb of the splitter island) is to be a minimum of 6 feet long measured along the shortest section of the pedestrian path. Consider a "V" shape pass through as shown.

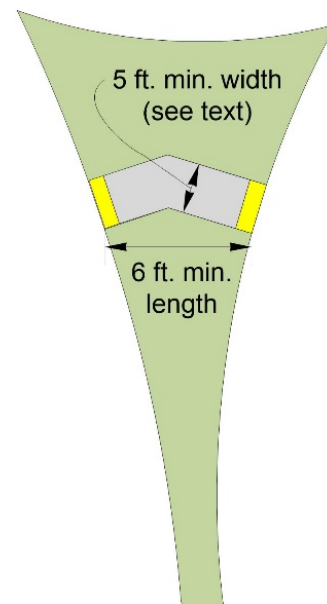

1320.05(3) **Buffers**

Wherever feasible, separate sidewalks from the curb with a buffer. Landscaping or colored concrete are acceptable for the buffer. See WSDOT [Standard Plan F10-18](#) for dimension details. Do not compromise required vehicle sight triangle needs.

The buffer discourages pedestrians from crossing to the central island or cutting across the circulatory roadway of the roundabout. It also helps guide pedestrians with vision impairments to the designated crosswalks, and can accommodate the occasional inexperienced truck driver who encroaches up onto a curb while traversing through the roundabout.

1320.05(4) Curb Ramps

Roundabouts with buffers typically have combination-type curb ramps; otherwise, parallel curb ramps are normally used. (See [Chapter 1510](#) and the [Standard Plans](#) for curb ramp information.)

1320.05(5) Sight Triangles

A vehicle sight triangle specific to pedestrians (see [1320.04\(7\)](#)) must include the whole curb ramp, including the landing, where pedestrians are likely to wait to cross.

It is also important that pedestrians are also able to see approaching vehicles.

1320.05(6) Pedestrian Beacons

On multilane roundabouts, consider installing pedestrian beacons to warn drivers when a pedestrian wants to cross the roadway. Work with the region Traffic Engineer on types and locations of pedestrian beacons.

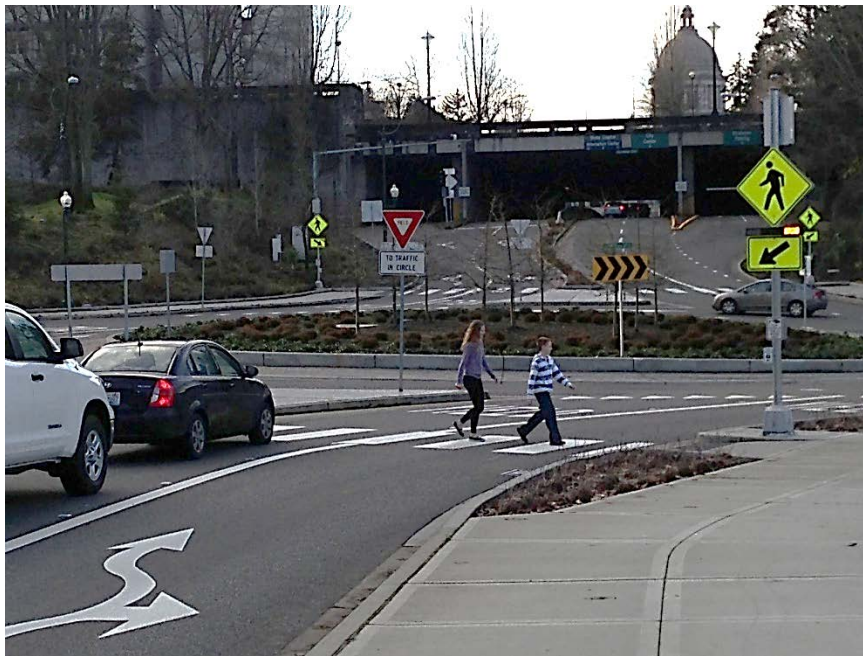

Pedestrian beacons

1320.06 Bicycles

Provide bicyclists with similar options to negotiate roundabouts as they have at other intersections. Consider how they navigate either as motor vehicles or pedestrians depending on the size of the intersection, traffic volumes, their experience level, and other factors.

Bicyclists are often comfortable riding through single-lane roundabouts in low-volume environments in the travel lane with motor vehicles, as speeds are comparable and potential conflicts are low.

At larger or busier roundabouts, cyclists may be more comfortable using ramps connecting to a sidewalk around the perimeter of the roundabout as a pedestrian. Where bicycle lanes or shoulders are used on approach roadways, they should end before the geometry changes the approach to the roundabout.

Contact the HQ Design Office for bicycle ramp design options.

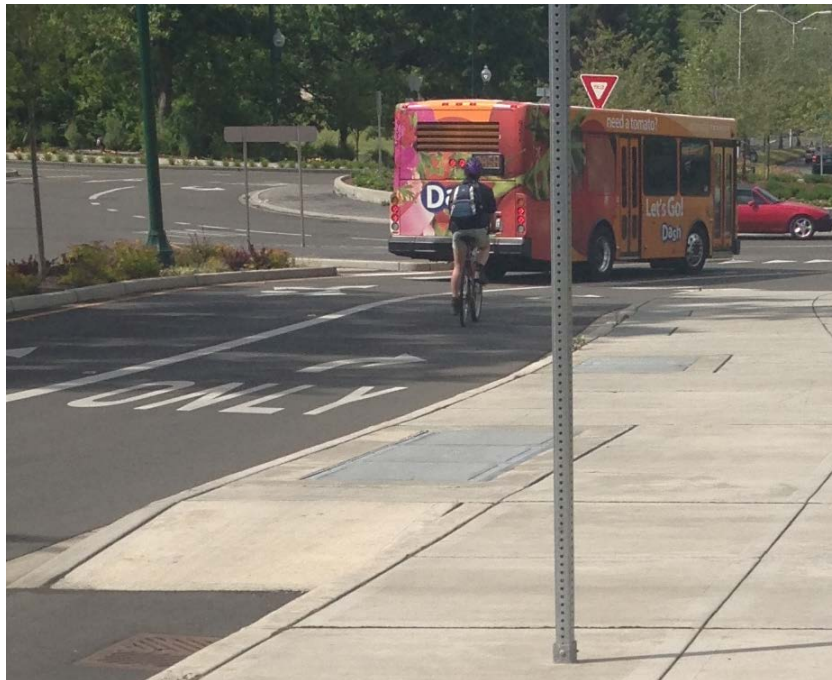

Bicycle rider using lane

1320.07 Signing

The graphic shown is an example of potential signing for a single-lane roundabout. For additional information, refer to the MUTCD, Plan Sheet Library, and the [Standard Plans](#) for details on signing.

A preliminary sign plan is developed to identify existing and proposed signing on state highways. Sign plans on state routes are to be reviewed and approved by the region Traffic Engineer and then furnished to the HQ Traffic Office for review.

The plan provides an easily understood graphic representation of the signing, and it provides statewide uniformity and consistency for regulatory, warning, and guide signs at roundabouts on the state highway system. For roundabouts located near a port, industrial area, or route that accommodates oversized loads, consider using perforated square steel posts.



1320.08 Pavement Marking

See [Standard Plan M-12.10](#) for roundabout pavement marking details. Consult region Traffic on traffic pavement markings and materials.

1320.09 Illumination

Provide illumination for each of the conflict points between circulating and entering traffic in the roundabout and at the beginning of the raised splitter islands. Illuminate raised channelization or curbing. Position the luminaires on the upstream side of each crosswalk to improve the visibility of pedestrians. Light the roundabout from the outside in toward the center. This improves the visibility of the central island and circulating vehicles to motorists approaching the roundabout. Ground-level lighting within the central island that shines upward toward objects in the central island can also improve their visibility. Consult with the region Traffic office for illumination design. (See [Chapter 1040](#) for additional information on illumination.) On higher-speed approaches, consider internally illuminated bollards (IIB) in lieu of other illumination.

1320.10 Road Approach, Parking, and Transit Facilities

Road approach (road or driveway) connections to the circulating roadway are not allowed at roundabouts unless they are designed as a leg to the roundabout. It is desirable that road approaches not be located on the approach or departure legs within the length of the splitter island. The minimum distance from the circulating roadway to a road approach is controlled by corner clearance using the outside edge of the circulating roadway as the crossroad. When minimum corner clearance cannot be met, document the decision in accordance with Chapters 530 and 540.

If a parcel adjoins two legs of the roundabout, it is acceptable to provide a right-in/right-out driveway within the length of the splitter islands on both legs. This provides for all movements; design both driveways to accommodate their design vehicles.

Roadways between roundabouts may have restrictive medians with left-turn access provided with U-turns at the roundabouts.

Parking is not allowed in the circulating roadway or on the entry or exit roadway within the length of the splitter island.

Transit stops are not allowed in the circulating roadway, in the approach lanes, or in the exit lanes prior to the crosswalk. Locate transit stops on the roadway before or after the roundabout, in a pullout, or where the pavement is wide enough that a stopped bus does not block the through movement of traffic or impede sight distance.



Right in / right out driveways

1320.11 Geometric Design Peer Review

Conduct a peer review of the roundabout design with the following participants.

- Region Traffic Office
- Assistant State Traffic Engineer
- Region Project Development Engineer or Engineering Manager
- Assistant State Design Engineer

The intent of this peer review is to review, discuss, evaluate, and provide feedback on the 2-D roundabout layout design in order to finalize the channelization plan.

1320.12 Documentation and Approvals

Refer to [Chapter 300](#) for design documentation and approval requirements.

1320.13 References

1320.13(1) *Federal/State Laws and Codes*

See [Chapter 1510](#) for Americans with Disabilities Act Policy and references

[Revised Code of Washington \(RCW\) 47.05.021](#), Functional classification of highways

[Washington Administrative Code \(WAC\) 468-58-080](#), Guides for control of access on crossroads and interchange ramps

1320.13(2) *Design Guidance*

Roundabout Cement Concrete Curbs: [Standard Plan F-10.18-00](#)

Roundabout Pavement Markings: [Standard Plan M-12.10](#)

[Manual on Uniform Traffic Control Devices for Streets and Highways](#), USDOT, FHWA, as adopted and modified by [Chapter 468-95 WAC](#) "Manual on uniform traffic control devices for streets and highways" (MUTCD)

[Standard Plans for Road, Bridge, and Municipal Construction \(Standard Plans\)](#), M 21 01, WSDOT

[Standard Specifications for Road, Bridge, and Municipal Construction \(Standard Specifications\)](#), M 41-10, WSDOT

1320.13(3) *Supporting Information*

Roundabouts: An Informational Guide Second Edition 2000, NCHRP Report 672, Transportation Research Board, 2010 <http://nacto.org/docs/usdg/nchrprpt672.pdf>

Roundabouts: An Informational Guide First Edition 2010, FHWA-RD-00-067, USDOT, FHWA
<http://www.fhwa.dot.gov/publications/research/safety/00067/index.cfm>

Highway Capacity Manual 2010 (HCM 2010), Transportation Research Board, National Research Council, Washington D.C., 2000

A Policy on Geometric Design of Highways and Streets (Green Book), AASHTO

“Crash Reductions Following Installation of Roundabouts in the United States,” Insurance Institute for Highway Safety, March 2000

🔗 https://www.dot.ny.gov/main/roundabouts/files/insurance_report.pdf

“Long-Term Trends in Public Opinion Following Construction of Roundabouts,” Insurance Institute for Highway Safety, 2007

🔗 <http://trrjournalonline.trb.org/doi/abs/10.3141/2019-26>

Truck and Bus Safety; Roundabouts, *Journal of the Transportation Research Board* No. 2585, 2016.

🔗 <http://trrjournalonline.trb.org/toc/trr/2585/>

Understanding Flexibility in Transportation Design – Washington, WSDOT, 2005

🔗 www.wsdot.wa.gov/research/reports/600/638.1.htm

- 1600.01 General
- 1600.02 Clear Zone
- 1600.03 Mitigation Guidance
- 1600.04 Medians
- 1600.05 Other Roadside Safety Features
- 1600.06 Documentation
- 1600.07 References

1600.01 General

Roadside safety addresses the area outside the roadway and is an important component of total highway design. There are numerous reasons why a vehicle leaves the roadway, including driver error and behaviors. Regardless of the reason, a roadside design can reduce the severity and subsequent consequences of a roadside encroachment. From a crash reduction and severity perspective, the ideal highway has roadsides and median areas that are relatively flat and unobstructed by objects. It is also recognized that different facilities have different needs and considerations, and these issues are considered in any final design.

It is not possible to provide a clear zone free of objects at all locations and under all circumstances. The engineer faces many tradeoffs in design decision-making, balancing needs of the environment, right of way, and various modes of transportation. The fact that recommended design values related to the installation of barrier and other mitigation countermeasures are presented in this chapter, does not mean that WSDOT is required to modify or upgrade existing locations to meet current criteria.

Roadside safety may be addressed by projects identified through priority programming, during certain preservation project activities (See [Chapter 1120](#)), or may be considered by projects as part of a safety analysis (See [Chapter 321](#)). Elements such as sideslopes, fixed objects, and water are all features that a vehicle might encounter when it leaves the roadway and become part of such an analysis.

On projects where the need to mitigate objects is determined based on location related to Design Clear Zone, consider the following mitigation measures in this order: (See [1600.02](#) Clear Zone)

1. Remove
2. Relocate
3. Redesign a fixed object by using breakaway features or making the fixed object traversable (See Section [1600.03](#))
4. Shield with a traffic barrier
5. Delineate (To only delineate requires a Design Analysis. If this seems to be your only option, consult your Region traffic barrier expert or your Region's ASDE.)

Factors for selecting a mitigation measure include, but may not be limited to:

- Crash severity potential
- Maintenance needs
- Cost (initial and life cycle costs)

Rumble strips can be employed to reduce the potential for lane departure or roadside encroachment in certain contexts (see Section [1600.05\(1\)](#)). Use traffic barriers when other measures cannot reasonably be accomplished and conditions are appropriate based on an engineering analysis (See [Chapter 1610](#)).

1600.02 Clear Zone

A clear roadside border area is a primary consideration when analyzing roadside and median features (as defined in Section [1600.03](#)). The intent is to provide as much clear, traversable area for a motorist to recover as practicable given the function and context of the roadway and the potential tradeoffs. The Design Clear Zone is used to evaluate the adequacy of the existing clear area and proposed modifications of the roadside. When considering the placement of new objects along the roadside or median, evaluate the potential for impacts and try to select locations with the least likelihood of an impact by an errant motorist.

In situations where the Design Clear Zone is beyond WSDOT right of way, evaluate options on a case-by-case basis. Consider the nature of the objects within the Design Clear Zone, the roadway geometry, traffic volume, and crash history. Coordinate with adjacent property owners when proposed options include any work beyond WSDOT right of way. At a minimum, provide clear zone to the limits of the WSDOT right of way.

Clear zone is measured from the edge of the through traveled way. All projects that alter the relationship between the through lane and the roadside by widening or realignment have altered the existing clear zone, and require an evaluation of objects in the clear zone. Auxiliary lanes longer than 400 feet generally operate the same as a through lane and should be considered through lanes for the purpose of determining Design Clear Zone.

1600.02(1) Design Clear Zone along Limited Access State Highways and Other State Highways Outside Incorporated Cities and Towns

Use the Design Clear Zone Inventory form ([Exhibit 1600-3](#)) to identify features to be mitigated and propose actions taken to address those features.

Guidance for establishing the Design Clear Zone for highways outside incorporated cities is provided in [Exhibit 1600-2](#). This guidance also applies to limited access facilities within the city limits. Providing a clear recovery area that is consistent with this guidance does not require any additional documentation. However, there might be situations where it is not practicable to provide these recommended distances. In these situations, document the decision as a Design Analysis as discussed in [Chapter 300](#).

There is flexibility in establishing the Design Clear Zone in urbanized or urbanizing areas where operating speeds are 35 mph or less. To achieve this flexibility, use a Design Analysis to establish the Design Clear Zone that presents the tradeoffs associated with the decision. Provide information on the benefits and effects of the Design Clear Zone selected in the Design Analysis, including safety, aesthetics, the environment, economics, modal needs, and access control. Although not a WSDOT policy document on clear zone, Chapter 10 of the *AASHTO Roadside Design Guide* provides information to consider when performing a Design Analysis in urbanized areas.

In curbed sections, and where applicable (e.g. parking), provide an 18-inch operational offset beyond the face of curb for lateral clearance to accommodate opening car doors or large side mirrors.

1600.02(2) Design Clear Zone Inside Incorporated Cities and Towns

For managed access state highways within an urban area, it might not be practicable or appropriate to provide the Design Clear Zone distances shown in [Exhibit 1600-2](#). Roadways within an urban area generally have curbs and sidewalks and might have objects such as trees, poles, benches, trash cans, landscaping, and transit shelters along the roadside.

For projects on city streets as state highways that include work in those areas that are the city's responsibility and jurisdiction (see [Exhibit 1600-1](#)), design the project using the city's development/design standards. The standards adopted by the city must meet the requirements set by the City Design Standards Committee for all arterial projects, bike projects, and federal-aid projects. See the [Local Agency Guidelines](#), Chapter 42, for more information on this Committee.

Exhibit 1600-1 City and State Responsibilities and Jurisdictions

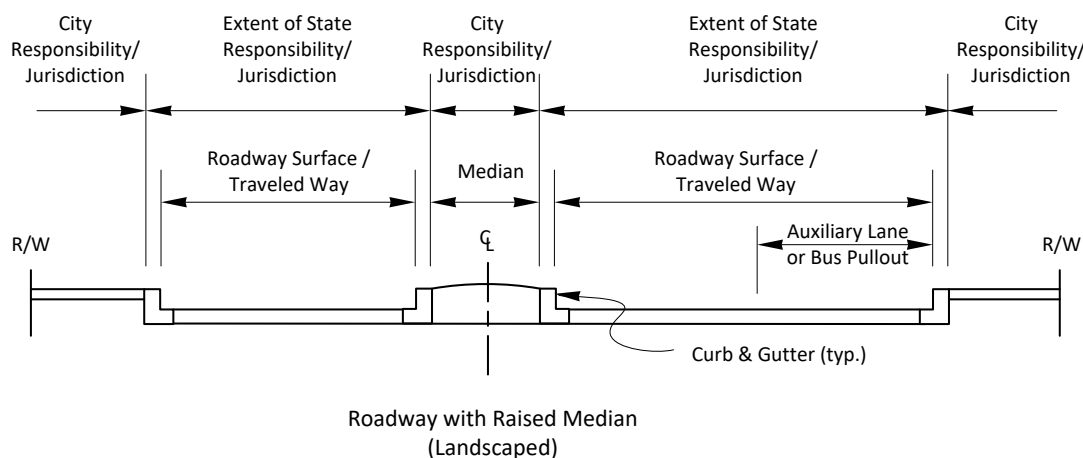

1600.02(2)(a) Roadside and Median

For managed access state highways inside incorporated cities, it is the city's responsibility to establish an appropriate Design Clear Zone in accordance with guidance contained in the City and County Design Standards ([Local Agency Guidelines](#), Chapter 42.) [Exhibit 1600-1](#) shows an example of state and city responsibilities and jurisdictions. Document the Design Clear Zone established by the city in the Design Documentation Package. Have the responsible transportation official from the city (e.g., City Engineer) document the Design Clear Zone, and their acknowledgement and acceptance of the design and maintenance responsibilities for project roadsides and medians, in a letter addressed to WSDOT, and file this letter as part of the local agency coordination in the Design Documentation Package. Respond to the sender acknowledging receipt.

1600.02(3) Design Clear Zone and Calculations

Use [Exhibit 1600-2](#) to determine the Design Clear Zone based on posted speed, sideslopes, and traffic volume at any given location. Note that there are no clear zones distances in the table for 3H:1V fill slopes. Although fill slopes between 4H:1V and 3H:1V are considered traversable if

free of fixed objects, these slopes are defined as nonrecoverable slopes. A vehicle might be able to begin recovery on the shoulder, but likely will not be able to further this recovery until reaching a flatter area (4H:1V or flatter) at the toe of the slope. Under these conditions, the Design Clear Zone distance is called a recovery area. The method used to calculate the recovery area and an example are shown in [Exhibit 1600-4](#).

For ditch sections, the following criteria determine the Design Clear Zone:

(a) For ditch sections with foreslopes 4H:1V or flatter (see [Exhibit 1600-5](#), Case 1, for an example), the Design Clear Zone distance is the greater of the following:

- The Design Clear Zone distance for a 10H:1V cut section based on speed and the average daily traffic (ADT); or
- A horizontal distance of 5 feet beyond the beginning of the backslope.

When a backslope steeper than 3H:1V continues for a horizontal distance of 5 feet beyond the beginning of the backslope, it is not necessary to use the 10H:1V cut slope criteria.

(b) For ditch sections with foreslopes steeper than 4H:1V and backslopes steeper than 3H:1V, the Design Clear Zone distance is 10 feet horizontal beyond the beginning of the backslope (see [Exhibit 1600-5](#), Case 2, for an example).

(c) For ditch sections with foreslopes steeper than 4H:1V and backslopes 3H:1V or flatter, the Design Clear Zone distance is the distance established using the recovery area formula (see [Exhibit 1600-4](#); also see [Exhibit 1600-5](#), Case 3, for an example).

1600.03 Mitigation Guidance

There are three general categories of features to be mitigated: sideslopes, fixed objects, and water. This section provides guidance for determining when these objects are to be mitigated. For each case, the following conditions need consideration:

- Locations with an expected elevated crash frequency.
- Locations with pedestrian and bicyclist usage (See Chapters [1510](#), Pedestrian Facilities, [1515](#), Shared-Use Paths, and [1520](#), Roadway Bicycle Facilities).
- Locations where speed management measures are present or contemplated (See [Chapter 1103](#)).
- Locations with playgrounds, monuments, and other locations with high social value.
- Locations where redirection landforms, also referred to as earth berms, were installed to mitigate objects located in depressed medians and at roadsides. They were constructed of materials that provided support for a traversing vehicle. With slopes in the range of 2H:1V to 3H:1V, they were intended to redirect errant vehicles. The use of redirection landforms has been discontinued as a means for mitigating fixed objects. Where redirection landforms currently exist as mitigation for a fixed object, provide designs where the landforms, and the feature(s) they were intended to mitigate, are removed, relocated, made crashworthy, or shielded with barrier.

The use of a traffic barrier for features other than those described below requires justification.

1600.03(1) Side Slopes

1600.03(1)(a) Fill Slopes

Fill slopes can increase the crash potential for an errant vehicle with the degree of severity dependent upon the slope and height of the fill. Providing fill slopes that are 4H:1V or flatter can mitigate this condition. If flattening the slope is not feasible or cost-effective, the installation of a barrier might be appropriate. [Exhibit 1600-6](#) represents a selection procedure used to determine whether a fill sideslope constitutes a condition for which a barrier is a cost-effective mitigation. The curves shown on [Exhibit 1600-6](#) are based on the severity indexes and represent the points where total costs associated with a traffic barrier are equal to the predicted cost of crashes over the service life for selected slope heights without traffic barrier. If the ADT and height of fill intersect on the “Barrier Recommended” side of the embankment slope curve, then provide a barrier if flattening the slope is not feasible or cost-effective.

Do not use [Exhibit 1600-6](#) for slope design. Design slopes consistent with guidance in [Chapter 1239](#), evaluating designs with clear, traversable slopes before pursuing a barrier option. Also, if [Exhibit 1600-6](#) indicates that barrier is not recommended at a slope, that result is not justification for a Design Analysis. For example, if the ADT is 4,000 and the embankment height is 10 feet, barrier might be cost-effective for a 2H:1V slope, but not for a 2.5H:1V slope. This process only addresses the crash potential on the slope. Objects on the slope can compound the condition. Where barrier is not cost-effective, use the recovery area formula to evaluate fixed objects on critical fill slopes less than 10 feet high.

1600.03(1)(b) Cut Slopes

A traversable cut slope reduces crash potential. The exception is a rock cut with a rough face that might cause vehicle snagging rather than providing relatively smooth redirection.

Analyze the location and evaluate the roadside characteristics, crash potential, and other benefits of treatment of rough rock cuts located within the Design Clear Zone. Conduct an individual investigation for each rock cut or group of rock cuts. A cost-effectiveness analysis that considers the consequences of doing nothing, removal, smoothing of the cut slope, grading at the base of the rock cut to provide a smooth surface, and other viable options to reduce the severity of the condition can be used to determine the appropriate treatment. Some potential mitigative options are roadside barrier and rumble strips.

1600.03(2) Fixed Objects

Use engineering judgment when considering the following objects for mitigation:

- Wooden poles or posts with cross-sectional areas greater than 16 square inches that do not have breakaway features.
- Signs, illumination, cameras, weather stations, and other items mounted on non-breakaway poles, cantilevers, or bridges.
- Trees with a diameter of 4 inches or more, measured at 6 inches above the ground surface.
- Fixed objects extending above the ground surface by more than 4 inches; for example, boulders, concrete bridge rails, signal/electrical/ITS cabinets, piers, and retaining walls.
- Drainage elements, such as culvert and pipe ends.

1600.03(2)(a) Trees

When evaluating new plantings or existing trees in the Design Clear Zone, consider the maximum allowable diameter of 4 inches, measured at 6 inches above the ground when the tree has matured. When removing trees within the Design Clear Zone, complete removal of stumps is preferred. However, to avoid significant disturbance of the roadside vegetation, larger stumps may be mitigated by grinding or cutting them flush to the ground and grading around them.

Removal of trees may reduce the severity of impacts of roadway departure. It is recognized that different facilities have different needs and considerations, and these issues are considered in any design. For instance, removal of trees within the Design Clear Zone may not be desirable in suburban, urban, or urban core areas, or in other land use contexts that provide for non-motorized uses, such as a forest, park, or within a scenic and recreational highway. In these situations, analyze crash reports' contributing factors to determine whether roadside vegetation is contributing to the severity of crashes. If large vegetation is removed, consult guidance contained in established vegetation management plans, corridor plans, or the [WSDOT Roadside Manual](#). Additional guidance for maintenance of roadside vegetation can be found for some routes in the Memorandum of Understanding between the US Forest Service and WSDOT, [Highways Over National Forest Lands](#), dated July 2002. In incorporated cities, refer to guidance in 1600.02(2).

1600.03(2)(b) Mailboxes

For mailboxes located within the Design Clear Zone, provide supports and connections as shown in the [Standard Plans](#). The height from the ground to the bottom of the mailbox is 3 feet 3 inches. This height may vary from 3 feet 3 inches to 4 feet if requested by the mail carrier. If the desired height is to be different from 3 feet 3 inches, provide the specified height in the contract plans. (See [Exhibit 1600-7](#) for installation guidelines.) Coordinate with homeowners when upgrading mailboxes.

Where sidewalks are present, contact the postal service to determine the most appropriate mailbox location. Locate mailboxes on limited access highways in accordance with [Chapter 530](#), Limited Access. A turnout, as shown in [Exhibit 1600-7](#), is not needed on limited access highways with shoulders of 6 feet or more where only one mailbox is to be installed. On managed access highways, mailboxes are to be on the right-hand side of the road in the postal carrier's direction of travel. Avoid placing mailboxes along high-speed, high-volume highways. Locate Neighborhood Delivery and Collection Box Units outside the Design Clear Zone.

1600.03(2)(c) Culvert Ends

Provide a traversable end treatment when the culvert end section or opening is within the Design Clear Zone. No part of the culvert or end treatment should protrude more than 4" above the ground line. Traversable end treatments include:

- **Culverts perpendicular to direction of travel:**
 - Culverts 36" and smaller as measured parallel to the direction of travel (Consider treating these culvert ends even outside Design Clear Zone)
 - For roadway side slopes 4:1 or steeper, see Standard Plan B-70.20
 - For slopes flatter than 4:1 (see Standard Plan B-70.20 and note "treatment for slopes flatter than 4:1")
 - Culverts larger than 36 inches, as measured parallel to the direction of travel, require Type 1 safety bars. (See Standard Plan B-75.50)

- **Culverts parallel to direction of travel require safety bars:**
 - Type 2 safety bars are used for circular culverts up to 36 inches. (See Standard Plan B-75.60)
 - Type 3 safety bars are used for metal end sections of circular culverts between 36 inches and 60 inches and for metal end sections of arched culverts between 30 inches and 72 inches. (See Standard Plan B-80.20)
 - Type 4 safety bars are used for metal end sections of circular culverts between 15 inches and 60 inches and for metal end sections of arched culverts between 18 inches and 72 inches. (See Standard Plan B-80.40)

Bars are permitted where they will not significantly affect the stream hydraulics and where debris drift is minor. Consult the Region Maintenance Office and Region Hydraulics to verify these conditions. If debris drift is a concern, consult Region Hydraulics for options to reduce the amount of debris that can enter the pipe.

1600.03(2)(d) Signposts

Whenever possible, locate signs behind the standard run, but not the end terminals, of existing or planned traffic barrier installations to eliminate the need for breakaway posts, and place them such that the sign face is behind the barrier. (See [Chapter 1020](#) for additional information regarding the placement of signs.) Use the *MUTCD* to guide placement of the warning sign.

Signposts with cross-sectional areas greater than 16 square inches that are within the Design Clear Zone and not located behind a barrier are to have breakaway features as shown in the *Standard Plans*.

Sign bridges and cantilever sign supports are designed for placement outside the Design Clear Zone or must be shielded by barrier.

1600.03(2)(e) Traffic Signal Standards/Posts/Supports

Breakaway signal posts generally are not feasible or desirable, and barrier is not generally an option due to constraints typically found at intersection locations. To reduce potential for drivers making contact with posts, and to avoid impeding the movement of pedestrian or bicyclist traffic in the vicinity, locate posts in accordance with [Chapter 1330](#).

For ramp meter systems, single lane ramp meters use breakaway Type RM signal standards. Multilane ramp meters normally use Type II signal standards, which must either be located outside of clear zone for all adjacent roadways or be protected by some type of barrier.

1600.03(2)(f) Fire Hydrants

Fire hydrants are typically allowed on WSDOT right of way by franchise or permit. Fire hydrants that are made of cast iron can be expected to fracture on impact and can therefore be considered a breakaway device. Any portion of the hydrant that will not be breakaway must not extend more than 4 inches above the ground. In addition, the hydrant must have a stem that will shut off water flow in the event of an impact. Provide mitigation to address potential vehicle impact with hydrant types not expected to fracture on impact.

1600.03(2)(g) Utility Poles

Since utilities often share the right of way, utility objects such as poles are often located along the roadside. It is normally undesirable or infeasible to install barrier for all of these objects, so mitigation is usually in the form of relocation (underground or to the edge of the right of way) or delineation. In some instances where there is a history of impacts with poles and relocation is not possible, a breakaway design might be appropriate.

Evaluate roadway geometry and crash history as an aid in determining locations that exhibit the greatest need. Contact the Headquarters (HQ) Design Office for information on breakaway features. Coordinate with the HQ Utilities Unit when appropriate.

For policy and guidance on locating utility poles along state highways, also see Chapter 9 of the *Utilities Manual*. Document the determination of appropriate mitigative measures and coordination with the region Utilities Office.

1600.03(2)(h) Light Standards

Provide breakaway light standards unless fixed light standards can be justified, even if outside of the Design Clear Zone. Fixed light standards may be justified if one of the following criteria are met:

- Posted speed is below 35 MPH (See [1600.02\(1\)](#) for Design Clear Zone in urbanized and urbanizing areas, and [1600.02\(2\)](#) in cities).
- Mounted on barrier (top or elbow mount).
- Behind traffic barrier, beyond the barrier's deflection design value (see [Chapter 1610](#)).
- Within a parking lot.
- Along isolated walkways and shared-use paths that are outside of Design Clear Zone.

Breakaway light standards require additional embankment widening to ensure proper operation, as shown in the *Standard Plans*. If this additional embankment widening cannot be constructed, such as in cases where the toe of slope will extend beyond right of way or into a water body or other sensitive area, fixed bases and traffic barrier may be considered. Document the decision to use fixed bases in the Design Documentation Package.

1600.03(3) Water

Water with a depth of 2 feet or more and located with a likelihood of encroachment by an errant vehicle is to be evaluated for mitigation.

Perform a benefit-cost analysis that considers the consequences of doing nothing versus installing a longitudinal barrier to determine the appropriate treatment (see [Chapter 321](#) for more information). For fencing considerations along water features see [Chapter 560](#).

1600.04 Medians

Median barriers are normally used on limited access, multilane, high-speed, high-volume highways. These highways generally have posted speeds of 45 mph or higher. Median barrier is normally placed on limited access state highways. Where median barrier is used on managed access highways where bicyclists, pedestrians, and transit users are present, consider providing

accessible barrier openings at crossing locations. Providing access through median barrier results in openings, therefore, end treatments are needed.

Provide median barrier on full access control multilane highways with median widths of 50 feet or less and posted speeds of 45 mph or higher. Consider median barrier on highways with wider medians or lower posted speeds when there is a history of cross-median crashes. Contact the HQ Design Office for more information.

Provide a left-side shoulder when installing median barrier using width criteria given in [Chapter 1230](#). Consider a wider shoulder area where the barrier might cast a shadow on the roadway and hinder the melting of ice. (See [Chapter 1239](#) for additional criteria for placement of median barrier, [Chapter 1610](#) for information on the types of barriers that can be used, and [Chapter 1260](#) for lateral clearance on the inside of a curve to provide the needed stopping sight distance.) Consider the need to accommodate drainage as a result of the addition of median barrier treatments.

When median barrier is being placed in an existing median, identify the existing crossovers and enforcement observation points. Provide the needed median crossovers in accordance with [Chapter 1370](#), considering enforcement needs. [Chapter 1410](#) provides guidance on HOV enforcement.

1600.05 Other Roadside Safety Features

1600.05(1) Rumble Strips

Rumble strips are milled grooves or rows of raised pavement markers placed perpendicular to the direction of travel, or a continuous sinusoidal pattern milled longitudinal to the direction of travel, intended to alert inattentive drivers to a potential lane departure. A sinusoidal pattern can be used when a low noise design is desired.

The pavement receiving rumble strips needs to be in good condition and thick enough to support the rumble strips. Certain pavement types, such as open graded pavements, are not suitable for rumble strip installation. Grinding rumble strips into inadequate pavement will lead to premature deterioration of the surrounding pavement. Areas where the pavement is inadequate for rumble strip installation require removal and replacement of the existing pavement at and adjacent to the location of the rumble strip. Consult with the Region Materials Engineer to determine whether the existing pavement is adequate for rumble strip installation. The Region Materials Engineer will provide a pavement design for removing and replacing the existing pavement near the rumble strip if needed. When installing both rumble strips and recessed lane markers, follow the Standard Plan to avoid overlapping the grindings.

Installing rumble strips in bituminous surface treatment (or BST) or other thin surface treatments can expose pavement structure and lead to delamination. In new rumble strip locations where BST will be applied on an Hot Mix Asphalt (HMA) pavement, install the rumble strips in the HMA pavement before placing the BST. In existing rumble strip locations, note that a single application of BST on top of an existing rumble strip installation typically results in satisfactory rumble strip depth. Where rumble strips currently exist and an additional BST application is contemplated, evaluate whether the depth of the grooves following paving will provide their continuing function to alert drivers. If not, or in the case of an HMA overlay, it may be necessary to remove existing rumble strips and install new ones.

Provide an offset to the longitudinal paving joint so that rumble strips are not ground into the joint where practicable. For additional guidance on surface preparation and pavement stability, refer to the [WSDOT Pavement Policy](#).

The noise created when vehicle tires contact a rumble strip may adversely impact nearby residences and other land uses. Left-turning or passing vehicles, frequent passing maneuvers on two lane highways, and off-tracking of vehicles or trailers in tight radius curves, are examples of situations where incidental contact can happen. Noise impacts may be anticipated, and a low noise rumble strip design may be warranted, when installing rumble strips in urban growth areas, and/or within 600 feet of a residence, school, church, or campground. In situations where a low noise rumble strip is desired but is not feasible, measures can still be taken to reduce incidental contact, including discontinuing the rumble strip through frequently used road approaches, through passing zones, and in tight radius curves. Contact HQ Design for more information about low noise rumble strip designs, noise mitigation strategies, and the criteria for employing them.

There are three types of rumble strip functions: roadway, shoulder, and centerline, and each are described in the following sections.

1600.05(1)(a) Roadway Rumble Strips

Roadway rumble strips are placed transversely in the traveled way to alert drivers who are approaching a change of roadway condition or object that requires substantial speed reduction or other maneuvering. Some locations where advance roadway rumble strips may be placed include:

- Stop-controlled intersections
- Port of entry/customs stations
- Lane reductions where crash history shows a pattern of driver inattention, and
- Horizontal alignment changes where crash history shows a pattern of driver inattention.

They may also be placed at locations where the character of the roadway changes, such as at the end of a freeway.

Contact the HQ Design Office for additional guidance on the design and placement of roadway rumble strips.

Document decisions to use roadway rumble strips in the Design Documentation Package.

1600.05(1)(b) Shoulder Rumble Strips and Rumble Stripes

Shoulder rumble strips (SRS) are placed parallel to the traveled way just beyond the edge line to warn drivers they are entering a part of the roadway not intended for routine traffic use. Shoulder rumble stripes are rumble strips placed immediately under the shoulder delineation paint, with any excess width milled or placed outward towards the shoulder. Shoulder rumble stripes are only installed where there is insufficient space to install shoulder rumble strips per one of the standard configurations (see Section [1600.05\(1\)\(b\)\(2\)](#)).

When shoulder rumble strips and shoulder rumble stripes are used, discontinue them where no edge stripe is present, such as at intersections and where curb and gutter are present. Discontinue shoulder rumble strips and rumble stripes where shoulder driving is allowed.

Shoulder rumble strip and rumble stripe patterns vary depending on whether bicyclists are expected to use the highway shoulder, and whether they are placed on divided or undivided highways. Rumble strip patterns for undivided highways are shallower and may be narrower than patterns used on divided highways. Rumble strips and rumble stripes installed on undivided highways also provide gaps in the pattern, providing opportunities for bicycles to move across the pattern without having to ride across the grooves. There are four shoulder rumble strip and four shoulder rumble stripe patterns. Consult the [Standard Plans](#) (rumble strips) or [Plan Sheet Library](#) (rumble stripes) for patterns and construction details.

1. Divided Highways

Install shoulder rumble strips on both the right and left shoulders of rural Interstate highways. Consider them on both shoulders of rural divided highways. Use the Shoulder Rumble Strip or rumble stripe Type 1 pattern on divided highways.

Shoulder rumble strips and rumble stripes may be omitted under any of the following conditions:

- When another project scheduled within two years of the proposed project will overlay or reconstruct the shoulders or will use the shoulders for detours.
- When overall shoulder width is less than 4 feet wide on the left and 6 feet wide on the right. The minimum right shoulder width is reduced to 5 feet where rumble stripes are used.

2. Undivided Highways

Shoulder rumble strips or rumble stripes are considered on undivided highways during centerline rumble strip installation or pavement rehabilitation. A list of prospective locations are provided to regions by HQ Design as a starting point in their development of a final list. The final list is compiled based on a detailed review of the prospective locations using the following criteria. Document decisions to omit prospective locations in the final list.

Shoulder rumble strips or stripes may be omitted from a highway segment under any of the following conditions:

- Where at least 4 feet of usable shoulder between the rumble strip and the outside edge of shoulder cannot be provided. In cases where guardrail or barrier is present, increase this dimension to a minimum of 5 feet of usable shoulder. Field-verify these dimensions.
- Where downhill grades exceed 4% for more than 500 feet in length along routes where bicyclists are frequently present.
- Where sections of rumble strips are omitted as a measure to reduce noise (see Section [1600.05\(1\)](#)).

When selecting a rumble strip or rumble stripe design, consult the [Standard Plans](#) and [Plan Sheet Library](#) for the patterns and construction details, and apply the following criteria:

- Consider using a low noise pattern, or employ measures to reduce incidental contact, in areas where noise impacts are anticipated (apply criteria in Section [1600.05\(1\)](#)).
- Consider using a rumble stripe pattern where usable shoulder width is less than 4 feet (5 feet where barrier is present).

- The Shoulder Rumble Strip Type 2 or Type 3 pattern is used on highways with minimal bicycle traffic. Use the Shoulder Rumble Strip Type 4 pattern where the bicycle traffic level on the shoulder is determined to be high. Consult the region and Headquarters Bicycle and Pedestrian Coordinators to determine the bicycle traffic level, and engage them in decision-making processes related to the use of rumble strips or rumble stripes on bike touring routes, and/or on other routes where bicycle events are regularly held.

Document the decision to omit shoulder rumble strips or rumble stripes in a Design Analysis, when that decision is outside of the policy provided in this section (see [Chapter 300](#).)

1600.05(1)(c) Centerline Rumble Strips

Centerline rumble strips are installed on the centerline of undivided highways to alert drivers that they are entering the opposing lane. They are installed with no differentiation between passing permitted and no passing areas. Refresh pavement markings when removed by centerline rumble strips.

Centerline rumble strips are typically installed on rural highways where the posted speed is 45 mph or higher. They may also be installed on urban routes with posted speeds as low as 35 mph. A list of prospective centerline rumble strip installation locations are provided to regions by HQ Design as a starting point in their development of a final list. The final list is compiled based on a detailed review of the prospective locations using the following criteria.

- Field verify lane and shoulder widths. See [Chapter 1230](#) for guidance on lane and shoulder widths. Centerline rumble strips are only installed where the combined lane and shoulder width in either direction is greater than 12 feet.
- In locations where the combined lane and shoulder width in either direction is 14 feet or less, consider the level of bicyclist and pedestrian use along the route before installing centerline rumble strips. When drivers shift their lane position away from centerline to avoid the rumble strips, they are moving closer to pedestrians and bicyclists on the shoulder.
- Consider using a low noise rumble strip design in locations where noise is an issue, or employ measures for reducing incidental contact where a low noise design is not feasible (apply criteria in Section 1600.05(1)).
- In urban areas, do not consider installing rumble strips where the need to interrupt the rumble strip pattern to accommodate left-turning vehicles is very frequent, or where the posted speed is 35 mph and below.
- Do not use centerline rumble strips where two way left-turn lanes exist.

Document the decision to omit centerline rumble strips in a Design Analysis, when that decision is outside of the policy provided in this section (see [Chapter 300](#).)

1600.05(2) Headlight Glare Considerations

Headlight glare from opposing traffic is most common between opposing main line traffic. Glare screens can be used to mitigate this condition. Other conditions for which glare screen might be appropriate are:

- Between a highway and an adjacent frontage road, multi-use path, or parallel highway, especially where opposing headlights might seem to be on the wrong side of the driver.
- At an interchange where an on-ramp merges with a collector-distributor and the ramp traffic might be unable to distinguish between collector and main line traffic.
- Where headlight glare is a distraction to adjacent property owners. Playgrounds, ball fields, and parks with frequent nighttime activities might benefit from screening if headlight glare interferes with these activities.

Glare screening is normally not justifiable where the median width exceeds 20 feet, and the ADT is less than 20,000 vehicles per day. Document the decision to use glare screening using the following criteria:

- Higher frequency of night crashes compared to similar locations or based on statewide experience.
- Higher than normal ratio of night-to-day crashes.
- Unusual distribution or concentration of nighttime crashes.
- Over-representation of older drivers in night crashes.
- Combination of horizontal and vertical alignment, particularly where the roadway on the inside of a curve is higher than the roadway on the outside of the curve.
- Direct observation of glare.
- Public complaints concerning glare.

There are currently three basic types of glare screening available: chain link (see the [Standard Plans](#)), vertical blades, and concrete barrier (see [Exhibit 1600-8](#)).

When the glare is temporary (due to construction activity), consider traffic volumes, alignment, duration, presence of illumination, and type of construction activity. Glare screening may be used to reduce rubbernecking associated with construction activity, but less expensive methods, such as plywood that seals off the view of the construction area, might be more appropriate.

1600.06 Documentation

Refer to [Chapter 300](#) for design documentation requirements.

1600.07 References

1600.07(1) Federal/State Laws and Codes

[Revised Code of Washington \(RCW\) 47.24.020\(2\)](#), Jurisdiction, control

[RCW 47.32.130](#), Dangerous objects and structures as nuisances

1600.07(2) Design Guidance

Highway Safety Manual, AASHTO

[Local Agency Guidelines](#) (City and County Design Standards), M 36-63, WSDOT

Roadside Design Guide, AASHTO, 2011

Standard Plans for Road, Bridge, and Municipal Construction (Standard Plans), M 21-01, WSDOT

1600.07(3) Supporting Information

A Policy on Geometric Design of Highways and Streets (Green Book), AASHTO, 2011

Understanding Design Clear Zone – This e-learning course for WSDOT employees covers how to determine the appropriate Design Clear Zone for recoverable and nonrecoverable slopes as well as ditches. Request this training via the web-based Learning Management System.

Highways Over National Forest Lands, MOU, 2013, US Forest Service and WSDOT,
 www.wsdot.wa.gov/publications/manuals/m22-50.htm

Utilities Manual, M 22-87, WSDOT. Chapter 9 provides Control Zone guidance for utilities in the WSDOT right of way.

Exhibit 1600-2 Design Clear Zone Distance Table

Posted Speed (mph)	Average Daily Traffic	Cut Section (Backslope) (H:V)						Fill Section (H:V)					
		3:1	4:1	5:1	6:1	8:1	10:1	3:1	4:1	5:1	6:1	8:1	10:1
35 or Less		The Design Clear Zone Distance is 10 ft											
40	Under 250	10	10	10	10	10	10	*	13	12	11	11	10
	251 – 800	11	11	11	11	11	11	*	14	14	13	12	11
	801 – 2,000	12	12	12	12	12	12	*	16	15	14	13	12
	2,001 – 6,000	14	14	14	14	14	14	*	17	17	16	15	14
	Over 6,000	15	15	15	15	15	15	*	19	18	17	16	15
45	Under 250	11	11	11	11	11	11	*	16	14	13	12	11
	251 – 800	12	12	13	13	13	13	*	18	16	14	14	13
	801 – 2,000	13	13	14	14	14	14	*	20	17	16	15	14
	2,001 – 6,000	15	15	16	16	16	16	*	22	19	17	17	16
	Over 6,000	16	16	17	17	17	17	*	24	21	19	18	17
50	Under 250	11	12	13	13	13	13	*	19	16	15	13	13
	251 – 800	13	14	14	15	15	15	*	22	18	17	15	15
	801 – 2,000	14	15	16	17	17	17	*	24	20	18	17	17
	2,001 – 6,000	16	17	17	18	18	18	*	27	22	20	18	18
	Over 6,000	17	18	19	20	20	20	*	29	24	22	20	20
55	Under 250	12	14	15	16	16	17	*	25	21	19	17	17
	251 – 800	14	16	17	18	18	19	*	28	23	21	20	19
	801 – 2,000	15	17	19	20	20	21	*	31	26	23	22	21
	2,001 – 6,000	17	19	21	22	22	23	*	34	29	26	24	23
	Over 6,000	18	21	23	24	24	25	*	37	31	28	26	25
60	Under 250	13	16	17	18	19	19	*	30	25	23	21	20
	251 – 800	15	18	20	20	21	22	*	34	28	26	23	23
	801 – 2,000	17	20	22	22	23	24	*	37	31	28	26	25
	2,001 – 6,000	18	22	24	25	26	27	*	41	34	31	29	28
	Over 6,000	20	24	26	27	28	29	*	45	37	34	31	30
65	Under 250	15	18	19	20	21	21	*	33	27	25	23	22
	251 – 800	17	20	22	22	24	24	*	38	31	29	26	25
	801 – 2,000	19	22	24	25	26	27	*	41	34	31	29	28
	2,001 – 6,000	20	25	27	27	29	30	*	46	37	35	32	31
	Over 6,000	22	27	29	30	31	32	*	50	41	38	34	33
70	Under 250	16	19	21	21	23	23	*	36	29	27	25	24
	251 – 800	18	22	23	24	26	26	*	41	33	31	28	27
	801 – 2,000	20	24	26	27	28	29	*	45	37	34	31	30
	2,001 – 6,000	22	27	29	29	31	32	*	50	40	38	34	33
	Over 6,000	24	29	31	32	34	35	*	54	44	41	37	36

Notes:

This exhibit applies to:

- All state highways outside incorporated cities.
- Limited access state highways within cities.

For Roadside and Median areas on managed access state highways within incorporated cities, see [1600.02](#) for guidance. Curb is not considered adequate to redirect an errant vehicle.

Design Clear Zone distances are given in feet, measured from the edge of traveled way.

*When the fill section slope is steeper than 4H:1V, but not steeper than 3H:1V, the Design Clear Zone distance is modified by the recovery area formula (see [Exhibit 1600-4](#)) and is referred to as the recovery area. The basic philosophy behind the recovery area formula is that the vehicle can traverse these slopes but cannot recover (control steering); therefore, the horizontal distance of these slopes is added to the Design Clear Zone distance to form the recovery area. Provide a minimum of 10 feet at the toe of all traversable, non-recoverable fill slopes.

Exhibit 1600-3 Design Clear Zone Inventory Form

See: www.wsdot.wa.gov/design/support.htm for this form template in PDF, Word, or Excel spreadsheet. (PDF Shown Below) Remember, this form has 2 sides when copying.

Front sheet



Washington State Department of Transportation

Design Clear Zone Inventory

Region		SR		Control Section		MP	to MP		Date
Project Number		Project Title				Responsible Unit			
Item Number	MP to MP	Distance From Traveled Way		Description	Corrective Actions Considered (2)	Estimated Cost to Correct	Correction Planned (1)		
		L	R				Yes	No	

DOT Form 410-026 EF
Revised 4/05

(1) Only one "Yes" or "No" per item number. Corrections not planned must be explained on reverse side.
(2) A list of Location 1 & 2 Utility Objects to be forwarded to the region Utility Office for coordination per Control Zone Guidelines.

Back sheet

Item Number	Reasons for Not Taking Corrective Action

DOT Form 410-026 EF
Revised 4/05

Exhibit 1600-4 Recovery Area

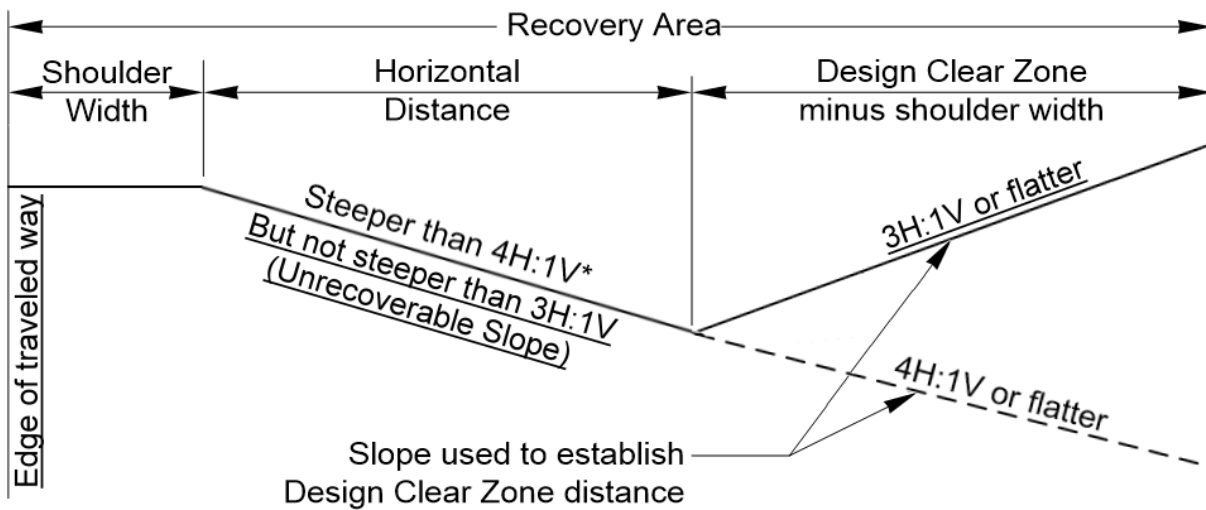

* When the fill section slope is steeper than 4H:1V, but not steeper than 3H:1V, the Design Clear Zone distance is modified by the recovery area formula (see Exhibit 1600-4) and is referred to as the recovery area. The basic philosophy behind the recovery area formula is that the vehicle can traverse these slopes but cannot recover and return to the roadway (control steering); therefore, the horizontal distance of these slopes is added to the Design Clear Zone distance to form the recovery area.

Formula:

Recovery area = (shoulder width) + (nonrecoverable slope distance) + the greater of [10 ft or (Design Clear Zone distance – shoulder width)]

Example: Fill section (fore slope 3H:1V and 6H:1V)**Conditions:**

Speed = 45 mph
 Traffic = 3,000 ADT
 Fore Slope = 3H:1V (Nonrecoverable)
 Fill Slope = 6H:1V = 17 ft from Exhibit 1600-2

Criteria:

Fore Slope 3H:1V → Use recovery area formula

Recovery area = (shoulder width (8 ft)) + (nonrecoverable slope distance (12 ft)) + Greater of (1) or (2):

(1) **10 ft**

(2) Design Clear Zone distance for 6H:1V (17 ft) – shoulder width (8 ft) = 9 ft

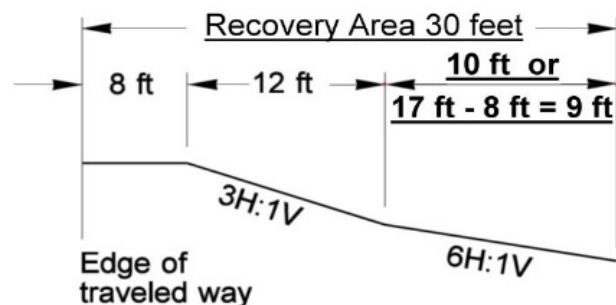

Recovery area = 20 + 10 ft = 30 feet

Exhibit 1600-5 Design Clear Zone Examples for Ditch Sections

Case 1: Cut section with ditch (foreslope 4H:1V of flatter)

Conditions:

- Speed = 55 mph
- Traffic = 4,200 ADT
- Slope = 4H:1V

Criteria:

- Greater of:
 - (1) Design Clear Zone for 10H:1V cut section, 23 ft
 - (2) 5 feet horizontal beyond beginning of back slope, 22 feet

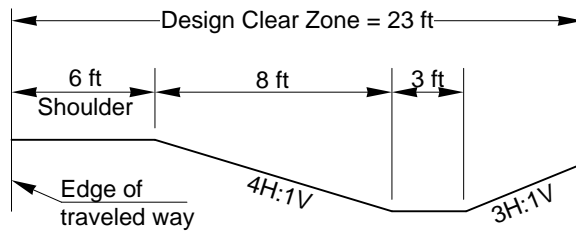

Design Clear Zone = 23 feet

Case 2: Cut section with ditch (foreslope steeper than 4H:1V and backslope steeper than 3H:1V)

Conditions: NA

Criteria: 10 feet horizontal beyond beginning of backslope

Design Clear Zone = 19 feet

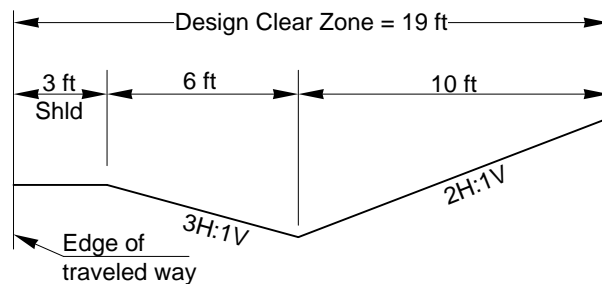

Case 3: Cut section with ditch (foreslope 3H:1V or steeper and backslope not steeper than 3H:1V)

Conditions:

- Speed = 45 mph
- Traffic = 3,000 ADT
- Foreslope = 2H:1V
- Backslope = 4H:1V

Criteria: Use recovery area formula

Recovery area = (shoulder width) + (horizontal distance) + (Design Clear Zone distance – shoulder width)

$$= 6 + 6 + (15 - 6) = 21$$

Recovery Area = 21 feet

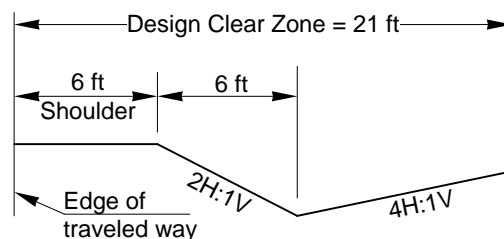
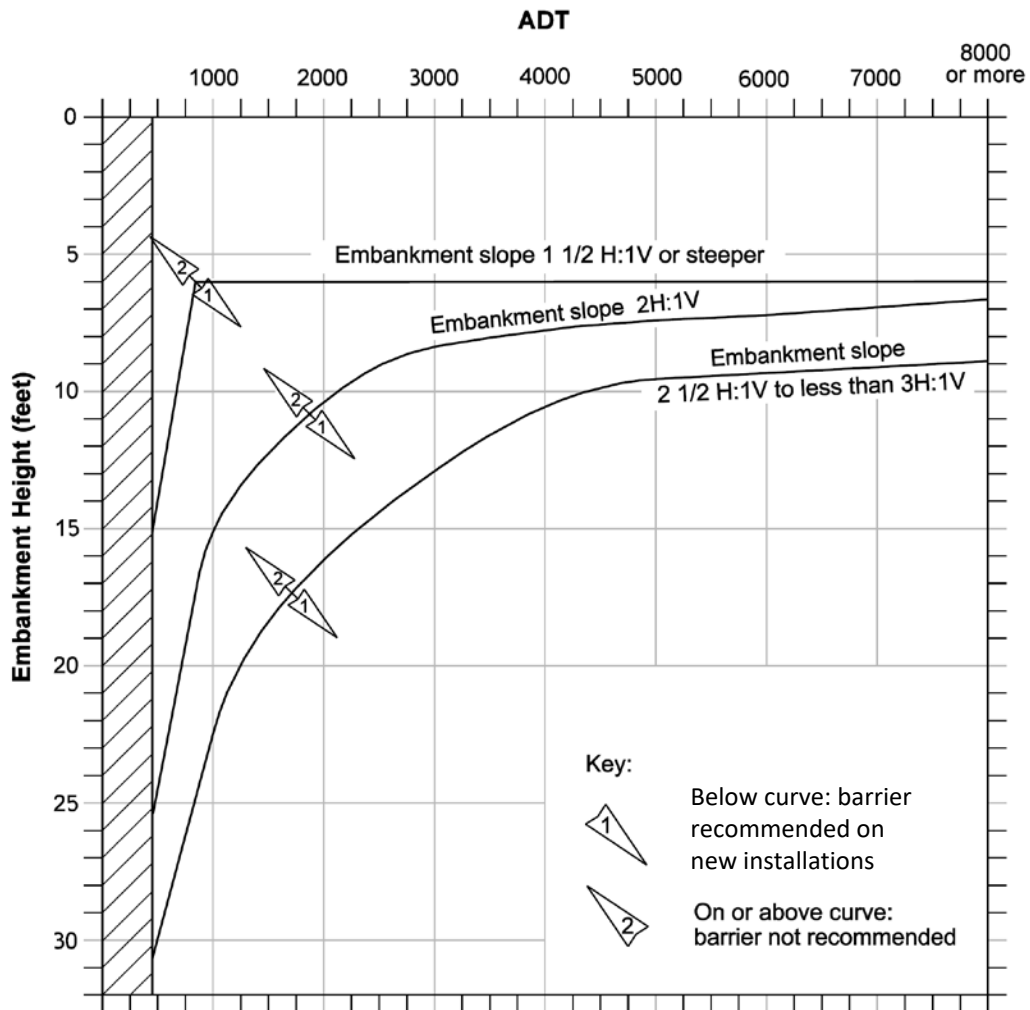

Exhibit 1600-6 Guidelines for Embankment Barrier



Note:

Routes with ADTs under 400 may be evaluated on a case-by-case basis.

Exhibit 1600-7 Mailbox Location and Turnout Design

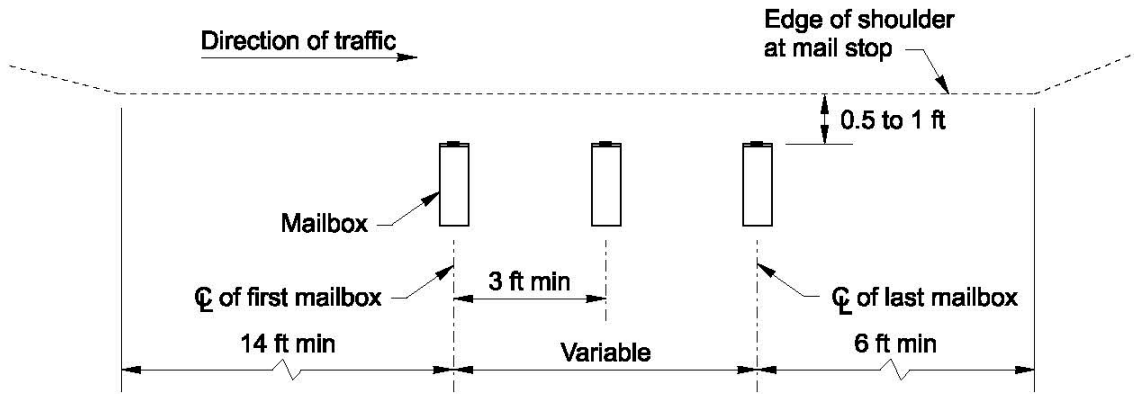
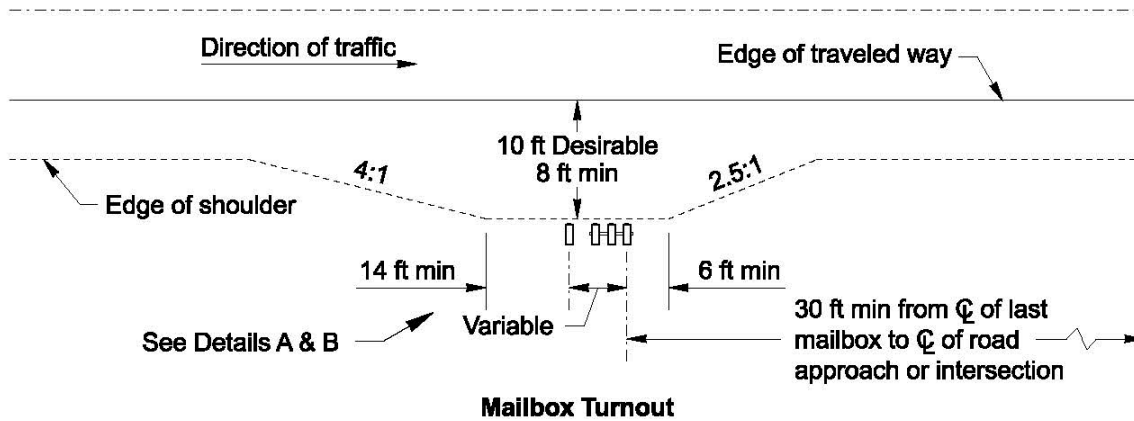

Mailbox Location: Single Box Design

Detail A

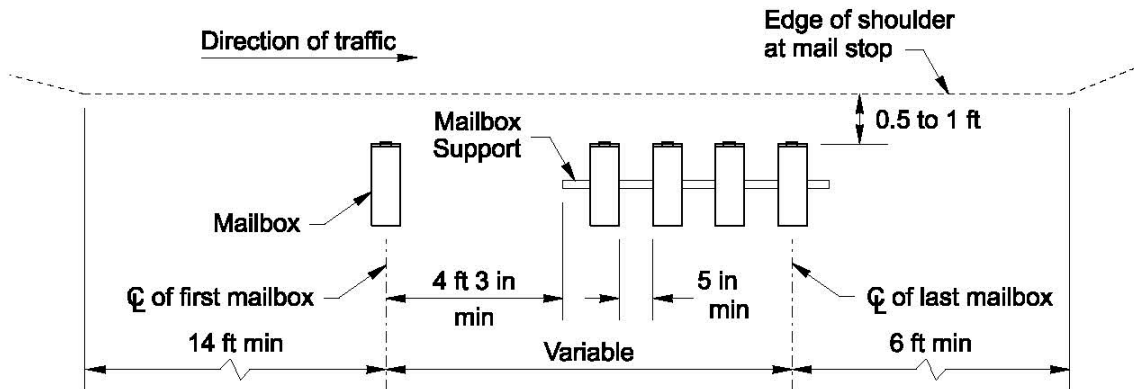

Mailbox Location: Multiple Box Design

Detail B

Exhibit 1600-8 Glare Screens

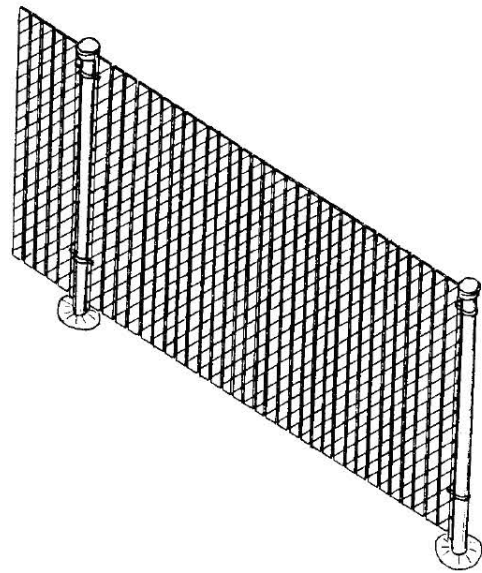
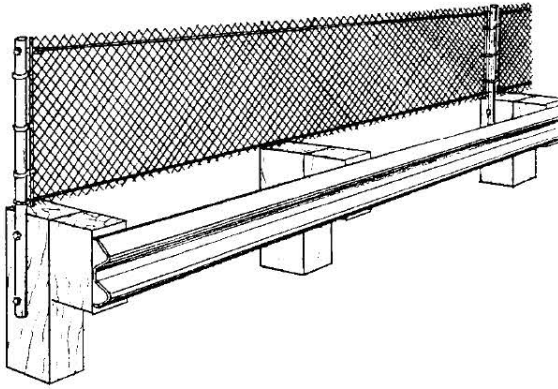

Chain Link

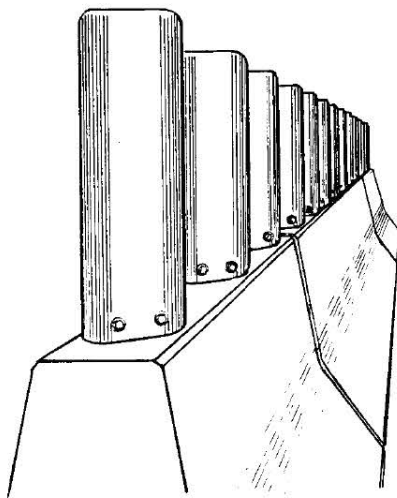

Vertical Blades

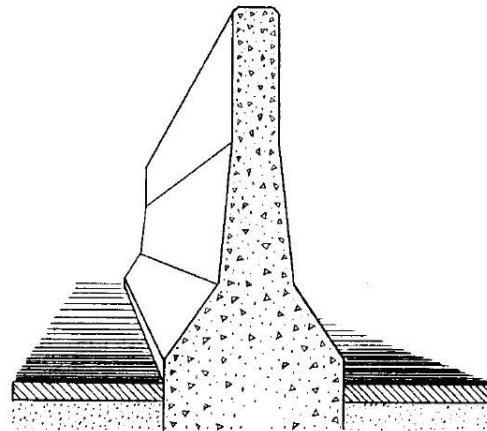

Concrete Barrier

1610.01	Introduction
1610.02	Barrier Impacts
1610.03	General Barrier Design Considerations
1610.04	Beam Guardrail
1610.05	High-Tension Cable Barrier
1610.06	Concrete Barrier
1610.07	Bridge Traffic Barriers
1610.08	Other Barriers
1610.09	References

Chapter Organization: The first sections (Introduction and Barrier Impacts) present information to consider when deciding whether to install a barrier. The next section (General Barrier Design Considerations) contains guidance common to ALL barrier types, such as deflection distance, length of need and sight distance. The remaining sections present design information organized by specific barrier type (beam guardrail, cable barrier, etc.).

Refer to the *Design Manual Glossary* for many of the terms used in this chapter.

Refer to [Chapter 300](#) for design documentation requirements.

1610.01 Introduction

WSDOT uses traffic barriers to reduce the overall severity of crashes. Consideration is given as to whether a barrier is preferable to the recovery area it may replace. In some cases, installation of a traffic barrier may result in more crashes as it presents an object that can be struck. Barriers are designed so that such encounters might be less severe and not lead to secondary or tertiary crashes. However, traffic barriers are not guaranteed to redirect an impacting vehicle without resulting injury to its occupants or triggering additional crashes. Barrier performance is affected by the characteristics of the vehicles that collide with them. Different vehicles will react differently given the characteristics and dynamics of the crash. Therefore, vehicles will be decelerated and redirected differently given the size, weight and direction of force imparted from the vehicle to the barrier.

Barriers are not placed with the assumption that the system will restrain or redirect all vehicles in all conditions. It is recognized that the designer cannot design a system that will address every potential crash situation. Instead, barriers are placed with the assumption that, under typical crash conditions, they might decrease the potential for excessive vehicular deceleration or excessive vehicle redirection when compared to the location without the barrier.

Traffic barriers do not prevent crashes or injuries from occurring. They often lower the potential severity for crash outcomes. Consequently, barriers should not be used unless a reduced crash severity potential is likely. No matter how well a barrier system is designed, optimal performance is dependent on drivers' proper maintenance and operation of their vehicles and the proper use of passenger restraint systems. The ultimate choice of barrier type and placement should be made by gaining an understanding of site and traffic conditions, having a thorough understanding of and applying the criteria presented in Chapters [1600](#) and [1610](#), and using engineering judgment.

Barrier systems and vehicle fleets continue to evolve. The choice of a barrier is based on the characteristics of today's vehicle fleet and testing criteria, not on speculative assumptions of future vehicle designs. This continuum of change does not allow engineers to predict the future with any degree of certainty. Consequently, engineering decisions need to be made based on the most reliable and current information.

Engineers are constantly striving to develop more effective design features to improve highway safety. However, economics, asset management and maintenance needs, and feasibility do not permit the deployment of new designs as soon as they become available on the market or are invented by a manufacturer. Further, most new designs only make marginal changes to systems and do not imply that old designs are unsafe or need modification.

Solutions may consider crash frequency and severity. As discussed previously, performance of the system relies on the interaction of the vehicle, driver, and system design at any given location. Additionally, the ability to safely access, maintain and operate over time is incorporated into the final barrier decision.

When barriers are crash-tested, it is impossible to replicate the innumerable variations in highway conditions under which the barrier applications occur. Therefore, barriers are crash-tested under standardized conditions. These standard conditions were previously documented in National Cooperative Highway Research Program (NCHRP) Reports 230 and 350. These guidelines have been updated and are now presented in the AASHTO publication, *Manual for Assessing Safety Hardware* (MASH).

As roadside safety hardware changes occur on the highway system they will use MASH crash testing criteria instead of NCHRP Report 350. To learn more about WSDOT's plan for implementing MASH-compliant hardware see the following website:

🔗 <http://www.wsdot.wa.gov/Design/Policy/RoadsideSafety.htm>

1610.01(1) Site Constraints

Site constraints play a major role in decisions regarding guardrail selection and placement. Depending on the location, these constraints may include (but are not limited to) environmental considerations, topographic challenges, restricted right-of-way, geologic concerns or conflicts with other infrastructure to name just a few. Document barrier location decisions, including any site constraints encountered that influenced those decisions. A decision to install barrier using criteria outside the guidance provided in this chapter requires a Design Analysis (See [Chapter 300](#)).

1610.02 Barrier Impacts

Engineering judgment is required in determining the appropriate placement of barrier systems, therefore consider the location of the system and the possible impacts the barrier may have to other highway objectives.

1610.02(1) Assessing Impacts to Stormwater and Wetlands

The presence of stormwater facilities or wetlands influence the choice and use of barrier systems. For example, the placement of concrete barrier may increase the amount of impervious surface, which could then result in retrofit or reconstruction of the existing retention/detention systems and environmental impact requirements and studies. Assess

whether concrete barrier or beam guardrail placement will cause the need for an evaluation by the HQ Environmental Services Office. Conduct this evaluation early in the project's development process to allow adequate time for discussion of options.

1610.02(2) Assessing Impacts to Wildlife

The placement of concrete barriers in locations where wildlife frequently cross the highway can influence wildlife-vehicle crash potential. When wildlife encounters physical barriers that are difficult to see beyond or cross, such as concrete barriers, they often stop or move parallel to those barriers, increasing their time on the highway and their exposure.

Traffic-related wildlife mortality may play a role in the decline of some species listed under the Endangered Species Act. To address wildlife concerns, see Exhibit 1610-1 to assess whether barrier placement needs to have an evaluation by the HQ Environmental Services Office to determine its effect on wildlife. Conduct this evaluation early in the project development process to allow adequate time for discussion of options.

Exhibit 1610-1 Concrete Barrier Placement Guidance: Assessing Impacts to Wildlife

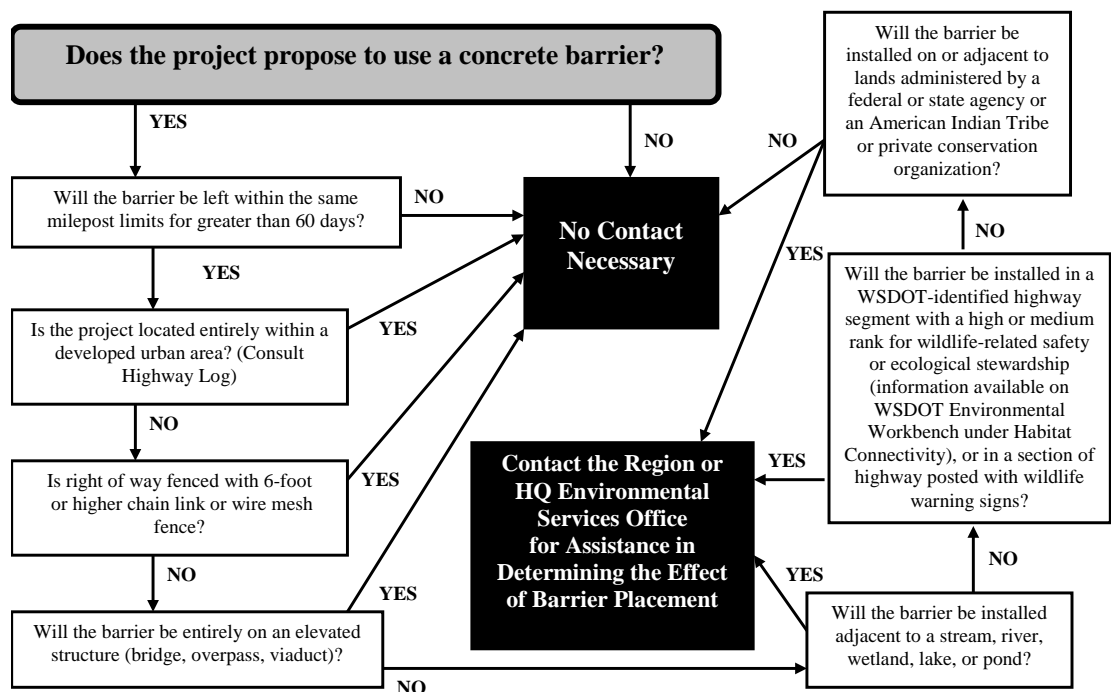

1610.03 General Barrier Design Considerations

See [Chapter 1105](#) Design Element Selection for guidance regarding required design elements for the various different project types (programs and subprograms).

[Chapter 1120](#) identifies those elements and features to be evaluated and potentially addressed during the course of a Preservation project.

Follow the guidance in this chapter for any project that introduces new barrier onto the roadside (including median section) and follow the guidance in [Chapter 1600](#) for removal of barrier that is not needed. Slope flattening is recommended when the crash reduction benefit justifies the additional cost to eliminate the need for barrier.

When selecting a barrier, consider the barrier system's deflection characteristics, cost, maintainability and impacts to traffic flow during repair. Barriers are categorized as flexible, semi-rigid, or rigid depending on their deflection characteristics. (See [Exhibit 1610-3](#)). Barrier types include:

- Beam Guardrail
- Cable Barrier
- Concrete Barrier
- Bridge Traffic Barrier
- Other Barriers

Since non-rigid systems typically sustain more damage during an impact, consider the amount of traffic exposure maintenance crews might incur with the more frequent need for repairs.

The costs for procuring and maintaining the barrier system are important factors when considering what system to install. Considerations may include:

- Consultation with the Area Maintenance Superintendent to identify needs or recommendations.
- Drainage, alignment, and drifting snow or sand are considerations that can influence the selection of barrier type. Beam guardrail and concrete barrier can contribute to snow drifts. Consider long-term maintenance costs associated with snow removal at locations prone to snow drifting. Cable barrier is not an obstruction to drifting snow.
- Analysis of potential reduction of sight distance due to barrier selection and placement.
- Additional widening and earthwork requirements. With some systems, such as concrete barrier and beam guardrail, the need for additional shoulder widening or slope flattening is common. Selection of these types of barriers may require substantial environmental permitting or roadway reconstruction. Permits issued under the SEPA and NEPA processes may lead to the use of a barrier design, such as cable barrier, which has fewer potential environmental impacts and costs.
- For concrete barrier systems:
 - Lower maintenance costs than for other barrier types.
 - Deterioration due to weather and vehicle impacts is less than most other barrier systems.
 - Unanchored precast concrete barrier can usually be realigned or repaired after a vehicle impact. However, heavy equipment may be necessary to reposition or

replace barrier segments. Therefore, in medians, consider the shoulder width and the traffic volume when determining the acceptability of unanchored precast concrete barrier versus rigid concrete barrier. See [Exhibit 1610-3](#) for deflection area requirements.

Consider the following for existing barrier systems:

- Install, replace, or modify transitions as discussed in [1610.04\(6\)](#) Transitions and Connections.
- When installing new terminals, extend the guardrail to meet the length-of-need criteria found in [1610.03\(5\)](#).
- When replacing damaged terminals, consider extending the guardrail to meet the length of need criteria in [1610.03\(5\)](#)
- When the end of a barrier has been terminated with a small mound of earth, remove and replace with a terminal as described in [1610.06\(3\)](#).
- Special use or aesthetic barriers may be used on designated Scenic Byway and Heritage Tour routes if funding, permits, and approvals can be arranged (see [1610.08](#)).
- Design Manual [Chapter 1120](#) identifies specific requirements to be addressed for a Preservation project. For other projects, address barrier runs that include:
 - W-beam guardrail with 12-foot 6-inch post spacing, or no blockouts, or both.
 - W-beam guardrail on concrete posts.
 - Cable barrier on wood or concrete posts.
 - Half-moon or C-shaped rail elements.

1610.03(1) Barrier Placement Considerations

Proper installation of a barrier system is required for the system to perform similar to the crash tests that resulted in its acceptance for use on our highways. Maximize the distance between the barrier and the travelled way.

See [Chapter 1239](#) for minimum lateral clearance requirements.

1610.03(1)(a) Placement on a Slope

Slopes may affect barrier placement. Considerations for barrier placement on a slope include:

- For slopes that are 10:1 or flatter, concrete barrier, beam guardrail or cable barrier can be installed anywhere beyond the edge of shoulder. See [Exhibit 1610-2](#).
- For additional placement guidance see [1610.05\(1\)](#) for cable barrier, see [1610.04\(2\)](#) for beam guardrail, and see [1610.06](#) for concrete barrier.

Exhibit 1610-2 Traffic Barrier Locations on Slopes

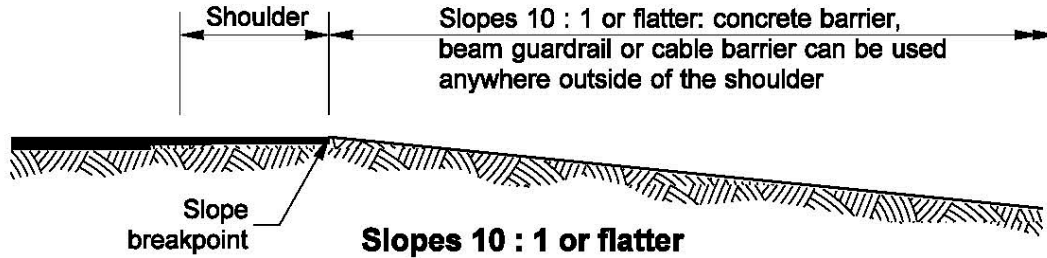

1610.03(1)(b) Placement in Median Locations

Considerations for barrier placement in a median include:

- Address the design deflection characteristics of the barrier to avoid placement of barrier where the design deflection extends into oncoming traffic.
- Narrow medians provide little space for any maintenance activities, including repair or repositioning of the barrier. Installing barriers in medians that provide less than 8 feet from the edge of the traveled way to the face of the barrier will likely require temporarily closing the adjacent lane during maintenance activities. This will impact the travelling public and impact maintenance staff, and maintenance staff should be consulted. See [Chapter 301](#) Design and Maintenance Coordination.
- At locations where the roadways are on independent alignments and there is a difference in elevation between the roadways, the slope from the upper roadway might be steeper than 6H:1V. In these locations, position the median barrier along the upper roadway and provide deflection and offset distance as discussed previously. Barrier is generally not needed along the lower roadway except where there are fixed features in the median.
- In wider medians, the selection and placement of barrier might depend on the slopes in the median. At locations where the median slopes are relatively flat (10H:1V or flatter), unrestrained precast concrete barrier, beam guardrail, and cable barrier can be used depending on the available deflection distance. At these locations, position the barrier as close to the center of the median as possible so that the recovery distance can be maximized for both directions. There may be a need to offset the barrier from the flow line to avoid impacts to the drainage flow.
- In general, cable barrier is recommended with medians that are 30 feet or wider. However, cable barrier may be appropriate for narrower medians if adequate deflection distance exists.
- When W-beam barrier is placed in a median as a countermeasure for cross-median crashes, design the barrier to be struck from either direction of travel. For example, the installation of beam guardrail might be double-sided (Type 31-DS).
- For additional placement guidance see [1610.05\(1\)](#) for cable barrier, see [1610.04\(2\)](#) for beam guardrail, and see [1610.06](#) for concrete barrier.

1610.03(2) Sight Distance

When selecting and placing a barrier system, consider the possible impact the barrier type and height may have on sight distance. In some cases, barriers may restrict the sight distances of road users entering the roadway, such as from road approaches, intersections, and other locations. In these cases, the barrier may need to be adjusted to meet the sight distance requirements at these locations.

1610.03(3) Barrier Deflections

Expect all barriers, except rigid barriers (such as concrete bridge rails, barrier integral to retaining walls, or embedded cast-in-place barriers), to deflect when hit by an errant vehicle. The amount of deflection is primarily dependent on the stiffness of the system. However, vehicle speed, angle of impact, and weight of the vehicle also affect the amount of barrier deflection. For flexible and semi-rigid roadside barriers, the deflection distance is designed to prevent the impacting vehicle from striking the object being shielded. For unrestrained rigid systems (unanchored precast concrete barrier), the deflection distance is designed to help prevent the barrier from being knocked over the side of a drop-off or steep fill slope (2H:1V or steeper).

In median installations, design systems such that the anticipated deflection will not enter the lane of opposing traffic. When evaluating new barrier installations, consider whether impacts would require significant traffic closures to accomplish maintenance. Use a rigid system where deflection cannot be accommodated, such as in narrow medians or at the edge of bridge decks or other vertical drop-off areas. Runs of rigid concrete barrier can be cast in place or extruded with appropriate footings.

In some locations, where deflection distance is limited, anchor precast concrete barrier. Unless the anchoring system has been designed to function as a fully rigid barrier, some movement can be expected and repairs may be more expensive. Use of an anchored or other deflecting barrier on top of a retaining wall without deflection distance provided requires approval from the HQ Design Office. See [1610.06](#) for more information on concrete barrier.

Refer to [Exhibit 1610-3](#) for barrier deflection design values when selecting a longitudinal barrier. The deflection values for cable and beam guardrail are minimum distances, measured between the face of the barrier to the fixed feature. The deflection values for unanchored concrete barrier are minimum distances, measured from the back edge of the barrier to the fixed feature, drop-off or slope break.

Exhibit 1610-3 Longitudinal Barrier Deflection

Barrier Type	System Type	Deflection Distance
High-tension cable barrier	Flexible	6 ft to 10 ft typical [1] (face of barrier to object)
Beam guardrail, Types 1, 1a, 2, and 10	Semi-rigid	3 ft [4] (face of barrier to object)
Beam guardrail, two-sided Types 3, and 4	Semi-rigid	4 ft (nearest face of barrier to object)
Beam guardrail Type 31 (including two-sided and omitted post)	Semi-rigid	5 ft (face of barrier to object)
Permanent concrete barrier, unanchored	Rigid Unrestrained	3 ft [2] (back of barrier to object)
Temporary concrete barrier, unanchored	Rigid Unrestrained	2 ft [3] (back of barrier to object)
Precast concrete barrier, anchored	Rigid Anchored	6 inches
Rigid concrete barrier	Rigid	No deflection
Notes:		
[1] See 1610.05(2)		
[2] When placed in front of a 2H:1V or flatter fill slope, the deflection distance can be reduced to 2 feet.		
[3] When used as temporary bridge rail, anchor all barrier within 3 feet of a drop-off.		
[4] Place any new objects a minimum of 5 feet from the face of existing beam guardrail type 1.		

1610.03(4) Flare Rate

A roadside barrier is considered flared when it is not parallel to the edge of the traveled way.

Flare the ends of longitudinal barriers where site constraints allow (see [1610.01\(1\)](#)). The four functions of a flare are to:

- Maximize the distance between the barrier (and its terminal) and the travelled way.
- Reduce the length of need.
- Redirect an errant vehicle.
- Minimize a driver's reaction to the introduction of an object near the traveled way.

Keeping flare rates as flat as site constraints allow preserves the barrier's redirection performance and minimizes the angle of impact. It has also been shown that an object (or barrier) close to the traveled way might cause a driver to shift laterally, slow down, or both. The flare reduces this reaction by gradually introducing the barrier so the driver does not perceive the barrier as an object to be avoided. The flare rates in [Exhibit 1610-4](#) are intended to satisfy the four functions listed above. Flares that are more gradual may be used. Flare rates are offset parallel to the edge of the traveled way. Transition sections are not flared.

Situations exist where hardware installations may have barrier flare rates different than shown in Exhibit 1610-4. If a *Standard Plan* for a barrier installation shows a different flare rate than is shown in Exhibit 1610-4, the flare rate shown on the *Standard Plan* can be used.

Exhibit 1610-4 Longitudinal Barrier Flare Rates

Posted Speed (mph)	Rigid & Rigid Anchored System	Unrestrained Rigid System	Semi-rigid
65–70	20:1	18:1	15:1
60	18:1	16:1	14:1
55	16:1	14:1	12:1
50	14:1	12:1	11:1
45	12:1	11:1	10:1
40 or below	11:1	10:1	9:1

1610.03(5) Length of Need

Length of need refers to the total length of longitudinal barrier needed to shield a fixed feature.

In many cases, there may be a portion of the traffic barrier installation that is not redirective in capability. For instance, if a run of concrete barrier is terminated with an impact attenuator, there will likely be a section of the impact attenuator that is not redirective (see [Chapter 1620](#) for more information). Therefore, in most cases, the Length of Need does not equal (i.e., it is shorter than) the actual physical length of the traffic barrier installation required to achieve that length of need.

Length of need is dependent on the location and geometrics of the object, direction(s) of traffic, posted speed, motor vehicle traffic volume, and type and location of traffic barrier.

When designing a barrier for a fill slope (see [Chapter 1600](#)), the length of need begins at the point where the need for barrier is recommended. For fixed objects and water, [Exhibit 1610-5](#) shows design parameters for determining the needed length of a barrier for both adjacent and opposing traffic on relatively straight sections of highway.

When barrier is to be installed on the outside of a horizontal curve, the length of need can be determined graphically as shown in [Exhibit 1610-7](#). For installations on the inside of a curve, determine the length of need as though it were straight. Also, consider the flare rate, barrier deflection, and barrier end treatment to be used.

When beam guardrail is placed in a median, consider the potential for impact from opposing traffic when conducting a length of need analysis. When guardrail is placed on either side of objects in the median, consider whether the trailing end of each run of guardrail will shield the leading end of the opposing guardrail. Shield the leading end when it is within the Design Clear Zone of opposing traffic (see [Exhibit 1610-8](#)). This is also a consideration when objects are placed in the outer separations between the main line and collector-distributors.

Before the actual length of need is determined, establish the lateral distance between the proposed barrier installation and the object shielded. Provide a distance that is greater than or equal to the anticipated deflection of the longitudinal barrier. (See [Exhibit 1610-3](#) for barrier deflections.) Place the barrier as far from the edge of the traveled way as possible while maintaining the deflection distance.

If the end of the length of need is near an adequate cut slope, extend the barrier and embed it in the slope (see [1610.04\(5\)](#)). Avoid gaps of 300 feet or less. Short gaps are acceptable when the barrier is terminated in a cut slope. If the end of the length of need is near the end of an existing barrier, it is recommended that the barriers be connected to form a continuous barrier. Consider maintenance access issues when determining whether or not to connect barriers.

Exhibit 1610-5 Barrier Length of Need on Tangent Sections

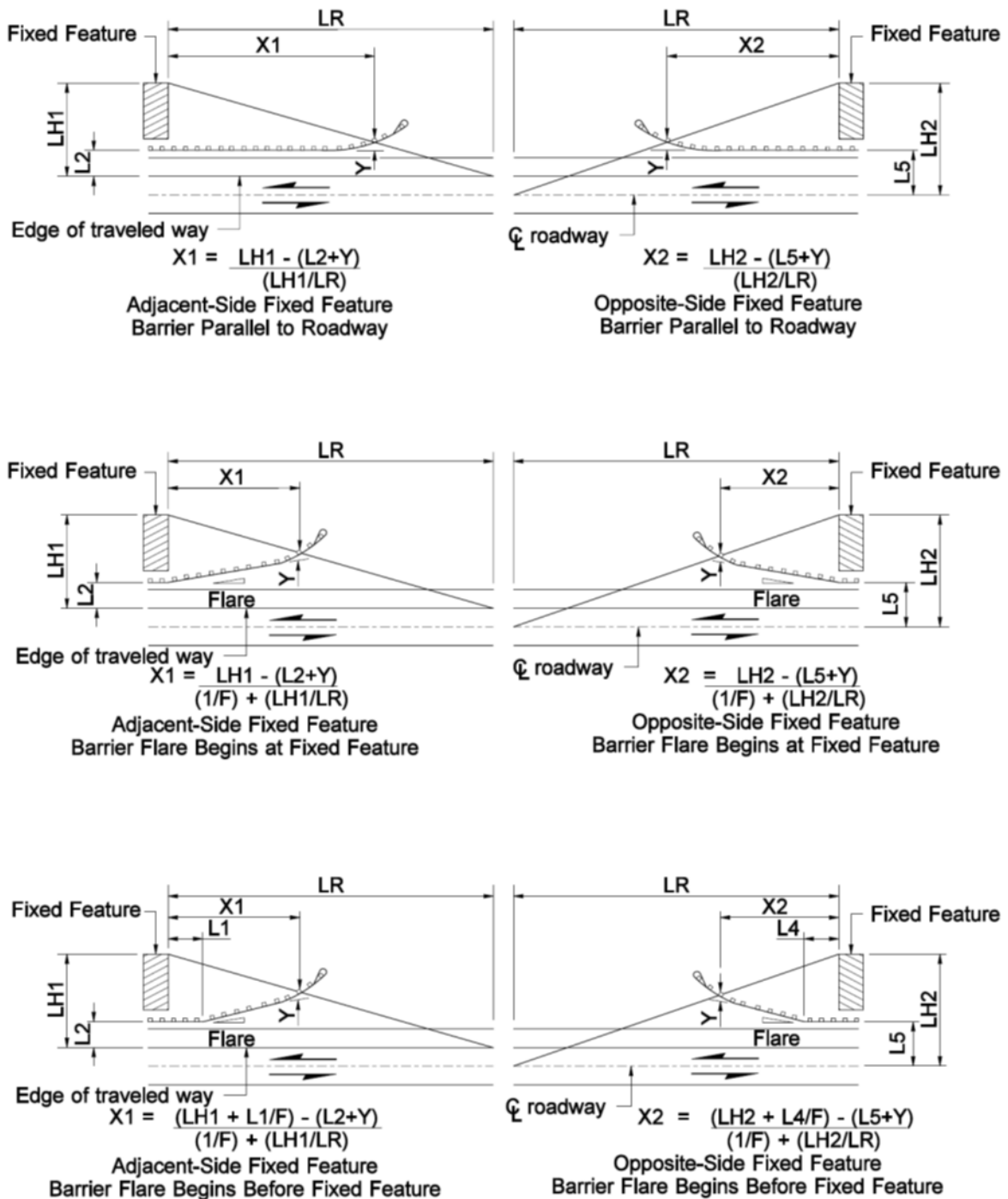

Note: For supporting length of need equation factors, see Exhibit 1610-6

Exhibit 1610-6 Barrier Length of Need

Posted Speed (mph)	Design Parameters						
	ADT				Barrier Type		
	Over 10,000	5,000 to 10,00	1,000 to 4,999	Under 1,000	Rigid & Rigid Anchored Barrier	Rigid Unrestrained Barrier	Semi-rigid Barrier
	LR (ft)	LR (ft)	LR (ft)	LR (ft)	F	F	F
70	360	330	290	250	20	18	15
65	330	290	250	225	20	18	15
60	300	250	210	200	18	16	14
55	265	220	185	175	16	14	12
50	230	190	160	150	14	12	11
45	195	160	135	125	12	11	10
40	160	130	110	100	11	10	9
35	135	110	95	85	11	10	9
30	110	90	80	70	11	10	9
25	110	90	80	70	11	10	9

L1 = Length of barrier parallel to roadway from adjacent-side fixed feature to beginning of barrier flare. This is used if a portion of the barrier cannot be flared (such as a bridge rail and the transition).

L2 = Distance from adjacent edge of traveled way to portion of barrier parallel to roadway.

L4 = Length of barrier parallel to roadway from opposite-side fixed feature to beginning of barrier flare.

L5 = Distance from centerline of roadway to portion of barrier parallel to roadway. **Note:** If the fixed feature is outside the Design Clear Zone when measured from the centerline, it may only be necessary to provide a crash-tested end treatment for the barrier.

LH1 = Distance from outside edge of traveled way to back side of adjacent-side fixed feature. **Note:** If a fixed feature extends past the Design Clear Zone, the Design Clear Zone can be used as LH1.

LH2 = Distance from centerline of roadway to back side of opposite-side fixed feature. **Note:** If a fixed feature extends past the Design Clear Zone, the Design Clear Zone can be used as LH2.

LR = Runout length, measured parallel to roadway.

X1 = Length of need for barrier to shield an adjacent-side fixed feature.

X2 = Length of need for barrier to shield an opposite-side fixed feature.

F = Flare rate value.

Y = Offset distance needed at the beginning of the length of need.

Different end treatments need different offsets:

- For the SRT 350 and FLEAT 350, use Y = 1.8 feet.
- For evaluating existing BCTs, use Y = 1.8 feet.
- For the FLEAT TL-2, use Y = 0.8 feet.
- No offset is needed for the non-flared terminals or impact attenuator systems. Use Y = 0.

Exhibit 1610-7 Barrier Length of Need on Curves

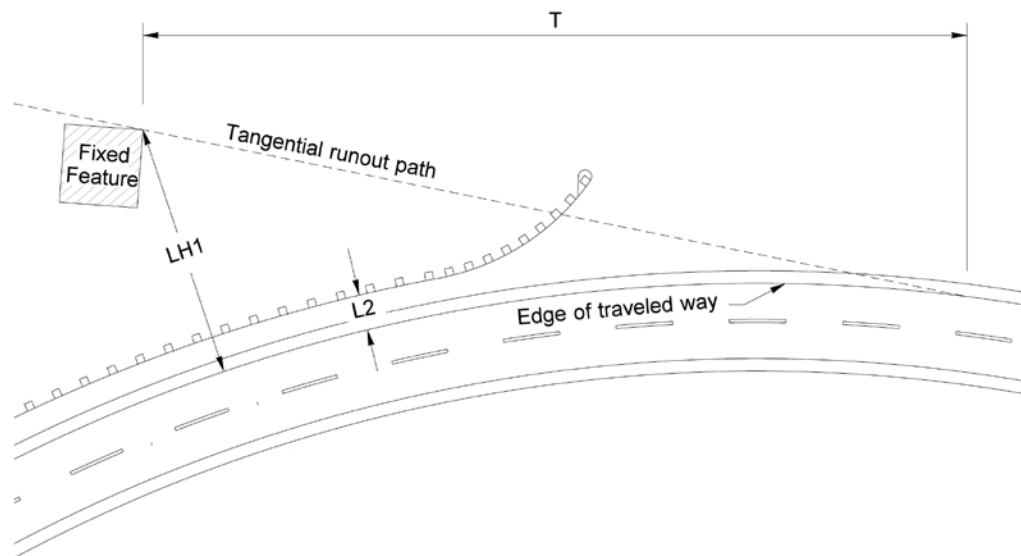

Notes:

- This is a graphical method for determining the length of need for barrier on the outside of a curve.
- On a scale drawing, draw a tangent from the curve to the back of the fixed feature. Compare T to LR from [Exhibit 1610-6](#) and use the shorter value.
- If using LR, follow [Exhibits 1610-5](#) and [6](#).
- If using T, draw the intersecting barrier run to scale and measure the length of need.

Exhibit 1610-8 W-Beam Guardrail Trailing End Placement for Divided Highways

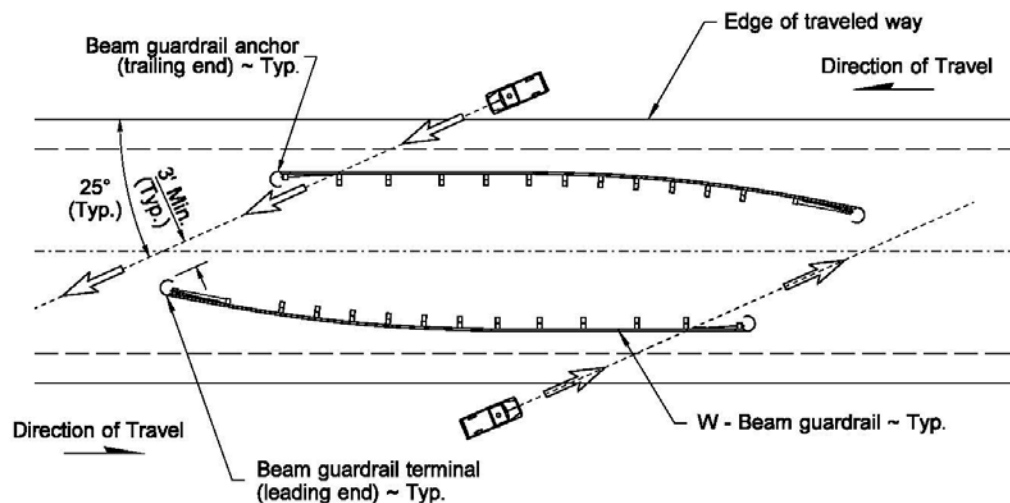

1610.03(6) **Barrier Delineation**

Refer to [Chapter 1030](#) for barrier delineation requirements.

1610.04 **Beam Guardrail**

Strong post W-beam guardrail and three beam guardrail are semi-rigid barriers used predominantly on roadsides. They have limited application as median barrier. A strong-post W-beam (commonly referred to as W-Beam) guardrail system is the most common type of guardrail system used. The design uses wood or steel posts, rail, and blockouts to support the rail away from the post. The system resists a vehicle impact through a combination of the tensile and flexural stiffness of the rail and the bending or shearing resistance of the post.

Installed incorrectly, strong post W-beam guardrail can cause vehicle snagging or spearing. This can be avoided by lapping the rail splices in the direction of traffic (as shown in the [Standard Plans](#)), by using crash-tested end treatments, and by blocking the rail away from the posts.

Beam guardrail systems are shown in the [Standard Plans](#).

1610.04(1) **Beam Guardrail Systems**

1610.04(1)(a) **Type 31 Beam Guardrail**

Use Type 31 guardrail for new installations. The Type 31 system uses many of the same components as the old WSDOT Type 1 system. The main differences are that the blockouts extend 12 inches from the posts, the rail height is 31 inches from the ground to the top of the rail, the deflection requirements are 2 feet greater, and the rail elements are spliced between posts.

Type 31 guardrail offers tolerance for future HMA overlays. The system allows a 3-inch tolerance from 31 inches to 28 inches without adjustment of the rail element.

Type 31 guardrail is available double-sided, which can be used in medians.

1610.04(1)(b) **(Old) Type 1 Beam Guardrail**

Previous WSDOT standard practice was to install W-beam guardrail at a rail height of 27 to 28 inches, and is referred to as “Type 1” guardrail. WSDOT is phasing out the use of Type 1 guardrail. Do not use Type 1 guardrail for new installations, except when the Type 1 guardrail weak post system is the best choice at an intersection due to site constraints (see 1610.04(7)(a)). Place new objects a minimum of 5 feet behind the face of existing beam guardrail type 1. For more information on (Old) Beam Guardrail Type 1, see:

<http://www.wsdot.wa.gov/Design/Policy/RoadsideSafety.htm>.

Existing runs of Type 1 guardrail are acceptable to leave in place. If an existing run of Type 1 guardrail requires extending, use the Beam Guardrail Type 31 to Beam Guardrail Type 1 Adaptor shown in the [Standard Plans](#), and complete the guardrail extension using Type 31 guardrail.

1610.04(1)(c) **Other Guardrail Types**

W-beam guardrail Type 2 and Type 3 have a height of 30 inches and utilize a rubrail. A rubrail is a structural steel channel added below the W-beam rail and is used in these specific designs to reduce vehicle snagging on the post. Existing runs of Type 2 or Type 3 guardrail are acceptable

to leave in place. If the existing run of Type 2 or 3 requires extending contact WSDOT Design Office to identify appropriate extension methods.

Type 4 guardrail is a double-sided version of the Type 1 guardrail system. For new installation, use the Type 31 double-sided w-beam guardrail instead of Type 4 guardrail. Existing runs of Type 4 guardrail are acceptable to leave in place. If the existing run of Type 4 requires extending contact WSDOT Design Office to identify appropriate extension methods to transition to the Type 31 double-sided system.

Type 10 and Type 11 are three-beam guardrail systems. Existing runs of Type 10 or 11 guardrail are acceptable to leave in place. If an existing run of Type 10 or Type 11 guardrail requires extending, contact the WSDOT Design Office to discuss options.

Weak post W-beam guardrail (Type 20) and three beam guardrail (Type 21) are flexible barrier systems primarily used in conjunction with a Service Level 1 bridge rail system for bridges with timber decks. These systems use weak steel posts. For information on Type 20 and Type 21 guardrail see: <http://www.wsdot.wa.gov/Design/Policy/RoadsideSafety.htm>

1610.04(2) Beam Guardrail Placement

There are a number of considerations regarding guardrail placement. These include:

- During the project development processes, consult with maintenance staff to help identify guardrail runs that may need to be modified.
- When guardrail is installed along existing shoulders with a width greater than 4 feet, the shoulder width may be reduced by 4 inches to accommodate the 12-inch blockout. A Design Analysis is not required for the reduced shoulder width. If the remaining shoulder width is 4 feet or less, see [Chapter 1030](#) for barrier delineation guidance.
- Keep the slope of the area between the edge of the shoulder and the face of the guardrail 10H:1V or flatter.
- On fill slopes 10:1 or flatter, beam guardrail can be placed anywhere outside of the shoulder.
- On fill slopes between 6H:1V and 10H:1V, place beam guardrail at the shoulder or at least 12 feet from the slope breakpoint (as shown in Exhibit 1610-9).
- Do not place beam guardrail on a fill slope steeper than 6H:1V
- On the high side of superelevated sections, place beam guardrail at the edge of shoulder prior to the slope breakpoint.
- For W-beam guardrail installed at or near the shoulder, 2 feet of shoulder widening behind the barrier is generally provided from the back of the post to the slope breakpoint of a fill slope (see [Exhibit 1610-10](#), Case 2). If the slope is 2H:1V or flatter, this distance can be 2.5 feet measured from the face of the guardrail rather than the back of the post (see [Exhibit 1610-10](#), Case 1).
- On projects where no roadway widening is proposed and site constraints prevent providing the 2-foot shoulder widening behind the barrier, long post installations are available as shown in [Exhibit 1610-10](#), Cases 3, 4, 5, and 6. When installing guardrail where the roadway is to be widened or along new alignments, the use of Cases 5 and 6 requires a Design Analysis.

Exhibit 1610-9 Beam Guardrail Installation on 6:1 to 10:1 Slopes

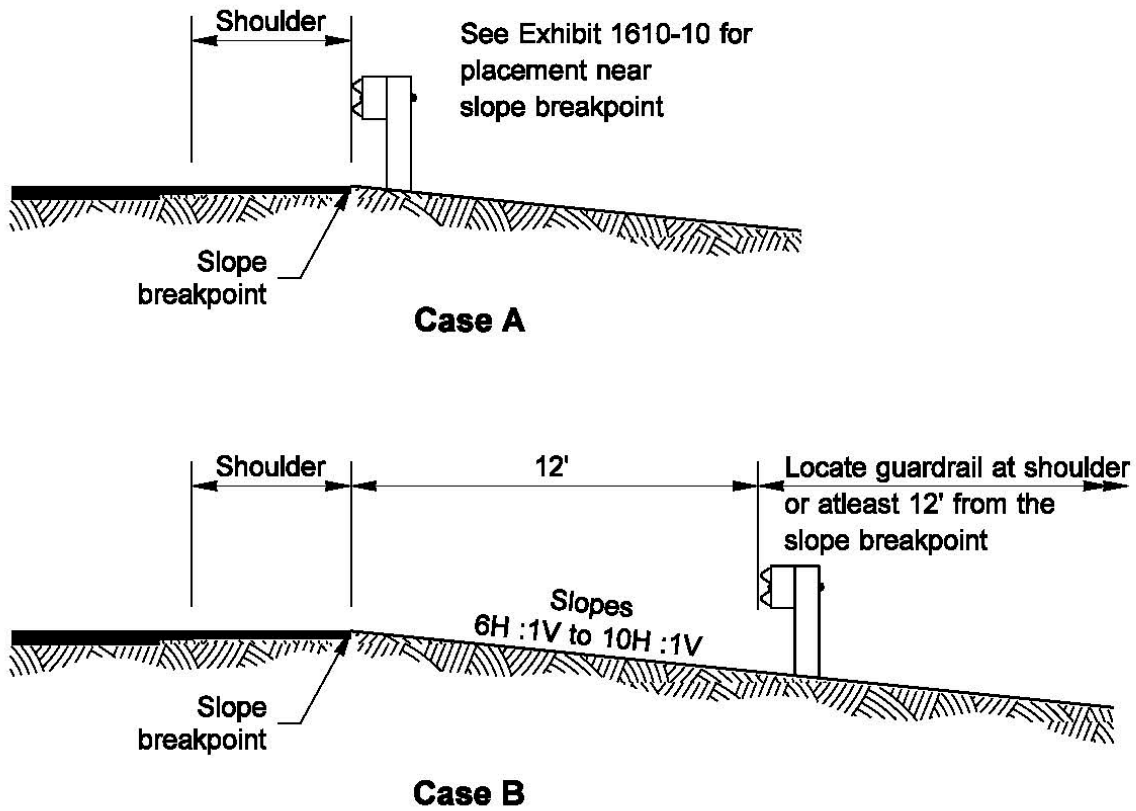
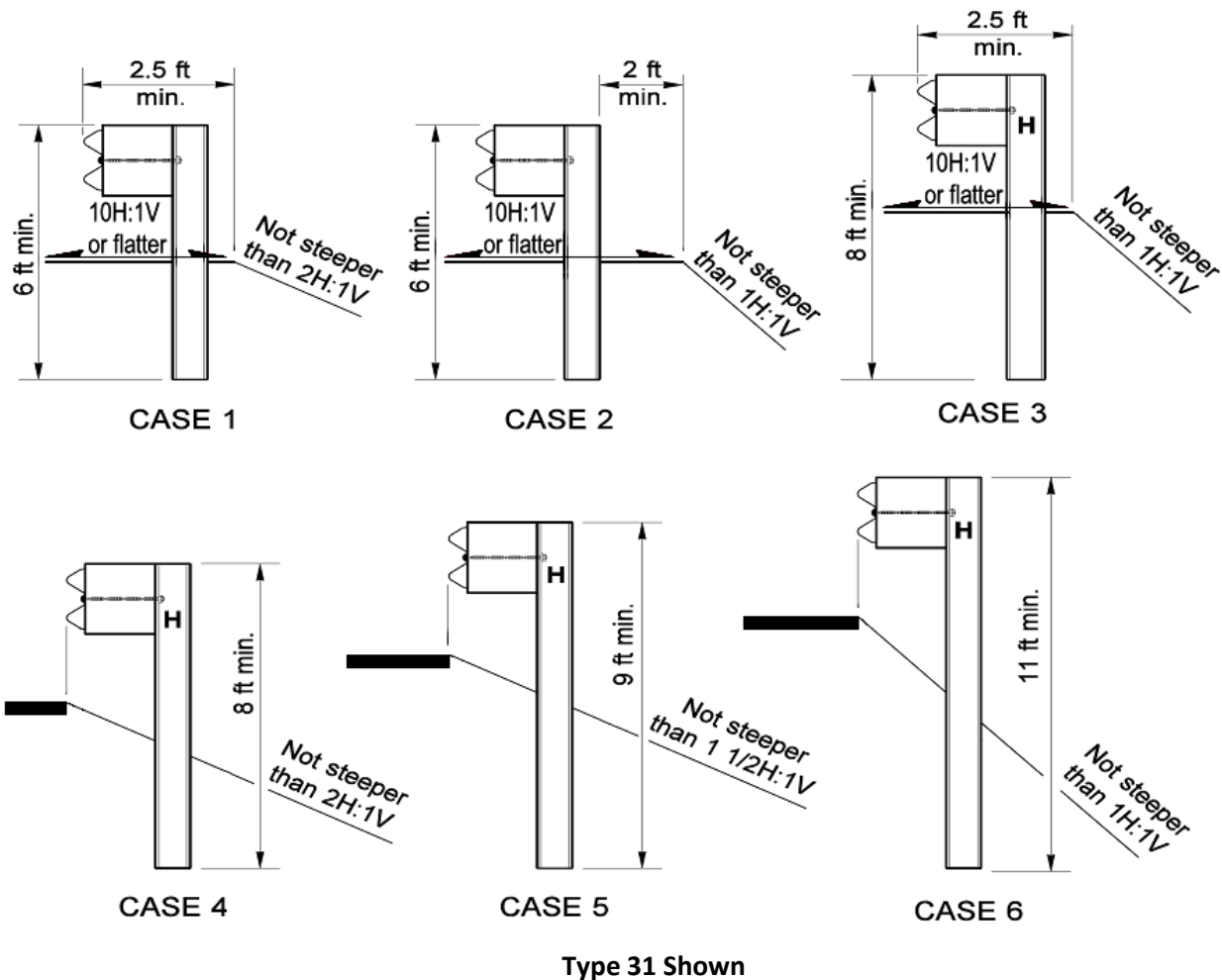

Exhibit 1610-10 Beam Guardrail Post Installation

**Notes:**

- Use Cases 1 and 3 when there is a 2.5-foot or greater shoulder widening from face of guardrail to the slope breakpoint.
- Use Case 2 when there is a 4.0-foot or greater shoulder widening from the face of the guardrail to the slope breakpoint.
- Use Cases 4, 5, and 6 when there is less than a 2.5-foot shoulder widening from face of guardrail to the slope breakpoint.
- Cases shown do not apply to terminals, transition sections or anchors. Install terminals, transition sections and anchors per the [Standard Plans](#).

1610.04(3) W-Beam Barrier Height

For Pavement Preservation (P1) projects see [Chapter 1120](#).

For other projects with existing Type 1 guardrail runs under 26.5 inches, adjust or replace the rail to a height of 28 inches minimum to 30 inches maximum, or replace the run with the 31-inch-high Type 31 beam guardrail.

If Type 1 Alternative W-beam guardrail is present, the rail element may be raised after each overlay. If Type 1 Alternative is not present, the blockout and rail element may be raised up to 4 inches. This requires field drilling a new hole in the guardrail post. See the [Standard Plans](#).

1610.04(4) Additional Guidance

Additional guidance related to w-beam guardrail:

- Locations where crossroads and driveways cause gaps in the guardrail create situations requiring special consideration. Elimination of the need for the barrier is the preferred solution. At these locations, a barrier flare might be needed to provide sight distance.
- Rail washers on beam guardrail are not normally used. If rail washers are present, removal is not necessary. However, if the rail element is removed for any reason, do not reinstall rail washers. In areas where heavy snow accumulations are expected to cause the bolts to pull out, specify snowload post washers and rail washers in the contract documents (snowload post washers are used to help prevent the bolts from pulling through the posts, and snowload rail washers are used to help prevent the bolt head from pulling through the rail). In other installations, it is normal to have the rail pull loose from the bolt head when impacted. Do not use rail washers within the limits of a guardrail terminal except, for some models, at the end post when they are needed for anchorage of the rail.
- The use of curb in conjunction with beam guardrail is discouraged. If a curb is needed, the 3 inch-high curb is preferred. If necessary, the 4-inch-high extruded curb can be used behind the face of rail for any posted speed. The 6-inch-high extruded curb can be used at locations where the posted speed is 50 mph or below. When replacing extruded curb at locations where the posted speed is above 50 mph, use 3 inch-high or 4-inch-high curb. (See the [Standard Plans](#) for extruded curb designs.)
- When curb is used in conjunction with Type 31 W-beam guardrail, an acceptable option is to place up to a 6-inch-high extruded curb at a maximum 6 inch offset in front of the face of the rail at any posted speed. Contact the WSDOT Design Office for more information.
- Guardrail posts are expected to be able to rotate when the rail is impacted. The installation of strong post W-beam guardrail posts in rigid surfacing such as asphalt or concrete pavement involves specially designed post holes that will allow the posts to rotate. Contact the WSDOT Design Office for more information.
- For (Old) Guardrail Types 1, 2, 3, and 4, it is acceptable to use blockouts that extend the rail element from the post for a distance not to exceed 16 inches.
- Where it is not feasible to install a post on a Type 31 system, one post may be omitted every 56.25 feet (9th post), except that an omitted post must be a minimum of 75 feet from an anchorage post, a minimum of 35 feet from the beginning of a thrie beam transition, and a minimum of 35 feet from the point where a terminal system joins the standard run.
 - Do not omit posts in guardrail runs with posts placed less than 2 feet from the slope break point, at the slope break point, or beyond the slope break point (down the slope). The guardrail posts must have at least 2 feet of 10:1 or flatter embankment behind them as shown in DM Exhibit 1610-10 Case 2.
 - Do not omit posts where curb is in front the guardrail.

- Consult HQ Design before omitting posts in guardrail runs that have long span systems (see Std. Plan C-20.40) placed within the run.

1610.04(5) Terminals and Anchors

A guardrail anchor is required at the end of a run of guardrail to develop tensile strength throughout its length. In addition, when the end of the guardrail is subject to head-on impacts, a crash-tested guardrail terminal is required (see the [Standard Plans](#)).

Replace guardrail terminals that do not have a crash-tested design with crash-tested guardrail terminals. Common features of systems that do not meet current crash-tested designs include:

- No cable anchor.
- A cable anchored into concrete in front of the first post.
- Second post not breakaway (CRT).
- Design A end section.
- Design C end sections may be left in place if the terminal is otherwise a crash-tested design —see the [Standard Plans](#) for end section details.
- Terminals with beam guardrail on both sides of the posts (two-sided).
- Buried guardrail terminals that slope down such that the guardrail height is reduced to less than 28 inches (measured in relation to a 10H:1V line extended from the breakpoint at edge of shoulder).

When the height of a terminal, as measured from the ground to the top of the rail element, will be affected by the project, adjust the terminal based upon the following criteria:

- If the height of the terminal adjoining Types 1, 2, 3, or 4 guardrail will be reduced by the project to be less than 26.5 inches or increased to greater than 30 inches, adjust the height of the terminal to a minimum of 28 inches and a maximum of 30 inches. A terminal height of 30 inches is desirable to accommodate future overlays.
- If the height of the terminal adjoining Type 31 guardrail will be reduced by the project to be less than 28 inches or increased to greater than 32 inches, adjust the height of the terminal to 31 inches.

When adjusting terminals that are equipped with CRT posts, the top-drilled holes in the posts need to remain at the surface of the ground.

One terminal that was used extensively on Washington's highways was the Breakaway Cable Terminal (BCT). This system used a parabolic flare similar to the Slotted Rail Terminal (SRT) and a Type 1 anchor (Type 1 anchor posts are wood set in a steel tube or a concrete foundation). For guidance regarding BCT's and other terminals on Preservation projects see [Chapter 1120](#). For non-Preservation projects, replace BCTs with a currently approved terminal using the following guidance:

Verify length of need, and adjust the terminal location as required. Replace adjacent transition sections that are not compliant with 1610.04(6). Transition from Type 1 to Type 31 using the adaptor (Standard Plan C-25.80) where required. Raise or replace the entire run if engineering judgement indicates that it is prudent for that situation. Use the grading criteria shown on the

terminal standard plans (C-22.40 or C-22.45). When using existing grading, check to see that it complies with the grading criteria shown on the current terminal standard plans. Remove curbs from in front of terminals if hydraulically acceptable.

Information regarding (Old) Type 1 beam guardrail terminals can be found at:

🔗 <http://www.wsdot.wa.gov/Design/Policy/RoadsideSafety.htm>

1610.04(5)(a) Buried Terminal (BT) for Type 31 Beam Guardrail

A buried terminal is designed to terminate the guardrail by burying the end in a backslope. The BT is the preferred terminal because it eliminates the exposed end of the guardrail.

For new BT installations, use the Buried Terminal Type 2. Previously, another BT option (the Buried Terminal Type 1) was an available choice. For existing installations, it is acceptable to leave this option in service as long as height requirements and other design criteria is met. See the plan sheet at: 🔗 www.wsdot.wa.gov/design/standards/plansheet.

The BT uses a Type 2 anchor to develop the tensile strength in the guardrail. The backslope needed to install a BT is to be 3H:1V or steeper and at least 4 feet in height above the roadway. The entire BT can be used within the length of need for backslopes of 1H:1V or steeper if the barrier remains at full height in relation to the roadway shoulder to the point where the barrier enters the backslope.

For backslopes between 1H:1V and 3H:1V, design the length of need beginning at the point where the W-beam remains at full height in relation to the roadway shoulder—usually beginning at the point where the barrier crosses the ditch line. If the backslope is flatter than 1H:1V, provide a minimum 20-foot-wide by 75-foot-long clear area that is free of fixed features behind the barrier and between the beginning length of need point at the terminal end to the mitigated object to be protected.

Flare the guardrail to the foreslope/backslope intersection using a flare rate that meets the criteria in [1610.03\(4\)](#). Provide a 4H:1V or flatter foreslope into the face of the guardrail and maintain the full guardrail height to the foreslope/backslope intersection in relation to a 10H:1V line extending from edge of shoulder breakpoint. (See the [Standard Plans](#) for details.)

1610.04(5)(b) Non-flared Terminals for Type 31 Beam Guardrail

If a buried terminal cannot be installed as described in [1610.04\(5\)\(a\)](#), install a non-flared terminal. These systems use W-beam guardrail with a special end piece that fits over the end of the guardrail. When hit head on, the end piece is pushed over the rail, absorbing the energy of the impacting vehicle in the process. An anchor is included for developing the tensile strength of the guardrail. The length of need does not begin at the impact head, but will vary by system. Non-flared terminals may be provided for two different design levels that are based on the posted speed of the highway. For highways with a posted speed of 50 mph or above, use only a TL-3 (Test Level 3) product. For highways with a posted speed of 45 mph or below, either a TL-2 or a TL-3 product is acceptable. See the [Standard Plans](#).

The availability and acceptance of these systems is expected to change rapidly over time. Refer to the Type 31 Beam Guardrail Terminals website for the latest information on availability or acceptance of different systems (see

🔗 <http://www.wsdot.wa.gov/Design/Policy/RoadsideSafety.htm>).

Although non-flared terminals do not need to have an offset at the end, a flare is recommended so that the end piece does not protrude into the shoulder. See the [Standard Plans](#).

Four feet of additional widening behind the terminal is needed at the end posts to properly anchor the systems (See the [Standard Plans](#)). When widening includes an embankment, properly placed and compacted fill material will be necessary for optimum terminal performance (see the [Standard Specifications](#) for embankment widening for guardrail).

For guardrail runs that are located more than 12 feet from the slope break (as shown in [Exhibit 1610-9](#)) no additional embankment widening is required at the terminal.

No snowload rail washers are allowed within the limits of these terminals.

WSDOT does not currently use a flared terminal system for the Type 31 guardrail system.

Note: Approved shop drawings for terminals can be found by accessing the following website:

🔗 <http://www.wsdot.wa.gov/Design/Policy/RoadsideSafety.htm>

1610.04(5)(c) Terminal Evolution Considerations

Some currently approved terminals have been in service for a number of years. During this time, there have been minor design changes. However, these minor changes have not changed the devices' approval status. Previous designs for these terminals may remain in place.

Note: If questions arise concerning the current approval status of a device, contact the HQ Design Office for clarification when replacement is being considered.

1610.04(5)(d) Anchors

A guardrail anchor is needed at the end of a run of guardrail to develop tensile strength throughout its length.

- Use the Type 10 anchor to develop the tensile strength of the guardrail on the end of Type 31 guardrail runs where a crash-tested terminal is not needed.
- A Type 2 anchor is used with the buried terminal.

For information on anchor types used in runs of (Old) Beam Guardrail Type 1, see:

🔗 <http://www.wsdot.wa.gov/Design/Policy/RoadsideSafety.htm>.

1610.04(6) Transitions and Connections

When there is an abrupt change from one barrier type to a more rigid barrier type, a vehicle hitting the more flexible barrier may be caught in the deflected barrier pocket and directed into the more rigid barrier. This is commonly referred to as "pocketing." A transition stiffens the more flexible barrier by decreasing the post spacing, increasing the post size, and using stiffer beam elements to reduce the possibility of pocketing.

When connecting beam guardrail to a more rigid barrier or a structure use the transitions and connections that are shown in [Exhibits 1610-12](#) and [1610-13](#) and detailed in the [Standard Plans](#). Verify the length of need (see [1610.03\(5\)](#)) when designing transitions, particularly transitions between beam guardrail or end terminals to bridge structures.

Type 21 transitions can be used on highways with all posted speeds to connect w-beam guardrail to single slope, safety shape or vertical concrete barriers.

Type 22 and Type 23 transitions are used to connect w-beam guardrail to thrie beam on bridges.

Type 24 transitions can be used on highways with a posted speed of 45 mph or less to connect w-beam guardrail to single slope, safety shape or vertical concrete barriers.

When connecting a Type 21 or Type 24 Transition to an existing vertical faced bridge rail with a low parapet, a special connection plate may be required. Coordinate with the WSDOT Bridge and Structures Office (BSO). The transition pay item includes the connection.

For information regarding transitions used with (Old) Type 1 guardrail see:
<http://www.wsdot.wa.gov/Design/Policy/RoadsideSafety.htm>.

Exhibit 1610-12 Guardrail Connections

Condition	Connection
Unrestrained concrete barrier	A
Rigid, rigid anchored, untapered safety shape bridge rails or barriers [1]	B
Bridge rails with curbs 9 inches or less in width	B
Bridge rails with curbs between 9 and 18 inches wide	C
Vertical walls, single slope, or tapered safety shape barrier [1]	D
<p>Note: [1] New single slope and safety shape bridge rails are designed with the toe of the barrier tapered so that it does not project past the face of the approach guardrail.</p>	

Exhibit 1610-13 Transitions and Connections

Connecting Type 31 W-Beam Guardrail to:		Transition Type*	Connection	
Bridge Rail ^[1]	New Installation	21, 24 ^[3]	D	
	Existing Concrete	Concrete Parapet > (Greater Than) 20 in.	21, 24 ^[3]	Exh. 1610-12 ^[2]
		Concrete Parapet < (Less Than) 20 in.	21, 24 ^[3]	Exh. 1610-12 ^[2]
	Thrie Beam at Face of Curb	Approach End	23	n/a
		Trailing End (two-way traffic only)	23	n/a
	Thrie Beam at Bridge Rail (curb exposed)	Approach End	22	n/a
Trailing End (two-way traffic only)		22	n/a	
Concrete Barrier	Rigid & Rigid Anchored	21, 24 ^[3]	Exhibit 1610-12	
	Unrestrained	21, 24 ^[3]	A	
Rigid Structures such as Bridge Piers	See Placement Cases 11A-31 through 11C-31	21, 24 ^[3]	n/a	
Connecting Thrie Beam Guardrail to:		Transition Type*	Connection	
Bridge Rail or Concrete Barrier	See the thrie beam transition in the Plan Sheet Library		Exhibit 1610-12	

*Consult Section C of the [Standard Plans](#) for details on transition types.

Notes:

- [1] For Service Level 1 bridge rail, see: <http://www.wsdot.wa.gov/Design/Policy/RoadsideSafety.htm>., Type 1 Beam Guardrail Placement Cases, Placement Case 14.
- [2] When connecting a Type 21 or Type 24 Transition to an existing vertical faced bridge rail with a low parapet, a special connection plate may be required. Contact the WSDOT BSO for details.
- [3] Transition Type 21 is acceptable for use on highways with all posted speeds. Transition Type 24 is acceptable for use on highways with posted speeds 45 mph or below.

1610.04(7) Guardrail Placement Cases

The [Standard Plans](#) and [Plan Sheet Library](#) contain placement cases that show beam guardrail elements needed for typical situations. For new installations, use the appropriate Type 31 placement option (except as noted below).

Information regarding placement cases for (Old) Type 1 beam guardrail can be found at <http://www.wsdot.wa.gov/Design/Policy/RoadsideSafety.htm>.

1610.04(7)(a) Beam Guardrail Placements

- Case 1-31 is used where there is one-way traffic. It uses a crash-tested terminal on the approach end and a Type 10 anchor on the trailing end.
- Case 2-31 is used where there is two-way traffic. A crash-tested terminal is used on both ends.
- Case 3-31 is used at railroad signal supports on one-way or two-way roadways. A terminal is used on the approach end, but usually cannot be used on the trailing end because of its proximity to the railroad tracks. If there is a history of crossover collisions, consider additional protection such as an impact attenuator.
- Case 4-31 is used where guardrail on the approach to a bridge is to be shifted laterally to connect with the bridge rail. A terminal is used on the approach end and a transition is needed at the bridge end. Curves (bends) are shown in the guardrail to shift it to the bridge rail. However, the length of the curves are not critical. The criterion is to provide smooth curves that are not more abrupt than the allowable flare rate (see Exhibit 1610-4).
- Case 5-31 is a typical bridge approach where a terminal and a transition are needed.
- Case 10 (A-31, B-31, and C-31) is used at roadside fixed features (such as bridge piers) when 5 or more feet are available from the face of the guardrail to the feature. The approach end is the same for one-way or two-way traffic. Case 10A-31 is used with two-way traffic; therefore, a terminal is needed on the trailing end. Case 10B-31 is used for one-way traffic when there is no need to extend guardrail past the bridge pier and a Type 10 anchor is used to end the guardrail. Case 10C-31 is used for one-way traffic when the guardrail will extend for a distance past the bridge pier.
- Case 11 (A-31, B-31, and C-31) is used at roadside fixed features (such as bridge piers) when the face of guardrail is to be placed within 5 feet of the feature. Since there is no room for deflection, the rail in front of the feature is to be considered a rigid system and a transition is needed. The trailing end cases are the same as described for Case 10.
- Beam Guardrail Type 31 (12'6", 18'9", or 25' Span) is used when it is necessary to omit one, two, or three posts. This application is typically used when guardrail is installed over a shallow buried obstruction, such as drainage structures. This design may be used in other situations where there are no above ground objects located behind the guardrail and within the lateral deflection distance. Three CRT posts are provided on each end of the omitted post(s).
- Guardrail Placement at intersections – Two solutions are currently available for use where bridge ends or similar conditions exist in close proximity to a roadway intersection or driveway. These designs are used at crossroads or road approaches

where a barrier is needed and where the length of need cannot be achieved using standard components such as standard longitudinal barrier runs, transitions, and terminals. The “Strong Post Intersection Design” uses Type 31 guardrail and is available for use in new installations. A “Weak Post Intersection Design,” which uses Type 1 guardrail, is available and may also be used in new installations (see 1610.04(1)(b)).

1610.05 High-Tension Cable Barrier

Cable barrier is a flexible barrier system that can be used on a roadside or as a median barrier. Early cable barrier designs centered around low-tension cable systems. With research and crash analysis of these systems, the designs evolved into high-tension cable systems. These high-tension cable systems are primarily used in medians and are preferred for many installations due in part to high benefit-to-cost ratios. Read about advantages for selecting a cable barrier system here:

🔗 <http://www.wsdot.wa.gov/publications/fulltext/design/Policy/CableBarriers.pdf>.

There are a number of manufacturers of high-tension cable barrier systems. These systems have been designed using either three or four-cables fixed to metal posts placed at a fixed spacing. Each cable system has specially designed anchors placed at both ends of the barrier run to provide the proper tensioning in the cables. Currently, both three and four-cable high-tension cable barrier systems are installed along WSDOT state routes. See additional information about these approved cable barrier systems here:

🔗 <http://www.wsdot.wa.gov/publications/fulltext/design/Policy/CableBarriers.pdf>.

Use four-cable high-tension cable barrier systems for all new installations.

1610.05(1) High-Tension Cable Barrier Placement

High-tension cable barrier can be placed in a median or along the roadside.

Note: Additional placement cases are shown in the WSDOT *Standard Plans*. For non-typical installations, such as double runs of cable barrier or median ditch cross sections that differ significantly from those shown, contact the HQ Design Office for guidance.

1610.05(1)(a) Median Applications

For typical cable barrier installations in a median, the following apply (see [Exhibit 1610-14a](#)):

- Install the cable barrier as far from the edge of traveled way as site constraints allow. Consider a minimum placement distance of 8 feet from the edge of traveled way to allow vehicles to use this area for refuge.
- Install cable barrier on slopes 6H:1V or flatter.
- There are approved high-tension cable barrier systems that can be placed on slopes as steep as 4H:1V. The use of these systems requires special placement considerations, contact the HQ Design Office for guidance.
- Provide an obstruction free zone within the cable barrier system’s lateral deflection distance (see [1610.05\(2\)](#)).
- On tangent sections of a roadway where no ditch is present, consider installing the cable barrier in the middle of the median.

- Along horizontal curves, consider installing the cable barrier along the inside of the curve. Reduce the post spacing per manufacturer's recommendations.
- Where a ditch is present, install cable barrier at the centerline of the ditch or within 1-foot of the ditch centerline.
- Avoid installing cable barrier within the range between 1-foot to 8-foot offset from the ditch centerline to avoid "under-riding" of vehicles that cross the ditch (see [Exhibit 1610-14a](#)).
- In some situations, it may be advantageous to terminate a run of cable barrier on one side of the median (to provide maintenance access to a feature, for example) and then begin an adjacent cable barrier run on the opposite side of the median. In this application, it is important to provide adequate cable barrier overlap distance between the two runs. For placement guidance, see [Exhibit 1610-15](#).
- Narrow medians provide little space for maintenance crews to repair or reposition the barrier. Wherever site conditions permit, provide at least 14 feet of clearance from the adjacent lane edge to the face of the cable barrier.

Exhibit 1610-14a Median Cable Barrier Placement

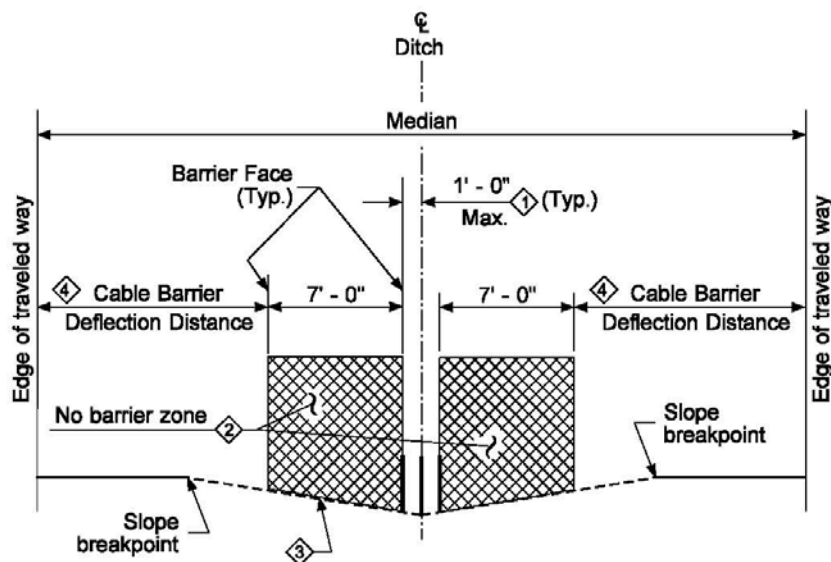

Cable Barrier Placement in Median with Ditch

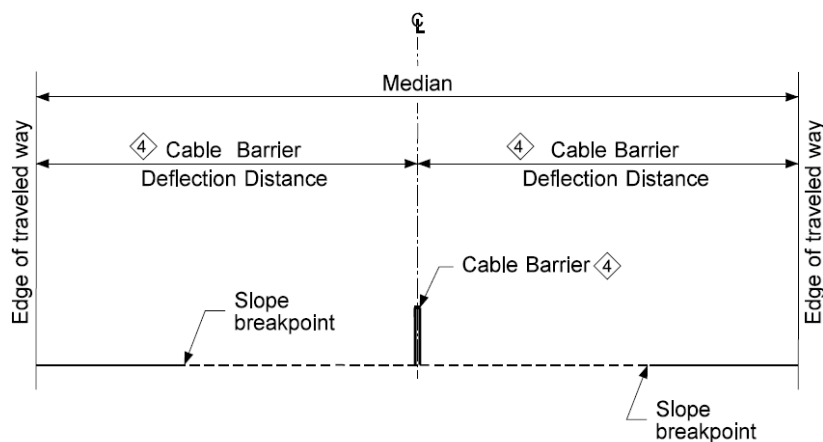

Cable Barrier Placement in Median with No Ditch

Notes:

- ① Cable barrier may be installed in the center of the ditch and from the ditch centerline a maximum of 1 foot (left or right).
- ② Avoid installing cable barrier within a range of 1-foot to 8-foot offset from the ditch centerline.
- ③ Applies to slopes 6H:1V or flatter.
- ④ Provide an obstruction free zone within the cable barrier's lateral deflection distance, see 1610.05(2)

1610.05(1)(b) Roadside Applications

For typical non-median roadside applications, the following apply (see Exhibit 1610-14b):

- Install the cable barrier as far from the edge of traveled way as site constraints allow.
- Consider a minimum placement distance of 8 feet from the edge of traveled way to allow vehicles to use this area for refuge.
- Install cable barrier on slopes 6H:1V or flatter
- There are approved high-tension cable barrier systems that can be placed on slopes as steep as 4H:1V. The use of these systems requires special placement considerations, contact the HQ Design Office for guidance.
- Along horizontal curves, consider installing along the inside of the curve. Reduce post spacing per manufacturer's recommendations
- Provide an obstruction free zone within the cable barrier system's lateral deflection distance, see 1610.05(2).

Exhibit 1610-14b Roadside Cable Barrier Placement

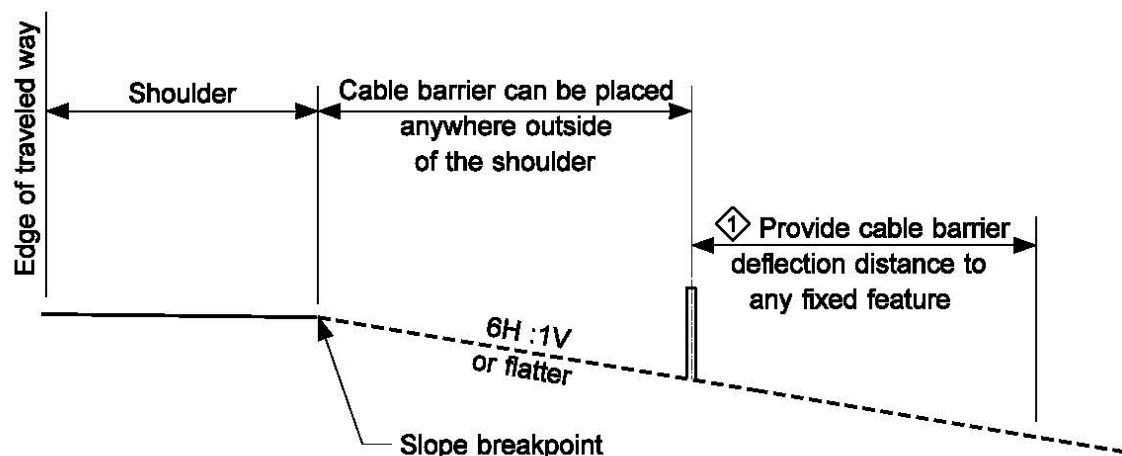

Notes:

- 1 Provide an obstruction free zone within the cable barrier's lateral deflection distance, see 1610.05(2)

1610.05(2) High-Tension Cable Barrier Lateral Deflection Distances

Depending on the high-tension cable barrier system, lateral deflection distances for each barrier system vary based upon the length of the barrier run, the spacing of the end anchors, and post spacing. Provide an obstruction free zone within the system's lateral deflection distance for the following situations:

1. In the direction of travel (located in the median or along roadside), locate the cable barrier system so that there are no fixed objects within the limits of the cable barrier lateral deflection distance.

2. For opposing traffic (where present), locate the cable barrier to provide lateral deflection distance to prevent a vehicle's encroachment into the opposite lane of travel.

Low-tension cable barrier systems require 12 feet of lateral deflection. Use high-tension cable barrier systems in new cable barrier installations. High-tension barrier systems have lateral deflection distances between 6 to 10 feet. Specify the minimum allowable lateral deflection distance in the contract documents in order for the contractor to select a cable barrier manufacturer that meets the lateral deflection requirements.

Note: There are new high-tension cable barrier systems under development that may change selection and placement criteria. For example, newer systems may allow placement on steeper slopes or have reduced deflection distances. Contact the HQ Design Office for guidance.

1610.05(3) High-Tension Cable Barrier Height

A high-tension four-cable barrier system shall provide a height to the center of the top cable of not less than 35 inches and a height to the center of the bottom cable not greater than 19 inches. Previous testing of cable barrier systems has shown that providing cables within the ranges specified typically restrains a vehicle traversing the various slopes and reduces the possibility of the vehicle either overriding or under riding the cable barrier.

1610.05(4) High-Tension Cable Barrier Termination

Manufacturers of high-tension four-cable barrier systems provide designed anchors for the ends of cable barrier runs. Other alternatives to end a cable barrier include:

- It is possible to terminate high-tension cable barrier systems by connecting directly to beam guardrail runs (such as transitions to bridge rails) or to a separate cable barrier anchorage system. Review field conditions, check local maintenance personnel needs, and then specify the required connection option in the contract documents. If a separate anchorage system is used, refer to [Exhibit 1610-15](#) for placement guidance.
- When cable barrier is connected to a more rigid barrier, a transition section is typically needed. Contact the HQ Design Office for further details.

Exhibit 1610-15 Cable Barrier Placement for Divided Highways

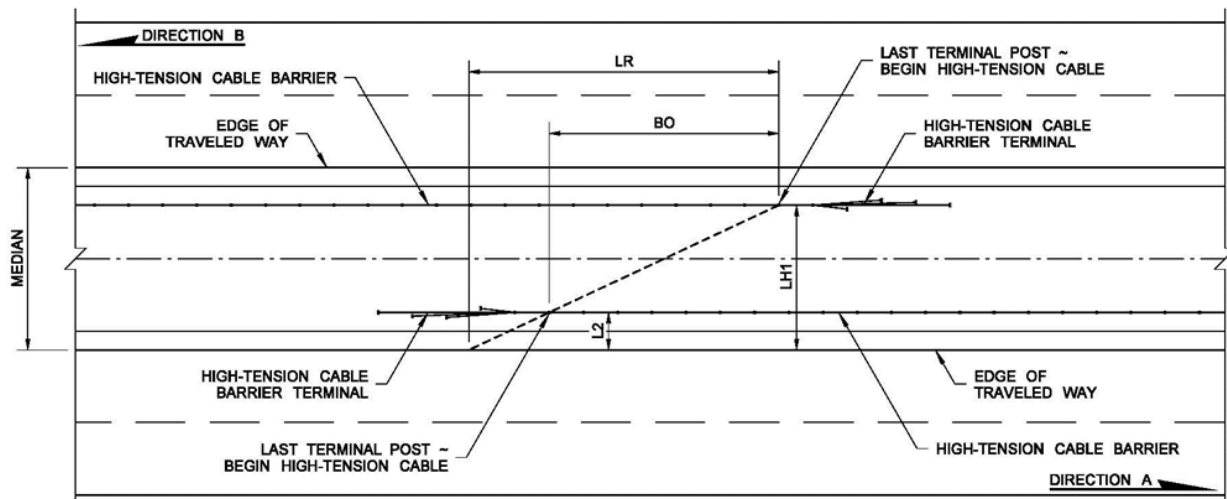

Cable Barrier Median Overlap

$$BO = \frac{LH1 - L2}{(LH1/LR)} \quad (\text{Direction A shown})$$

Note:

Calculate barrier overlap (BO) from both directions of travel. Use the greatest value of BO obtained.

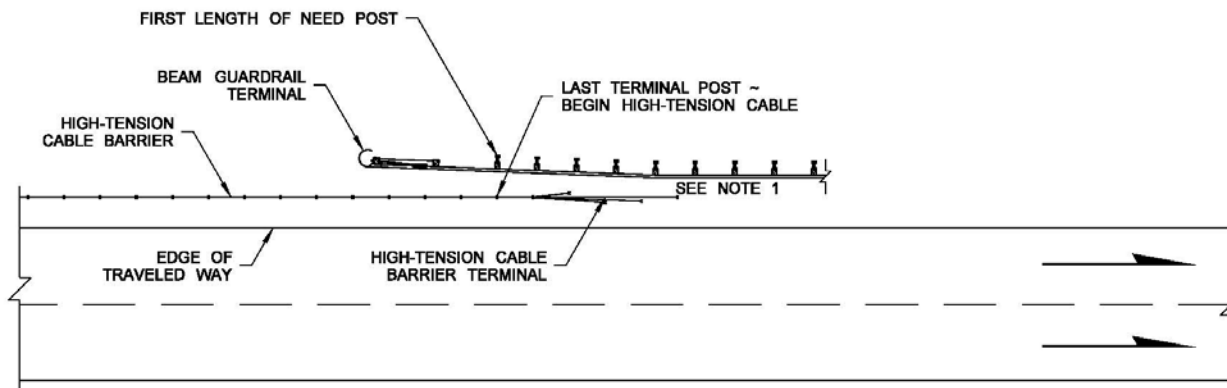

Cable Barrier Overlap with Beam Guardrails

Notes:

- The beam guardrail may need to be extended and flared to maintain adequate barrier overlap and shoulder width.
- Typical applications may be at either bridge transitions or where high-tension cable and beam guardrail systems end or begin.
- For supporting length of need equation factors, see [Exhibit 1610-6](#).

1610.05(5) High-Tension Cable Barrier Curb Placement

Avoid the placement of curb in conjunction with high-tension cable barrier systems. Currently, there are no known acceptable cable barrier systems that have been successfully crash tested with this feature present.

1610.06 Concrete Barrier

Concrete barriers are identified as either rigid, rigid anchored, or unrestrained rigid systems. They are commonly used in medians and as shoulder barriers. These systems are stiffer than beam guardrail or cable barrier, and impacts with these barriers tend to be more severe. Consider the following when installing concrete barriers:

- For slopes 10H:1V or flatter, concrete barrier can be used anywhere outside of the shoulder.
- Do not use concrete barrier at locations where the foreslope into the face of the barrier is steeper than 10H:1V.
- Light standards mounted on top of precast concrete median barrier must not have breakaway features. (See the concrete barrier light standard section in the [Standard Plans](#).)
- When considering concrete barrier use in areas where drainage and environmental issues (such as stormwater, wildlife, or endangered species) might be adversely impacted, contact the HQ Hydraulics Office and/or the appropriate environmental offices for guidance. Also, refer to [1610.02](#).

1610.06(1) Concrete Barrier Shapes

Concrete barriers use a single-slope or safety shape (New Jersey or F-Shape) to redirect vehicles while minimizing vehicle vaulting, rolling, and snagging. A comparison of these barrier shapes is shown in Exhibit 1610-16.

The single-slope barrier face is the recommended option for embedded rigid concrete barrier applications.

Exhibit 1610-16 Concrete Barrier Shapes

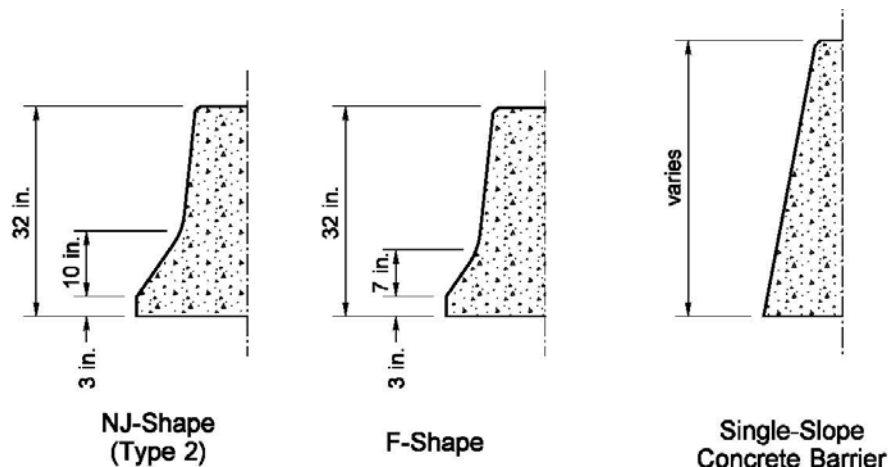

When the single-slope or F-Shape face is used on structures, and precast barrier is selected for use on the approaches, a cast-in-place transition section is needed so that no vertical edges of the barrier are exposed to oncoming traffic. For details on bridge rail designs, see the [Bridge Design Manual](#).

For aesthetic reasons, avoid changes in the shape of the barrier face within a project or corridor.

The New Jersey shape and F-shape barriers are commonly referred to as “safety shapes.” The New Jersey shape and F-shape have an initial overall height of 32 inches. This height includes provision for up to a 3-inch future pavement overlay that can reduce the barrier height to 29 inches minimum.

As part of the implementation of MASH-compliant hardware WSDOT is transitioning from predominantly using New Jersey shape barrier (Type 2 barrier) for precast concrete barrier to using F-shape concrete barrier (Type F barrier) instead. For permanent installations of non-embedded precast concrete barrier F-shape (Type F) barrier is preferred. New Jersey shape (Type 2) barrier is still allowed.

For projects requiring variations of Type F barrier with no Standard Plan yet available, using Type 2 barrier instead is appropriate, or contact the HQ Design Office for more information.

To learn more about WSDOT’s plan for implementing MASH-compliant hardware see the following website: <http://www.wsdot.wa.gov/Design/Policy/RoadsideSafety.htm>

1610.06(1)(a) Safety Shape Barrier

Concrete Barrier Type F (see the [Standard Plans](#)) is a freestanding precast barrier that has the F-shape on both sides. It can be used for both median and shoulder installations. Unanchored units are connected with steel pins through metal loops. For permanent installation, this barrier is placed on a paved surface and a paved surface is provided beyond the barrier for deflection. See [Exhibit 1610-3](#) for deflection requirements.

The New Jersey shape face is primarily used on precast concrete barrier. Concrete Barrier Type 2 (see the [Standard Plans](#)) is a freestanding precast barrier that has the New Jersey shape on two sides. It can be used for both median and shoulder installations. Unanchored units are connected with steel pins through wire rope loops. For permanent installation, this barrier is placed on a paved surface and a paved surface is provided beyond the back of barrier for deflection. See [Exhibit 1610-3](#) for deflection requirements.

The cost of precast safety shape barrier is significantly less than the cost of the cast-in-place barriers. Therefore, consider the length of the barrier run and the deflection needs to determine whether transitioning to precast barrier is desirable. If precast safety shape barrier is used for the majority of a project, use the safety shape for small sections that need cast-in-place barrier, such as for a light standard section, see the [Standard Plans](#) for additional details for transitioning the barrier faces.

Concrete barrier Type 4 is a precast, single-faced New Jersey shape barrier. These units are not freestanding and are to be placed against a rigid structure or anchored to the pavement. If Type 4 barriers are used back to back, fill any gap between them to prevent tipping.

Precast barrier can be anchored where a more rigid barrier is needed. (Anchoring methods are shown in the [Standard Plans](#).) Anchors Type 1 and Type 2 are for temporary installations on a rigid pavement. Type 3 anchors can be used in temporary or permanent installations on an

asphalt pavement. Consult the WSDOT BSO for details when anchoring permanent precast concrete barrier to a rigid (Portland cement concrete) pavement.

Precast barrier used on the approach to bridge rail is to be connected to the bridge rail by installing loops embedded into the bridge rail with epoxy resin and as detailed in the [Standard Plans](#).

Place unrestrained (unanchored) precast concrete barrier on slopes of 5% (20H:1V) or flatter where possible. The maximum slope for placement of concrete barrier is 10% (10H:1V).

In the past WSDOT used a Type 5 single-faced New Jersey shape for special applications, such as adjacent to bridge rails with similar shapes. The Type 5 barrier is seldom used by WSDOT. See the Plan Sheet Library for more information on Type 5 barrier:

<http://www.wsdot.wa.gov/Design/Standards/PlanSheet/TB-5.htm>.

1610.06(1)(b) Single-Slope Barrier

Single-slope barrier is available in various heights, as shown in the [Standard Plans](#). Single-slope concrete barrier can be cast in place or precast. A primary benefit of using precast single-slope barrier is that it can be used as temporary barrier during construction and then reset into a permanent location. In temporary applications, the height of the single-slope barrier may also offer the added benefits of reducing headlight glare and providing reduced deflection characteristics over some other barrier types.

Single-slope barrier is considered a rigid system regardless of the construction method used provided the barrier is embedded a minimum of 3-inches in the roadway wearing surface on both sides. When precast single-slope barrier is installed on top of the roadway surface, it is considered a rigid unrestrained system and barrier deflection needs to be provided as shown in [Exhibit 1610-3](#).

For new installations, the minimum height of single-slope barrier above the roadway is 2 feet 10 inches, which allows a 2-inch tolerance for future overlays. The minimum total height of the barrier section is 3 feet 6 inches (including embedment). This allows for use of the 3-foot-6-inch barrier between roadways with grade separations of up to 5 inches. A grade separation of up to 10 inches is allowed when using a 4-foot-6-inch high barrier section, as shown in the [Standard Plans](#). The barrier is to have a depth of embedment equal to or greater than the grade separation. Contact the WSDOT BSO for grade separations greater than 10 inches.

1610.06(1)(c) High-Performance Concrete Barrier

High-Performance Concrete Barrier (HP Barrier) is a rigid barrier with a minimum height of 3-foot-6-inch above the roadway surface. This barrier is designed to function more effectively during heavy-vehicle crashes. This taller barrier may also offer the added benefits of reducing headlight glare and reducing noise in surrounding environments. WSDOT HP Barrier utilizes the single-slope shape. (See the [Standard Plans](#) for barrier details.)

Use HP Barrier in freeway medians of 22 feet or less. Also, use HP Barrier on Interstate or freeway routes where crash history suggests a need or where roadway geometrics increase the possibility of larger trucks hitting the barrier at a high angle (for example, on-ramps for freeway-to-freeway connections with sharp curvature in the alignment).

Consider the use of HP Barrier at other locations such as highways with narrow medians, near highly sensitive environmental areas, near densely populated areas, over or near mass transit facilities, or on vertically divided highways.

1610.06(1)(d) Low-Profile Barrier

Low-profile barrier designs are available for median applications where the posted speed is 45 mph or below. These barriers are normally used in urban areas. They are typically 18 to 20 inches high and offer sight distance benefits. For barrier designs, terminals, and further details, contact the HQ Design Office.

1610.06(2) Concrete Barrier Height

Overlays in front of safety shape concrete barriers can extend to the top of the lower, near-vertical face of the barrier before adjustment is necessary.

- Allow no less than 2-foot 5 inches from the pavement to the top of the safety shape barriers. Allow no less than 2-foot 8-inches from the pavement to the top of the single-slope barrier.

1610.06(3) Concrete Barrier Terminals

Whenever possible, bury the blunt end of a concrete barrier run into the backslope of the roadway. If the end of a concrete barrier run cannot be buried in a backslope or terminated as described below, terminate the barrier using a guardrail terminal and transition or an impact attenuator (see [Chapter 1620](#)).

To bury the blunt end of the barrier into a backslope, the following conditions must be met:

- The backslope is 3H:1V or steeper
- The backslope extends minimum of 4 feet in height above the edge of shoulder
- Flare the concrete barrier into the backslope using a flare rate that meets the criteria in 1610.03(4)
- Provide a 10H:1V or flatter foreslope into the face of the barrier and maintain the full barrier height until the barrier intersects with the backslope. This might create the need to fill ditches and install culverts in front of the barrier face.

The 7-foot-long precast concrete barrier Type 2 and the 10- to 12-foot single-slope barrier terminal (precast or cast-in-place) may be used for the following conditions:

- Outside the Design Clear Zone.
- On the trailing end of the barrier when it is outside the Design Clear Zone for opposing traffic.
- On the trailing end of one-way traffic.
- Where the posted speed is 25 mph or below.

See the [Standard Plans](#) for barrier terminal details.

1610.07 Bridge Traffic Barriers

Bridge traffic barriers redirect errant vehicles and help to keep them from going over the side of the structure. (See the [Bridge Design Manual](#) for information regarding bridge barrier on new bridges and replacement bridge barrier on existing bridges).

When considering work on a bridge traffic barrier consult the WSDOT Bridge and Structures Office (BSO).

- The standard bridge traffic barrier is a 3 foot 6 inch single slope or F Shape traffic barrier.
- For corridor continuity, a 2 foot 10 inch single slope or 2 foot 8 inch F Shape traffic barrier may be used with a pedestrian railing attached to the top for a total height of 3 foot 6 inch height inches. This also meets requirements for worker fall protection.

Approach barriers, transitions, and connections are usually needed on all four corners of bridges carrying two-way traffic and on both corners of the approach end for one-way traffic. (See 1610.04(6) for guidance on transitions). A transition is available to connect the Type 2 concrete barrier (New Jersey shape) and the bridge barrier (F-Shape.) (See the [Standard Plans](#) for further details).

Bridge railing attaches to the top of the bridge barrier. When bridge barrier is included in a project, the bridge rails, including crossroad bridge rail, are to be addressed. Consult the WSDOT BSO regarding bridge rail selection and design and for design of the connection to an existing bridge. Consider the following:

- Use an approved, NCHRP 350 or MASH crash-tested bridge traffic barrier on new bridges or bridges to be widened. The [Bridge Design Manual](#) provides examples of typical bridge rails. The BSO's minimum crash test level for all state and interstate bridges is a TL-4.
- An existing bridge rail on a roadway with a posted speed of 30 mph or below may remain in place if it is not located on a bridge over a National Highway System (NHS) highway. When Type 7 bridge rail is present on a bridge over an NHS highway with a posted speed of 30 mph or below, it may remain in place regardless of the type of metal rail installed. Other bridge rails are to be evaluated for strength and geometrics. (See [1610.07\(1\)](#) for guidance on retrofit techniques.)
- The Type 7 bridge rail is common. Type 7 bridge rails have a curb, a vertical-face parapet, and an aluminum top rail. The curb width and the type of aluminum top rail are factors in determining the adequacy of the Type 7 bridge rail, as shown in [Exhibit 1610-17](#). Consult the WSDOT BSO for assistance in evaluating other bridge rails.

When considering an overlay on a bridge, consult the WSDOT BSO to verify the overlay depth can be placed on the bridge deck based on the type of traffic barrier. There may be instances where the height of the bridge barrier will not allow for the planned overlay depth without removal of existing pavement.

Exhibit 1610-17 Type 7 Bridge Rail Upgrade Criteria

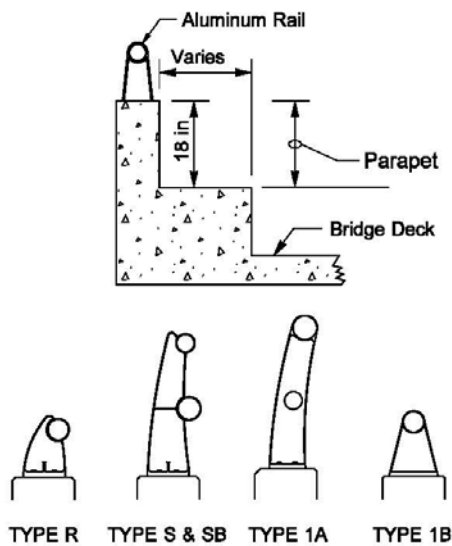

Aluminum Rail Type	Curb Width	
	9 Inches or Less	Greater Than 9 Inches*
Type R, S, or SB	Bridge rail adequate	Bridge rail adequate
Type 1B or 1A	Bridge rail adequate	Upgrade bridge rail
Other	Consult the WSDOT BSO	

*When the curb width is greater than 9 inches, the aluminum be able to withstand a 5 kip load.

1610.07(1) Bridge Barrier Retrofit

If the bridge barrier system does not meet the criteria for strength and geometrics, modifications to improve its redirectional characteristics and its strength may be needed. Consult the WSDOT BSO to determine which retrofit method described below can be completed.

1610.07(1)(a) Concrete Safety Shape

Consult the WSDOT BSO to determine whether the existing bridge deck and other superstructure elements are of sufficient strength to accommodate this bridge barrier system and provide design details for the retrofit. Retrofitting with a new concrete bridge barrier is costly and requires authorization from Program Management when no widening is proposed.

1610.07(1)(b) Thrie Beam Retrofit

Retrofitting the bridge barrier with thrie beam is an economical way to improve the strength and redirectional performance of a bridge barrier. The thrie beam can be mounted to steel posts or the existing bridge barrier, depending on the structural adequacy of the bridge deck, the existing bridge barrier type, the width of curb (if any), and the curb-to-curb roadway width carried across the structure. [Exhibit 1610-18](#) shows typical retrofit criteria.

Note that Bridges designated as historical landmarks may not be candidates for thrie beam retrofitting. Contact the Environmental Services Office regarding bridge historical landmark status.

Consider the Service Level 1 (SL-1) system on bridges with wooden decks and for bridges with concrete decks that do not have the needed strength to accommodate the thrie beam system. Contact the WSDOT BSO for information needed for the design of the SL-1 system.

If a thrie beam retrofit results in reduction in sidewalk width ensure ADA compliance is addressed, see Chapter 1510.

Exhibit 1610-18 Thrie Beam Rail Retrofit Criteria

Curb Width	Bridge Width	Concrete Bridge Deck		Wood Bridge Deck or Low-Strength Concrete Deck
		Concrete Bridge Rail (existing)	Steel or Wood Post Bridge Rail (existing)	
<18 inches		Thrie beam mounted to existing bridge rail ^[2] and blocked out to the face of curb. Height = 32 inches.	Thrie beam mounted to steel posts ^[2] at the face of curb. Height = 32 inches	<ul style="list-style-type: none"> • Service Level 1 Bridge Rail. ^[2] • Height = 32 inches. • Curb or wheel guard needs to be removed.
>18 inches	> 28 ft (curb to curb)	Thrie beam mounted to steel posts ^[2] at the face of curb. ^[1] Height = 32 inches.		
>18 inches	< 28 ft (curb to curb)	Thrie beam mounted to existing bridge rail. ^[2] Height = 35 inches.	Thrie beam mounted to steel posts ^[2] in line with existing rail. Height = 35 inches.	

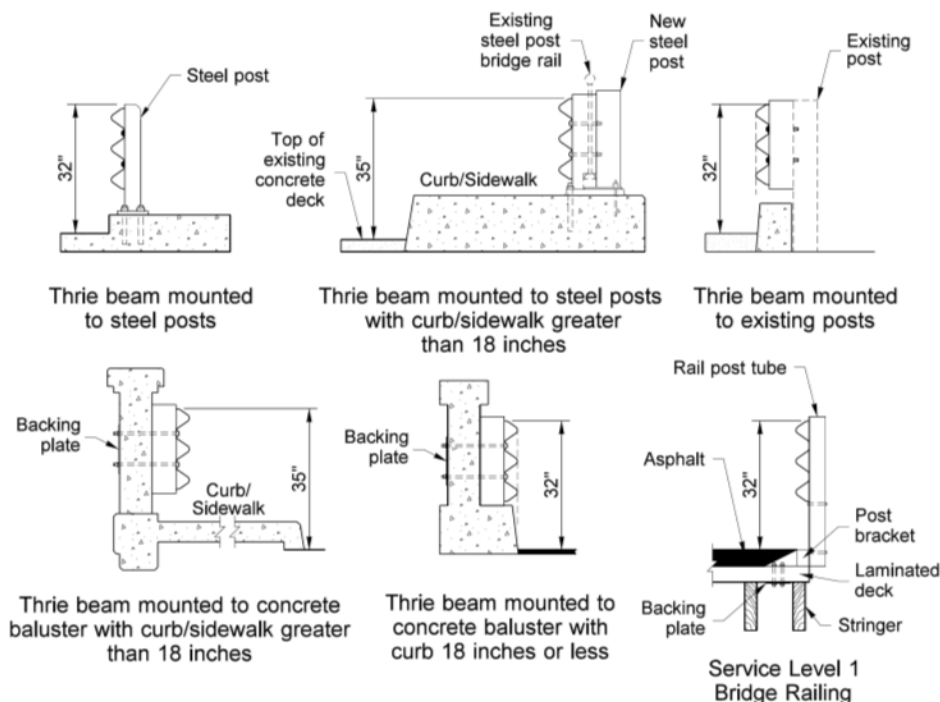

Notes:

- [1] To maximize available curb/sidewalk width for pedestrian use, thrie beam may be mounted to the bridge rail at a height of 35 inches.
- [2] Contact the WSDOT BSO for design details on bridge rail retrofit projects.

1610.08 Other Barriers

1610.08(1) Redirectional Landform

Redirectional landforms, also referred to as earth berms, were formerly installed to help mitigate crashes with fixed objects located in depressed medians and at roadsides. They were constructed of materials that provided support for a traversing vehicle. With slopes in the range of 2H:1V to 3H:1V, they were intended to redirect errant vehicles. The use of redirectional landforms has been discontinued. Where redirectional landforms currently exist as mitigation for a fixed object, provide alternative means of mitigation of the fixed object, such as remove, relocate, upgrade with crash-tested systems, or shield with barrier. Landforms may be used to provide a smooth surface at the base of a rock cut slope.

1610.08(2) Aesthetic Barrier Treatment

When designing a barrier for use on a Scenic Byway, consider barriers that are consistent with the recommendations in the associated corridor management plan (if one is available). Contact the region or HQ Landscape Architect Office to determine whether the project is on such a designated route. Low-cost options may be feasible, such as weathering agents, stains, colorants, or coatings applied to galvanized steel beam guardrail and its components. Higher-cost options, such as steel-backed timber rail and stone guardwalls, might necessitate a partnering effort to fund the additional costs. Grants might be available for this purpose if the need is identified early in the project definition phase.

1610.08(3) Steel-Backed Timber Guardrail

Steel-backed timber guardrails consist of a timber rail with a steel plate attached to the back to increase its tensile strength. There are several variations of this system that have passed crash tests. The nonproprietary systems use a beam with a rectangular cross section that is supported by either wood or steel posts.

A proprietary (patented) system, called the Ironwood Guardrail, is also available. This system uses a beam with a round cross section and is supported by steel posts with a wood covering to give the appearance of an all-wood system from the roadway. The incorporation of the Ironwood Guardrail will need to be documented. Consult with the Assistant State Design Engineer to determine what justification (proprietary or a public interest finding) will be required.

The most desirable method of terminating the steel-backed timber guardrail is to bury the end in a backslope, as described in 1610.04(5). When this type of terminal is not possible, use of the barrier is limited to highways with a posted speed of 45 mph or below. On these lower-speed highways, the barriers can be flared away from the traveled way as described in 1610.03(4) and terminated in a berm outside the Design Clear Zone.

For details on these systems, contact the HQ Design Office.

1610.08(4) Stone Guardwalls

Stone guardwalls function like rigid concrete barriers but have the appearance of natural stone. These walls can be constructed of stone masonry over a reinforced concrete core wall or of simulated stone concrete. These types of barriers are designed to have a limited textured

projection of the stones to help aid in the redirection characteristics of the barrier. The most desirable method of terminating this barrier is to bury the end in a backslope, as described in [1610.06\(3\)](#). When this type of terminal is not possible, use of the barrier is limited to highways with a posted speed of 45 mph or below. On these lower-speed highways, the barrier can be flared away from the traveled way and terminated in a berm outside the Design Clear Zone.

For details on these systems, contact the HQ Design Office.

1610.08(5) Dragnet

The Dragnet Vehicle Arresting Barrier consists of chain link or fiber net that is attached to energy absorbing units. When a vehicle hits the system, the Dragnet brings the vehicle to a controlled stop with limited damage. Possible uses for this device include the following:

- Reversible lane entrances and exits
- Railroad crossings
- Truck escape ramps (instead of arrester beds—see [Chapter 1270](#))
- T-intersections
- Work zones
- Swing span bridges

Coordinate with the HQ Design Office for design details.

1610.09 References

1610.09(1) Design Guidance

WSDOT Roadside Safety site: <http://www.wsdot.wa.gov/Design/Policy/RoadsideSafety.htm>

[Bridge Design Manual LRFD](#), M 23-50, WSDOT

[Roadside Design Guide](#), AASHTO, 2011 with Errata (July 2015)

[Standard Plans for Road, Bridge, and Municipal Construction](#) (Standard Plans), M 21-01, WSDOT

[Traffic Manual](#), M 51-02, WSDOT

1610.09(2) Supporting Information

[Manual for Assessing Safety Hardware \(MASH\)](#), AASHTO, 2009

[NCHRP 350](#), TRB, 1993

[Determining Length of Need](#). This e-learning course for WSDOT employees covers the “Length of Need,” which is a calculation of how much longitudinal barrier is necessary to shield objects on the roadside. Request this training via the web-based Learning Management System.

- 1620.01 General
- 1620.02 Design Criteria
- 1620.03 Selection Considerations
- 1620.04 Transportable Attenuators (Truck-Mounted and Trailer-Mounted)
- 1620.05 Older Systems
- 1620.06 Inertial Barrier Systems (Sand Barrels)

1620.01 General

Impact attenuator systems are protective systems that help aid an errant vehicle from impacting an object by either gradually decelerating the vehicle to a stop when hit head-on or by redirecting it away from the feature when struck on the side. These systems are used for rigid objects or other features that cannot be removed, relocated, or made breakaway.

Approved systems shall meet standardized testing defined in the American Association of State Highway and Transportation Officials (AASHTO) *Manual for Assessing Safety Hardware (MASH) as updated in 2016*. In addition, these devices shall have an acceptance letter from FHWA that certifies that the device meets the appropriate crash test criteria and is eligible for federal-aid reimbursement.

1620.02 Design Criteria

The following design criteria apply to new, existing, or reset permanent and temporary impact attenuators.

Impact attenuators are placed so that they do not present a feature that requires mitigating in relation to opposing traffic. For median and reversible lane locations, the backup structure or attenuator-to-object connection is designed to help in aiding opposing traffic from being snagged.

Avoid placement of curbs between attenuators and traffic. Refer to the specific attenuator manufacturer's instructions if considering placement of curbing between an attenuator and the travelled way. It is desirable that existing curbing be removed and the surface smoothed with asphalt or cement concrete pavement before an impact attenuator is installed. However, mountable curbs 4 inches or less in height may be retained depending on the feasibility of removal and as long as the manufacturer's installation requirements are met.

In general, attenuators are aligned parallel to the roadway.

Consult with the Area Maintenance Superintendent who will be maintaining the system prior to selecting the attenuator systems to include in a construction contract.

1620.03 Selection Considerations

WSDOT classifies impact attenuators as **permanent** (for final installations that will remain in place) or **temporary** (for systems that will be in place during work zone traffic control operations and then removed). Some impact attenuator systems can be used in **both** a temporary capacity and then in a final/permanent installation.

For approved systems to choose from, see the WSDOT Impact Attenuator Design page at http://www.wsdot.wa.gov/publications/fulltext/design/ProductFolder/PENDING_Impact_Attenuator_Design.docx.

Consider that each application is unique when selecting impact attenuators for use in particular applications. This applies to both permanent and temporary installations.

To select an appropriate impact attenuator system, the following factors must be assessed:

- Posted speed
- Operating speed
- Average daily traffic (ADT)
- Repair crew exposure
- Proximity to the roadway
- Anticipated number of yearly impacts
- Available space (length and width)
- Lifecycle Maintenance costs
- Initial cost
- Duration (permanent or temporary use)
- Portion of the impact attenuator that is redirective/gating (see [Exhibit 1620-1](#))
- Width of object to be shielded

Entries on the WSDOT Impact Attenuator Design page indicate whether the system is National Cooperative Highway Research Program (NCHRP) Report 350 or MASH-compliant. If it's determined that a MASH-compliant system is not available for the specific configuration required, document the selection of an NCHRP 350 system in the DDP.

When selecting the appropriate impact attenuator system, consider the portion that is designed to redirect vehicles during a side impact of the unit, such that fixed objects, either permanent or temporary (such as construction equipment), are not located behind the gating portion of these devices (see [Exhibit 1620-1](#)).

Exhibit 1620-1 Impact Attenuator Distance Beyond Length of Need

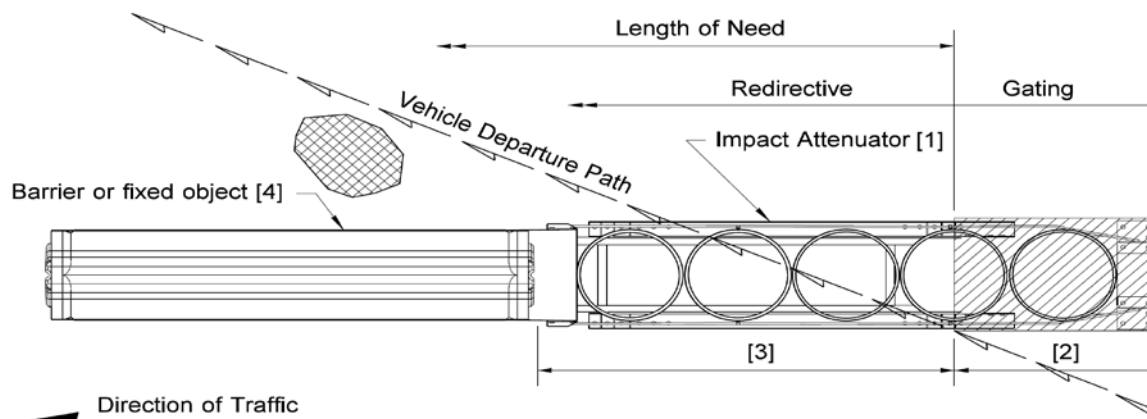
**Notes:**

- [1] Impact attenuator type and manufacturer varies with application. See the Attenuator Selection Template at:
http://www.wsdot.wa.gov/publications/fulltext/design/ProductFolder/Impact_attenuator_selection_template.xlsx
- [2] Distance beyond the length of need. This portion is gating.
- [3] This portion is redirective (nongating) and can be included as part of the barrier needed to satisfy length of need.
- [4] Concrete barrier shown for illustration purposes only. Type of fixed object varies.

Select the system and configuration appropriate for the posted speed. In the interest of a cost-effective design, selecting a system applicable for the posted speed is recommended (although using a system tested for a higher speed is acceptable). Note that attenuators used on highways with posted speeds of 70 mph have additional considerations discussed below. Where there is evidence that the average operating speed of the facility is higher than the posted speed, consider selecting an attenuator system rated at the facility's operating speed.

Manufacturer's product information may indicate that a different system is required for speeds of 70 mph or greater. These models are generally referred to as "high speed" or "70 mph" systems. Use of these systems on facilities with 70 mph posted speeds is not required, and selection of a system rated for at least 60 mph will typically be appropriate for most sites on these facilities. For permanent installations where unusual conditions warrant consideration of a high-speed device, these systems are available and may be used with justification. Contact the HQ Design Office for guidance when considering one of these systems.

For information regarding spatial requirements and initial cost information related to impact attenuator systems, see the Attenuator Selection Template at:
http://www.wsdot.wa.gov/publications/fulltext/design/ProductFolder/Impact_attenuator_selection_template.xlsx.

When considering maintenance costs, anticipate the average annual impact rate. If few impacts are anticipated, lower-cost devices might meet the need. (See [Chapter 301](#) for examples of how to determine lifecycle costs for proposed hardware). Attenuators with the lowest initial cost and initial site preparation will have high maintenance costs after each impact. Labor and equipment

are needed to clean up the debris and install a new attenuator, as the lowest cost attenuators are typically destroyed after a single impact. Attenuators with higher initial installation cost typically have lower maintenance costs.

In selecting a system, one consideration is the anticipated exposure to traffic that the workers making the repairs may encounter. In areas with high traffic exposure, a low-maintenance system that can be repaired quickly is most desirable. Some systems need nearly total replacement or replacement of critical components (such as cartridges or braking mechanisms) after a head-on impact, while others simply need to be reset.

When a transition to connect with a concrete barrier, fixed object, or beam guardrail is needed, the transition type and connection may need to be specified (see the impact attenuator descriptions accessible through the Attenuator Selection Template at:

http://www.wsdot.wa.gov/publications/fulltext/design/ProductFolder/Impact_attenuator_selection_template.xlsx).

In most cases, the transition type and connection required will be a custom design per the manufacturer (these transitions are included in the cost of the impact attenuator). In a few cases, the transition type and connection to use will be as described in [Chapter 1610](#) and the *Standard Plans* (these transition sections are not included in the cost of the impact attenuator and must be included as a separate bid item in the construction contract).

Consult with the Area Maintenance Superintendent who will be maintaining the systems before finalizing the list of attenuators to be included in the contract.

1620.03(1) Low-Maintenance Category

Low maintenance devices have a higher initial cost, requiring substantial site preparation, including a backup or anchor wall in some cases, and cable anchorage at the front of the installation. However, repair costs are very low, with labor typically being the main expense. Maintenance might not be needed after minor side impacts with these systems.

Installation of a low-maintenance device is desirable at locations that meet at least one of the following criteria:

- Sites with an ADT of 25,000 or greater
- Sites with a history/anticipation of more than one impact-per year
- Sites with unusually challenging conditions, such as limitations on repair time, a likelihood of frequent night repairs, or narrow gore locations

Document the decision in the DDP to use any device other than a low-maintenance device at locations meeting at least one of the criteria above.

The HQ Design Office conducts a periodic review of maintenance records to consider which devices should be included in the Low-Maintenance category. For a description of requirements that need to be met in order to be included in the Low-Maintenance category, see:

www.wsdot.wa.gov/publications/fulltext/design/roadsidesafety/low_maint.pdf

1620.03(2) Documenting Attenuator Selection

As the factors discussed previously are analyzed, identify inappropriate systems and eliminate them from further consideration. List the systems that are not eliminated in the contract. When the site conditions vary, it might be necessary to have more than one list of acceptable systems

within a contract. Acceptable systems cannot be eliminated without documented justification as to why they should not be used. Also, wording such as “or equivalent” is not to be used when specifying these systems. If it’s determined that MASH-compliant system is not available for a specific configuration, NCHRP 350 systems may be used, with Assistant State Design Engineer approval.

Document attenuator selection using the Attenuator Selection Template found at:

http://www.wsdot.wa.gov/publications/fulltext/design/ProductFolder/Impact_attenuator_selection_template.xlsx

1620.04 Transportable Attenuators (Truck-Mounted and Trailer-Mounted)

Truck Mounted Attenuators and Trailer-Mounted Attenuators are portable systems mounted on trucks or trailers. They are intended for use in work zones and for temporary applications.

1620.05 Older Systems

Many older systems are in use on Washington State highways and may be left in place or reset with concurrence of the WSDOT Area Maintenance Superintendent who maintains the system. New installations of these systems are not allowed.

For a list of older systems see:

http://www.wsdot.wa.gov/publications/fulltext/design/ProductFolder/PENDING_Impact_Attenuator_Design.docx.

1620.06 Inertial Barrier Systems (Sand Barrels)

Inertial barrel systems (sand barrels) commonly provide advantages in temporary installations where the locations change and there is sufficient space available or in permanent locations where there is a lower risk of collisions and where the debris, from the initial barrier when hit, will have a minimal impact to traffic. Refer to the manufacturer for system dimensions and specifications.

