



**Washington State
Department of Transportation**

TECHNICAL MANUAL

Utilities Manual

M 22-87.11

February 2025

Engineering and Regional Operations

Development Division, Design Office

Americans with Disabilities Act (ADA) Information

This material can be made available in an alternate format by emailing the WSDOT Diversity/ADA Affairs team at wsdotada@wsdot.wa.gov or by calling toll free: 855-362-4ADA (4232). Persons who are deaf or hard of hearing may make a request by calling the Washington State Relay at 711.

Title VI Notice to Public

It is Washington State Department of Transportation (WSDOT) policy to ensure no person shall, on the grounds of race, color, national origin, or sex, as provided by Title VI of the Civil Rights Act of 1964, be excluded from participation in, be denied the benefits of, or be otherwise discriminated against under any of its federally funded programs and activities. Any person who believes his/her Title VI protection has been violated may file a complaint with WSDOT's Office of Equal Opportunity (OEO). For Title VI complaint forms and advice, please contact OEO's Title VI Coordinator at 360-705-7082 or 509-324-6018.

To get the latest information on individual WSDOT publications, sign up for email updates at:
 www.wsdot.wa.gov/publications/manuals

Foreword

The *Utilities Manual* has been prepared to outline the general practices, policies, and procedures in the design, administration, and coordination of utilities and railroad facilities within Washington State Department of Transportation (WSDOT) properties or impacted by the department's highway projects. The intent is to provide consistent, current, and accurate guidance for users. Any requirements noted in this guidance are taken from the WSDOT *Utilities Accommodation Policy* and other documents as identified in the manual.

The previous revision of the *Utilities Manual*, which was issued in November 2014, is hereby superseded.

Updating the *Utilities Manual* is an ongoing process and revisions will be made yearly. Users should submit suggestions for additions or revisions to the Headquarters Utilities Specialist, listed in Headquarters Contacts at the Utilities, Railroads, and Agreements Home Page:

 www.wsdot.wa.gov/utilities/hq.htm

/s/ Ahmer Nizam

Ahmer Nizam
Technical & Business Manager,
WSDOT HQ Design Office

Contents

Chapter 1	Utility Accommodation	1-1
100	Administration and General Information	1-1
100.01	Utility Accommodation Program Purpose	1-1
100.02	Types of Utility Accommodation Documents	1-2
100.03	Installation Categories	1-4
100.04	Utility Classification Criteria	1-10
100.05	Accommodation Documents: Management and Administration . .	1-12
100.06	Approval Authority	1-13
100.07	Accommodation Process and Procedure	1-15
110	General Requirements	1-20
110.01	Accommodation Application Requirements	1-20
110.02	Franchise Consolidation and Franchise Renewal Process and Requirements	1-22
110.03	Fees and Reimbursable Accounts	1-27
110.04	Sureties	1-29
110.05	Local, State, or Federal Agencies	1-33
120	Specific Installation Requirements	1-35
120.01	Hearings	1-35
120.02	City Streets as Part of State Highways	1-35
120.03	Annexations and Route Jurisdiction Transfers	1-36
120.04	Pipelines	1-38
120.05	Storm Drainage and Hydraulics	1-47
120.06	Open Cuts and Trenching	1-49
120.07	Bridges and Structures	1-54
120.08	Scenic Classification Policy	1-62
120.09	Control Zone	1-65
120.10	Joint-Use and Future-Use Utilities	1-66
120.11	Access Control	1-67
120.12	Environmental Considerations	1-68
120.13	Utility Maintenance	1-70
120.14	Variances: Types, Treatment, and Approval	1-70
120.15	Casing, Conduit, Innerduct, and Encasement	1-75
130	Post-Approval Administration	1-79
130.01	Addenda to Approved Accommodation Documents	1-79
130.02	Extension of Installation Time	1-83
130.03	As-Builts: Record Drawings	1-84
130.04	Penalties	1-84
130.05	Utility Transfer of Ownership – Acceptance of Assignment	1-85
130.06	Abandoned, Deactivated, or Disconnected Utilities	1-87
130.07	Undocumented Utility Installations	1-88
130.08	Turnback Areas and Construction Permits	1-89
130.09	Compliance Reviews	1-91

Chapter 2	Utility Agreements	2-1
	200.01 General	2-1
	200.02 Utility Property Rights	2-3
	200.03 Preliminary Engineering Agreements	2-6
	200.04 Construction Agreements	2-14
Chapter 3	Railroads	3-1
	300.01 General	3-1
	300.02 Responsibilities	3-1
	300.03 Railroad Requirements	3-2
	300.04 Railroad Crossings	3-4
Chapter 4	Intentionally Omitted	4-1
Chapter 5	Government Agencies: State, Federal, Tribal, and Other Entities	5-1
	500.01 General	5-1
	500.02 State Agencies	5-1
	500.03 Federal Agencies	5-2
	500.04 Tribal Authorities	5-8
	500.05 Railroad Companies	5-9
Chapter 6	Project Delivery and Utility Relocation	6-1
	600.01 General	6-1
	600.02 Schedules, Goals, and Strategies	6-3
	600.03 Early Utility Identification	6-3
	600.04 Coordination, Cooperation, and Communication	6-3
	600.05 Roles and Responsibilities	6-5
	600.06 Cost Responsibility and Recovery	6-6
	600.07 Coordination Milestones	6-8
	600.08 Project Initiation: Project Design Notification	6-8
	600.09 Geometric Review (30%)	6-8
	600.10 Subsurface Utility Engineering (SUE)	6-14
	600.11 Preliminary Engineering Agreements	6-22
	600.12 General Plans Review (60%)	6-22
	600.13 Preliminary Contract Review (90%)	6-26
	600.14 Preadvertisement	6-27
	600.15 Design/Construction Utility Relocation Facilitation	6-27
	600.16 Project Award and Construction	6-28
	600.17 Developer Projects and Utility Relocation	6-29

Chapter 7	Inspection	7-1
	700.01 General	7-1
	700.02 Jurisdiction and Authority	7-2
	700.03 Traffic Control and Safety	7-4
	700.04 Buried Facilities	7-6
	700.05 Aboveground Facilities	7-7
	700.06 Bridge Attachments	7-7
	700.07 Environmental Requirements	7-8
	700.08 Communication With Others	7-9
	700.09 Documentation	7-11
Chapter 8	Reimbursement	8-1
	800.01 General	8-1
	800.02 Utility Accommodation Reimbursement Policy	8-1
Chapter 9	Control Zone Guidelines	9-1
	900.01 General	9-1
	900.02 Clear Zone vs. Control Zone	9-1
	900.03 Control Zone Objective	9-2
	900.04 Definitions	9-2
	900.05 Application	9-2
	900.06 Control Zone Distance	9-3
	900.07 Recovery Area	9-10
	900.08 Supplemental Utility Design Information	9-11
	900.09 Project Applications	9-13
	900.10 Completing the Utility Object Relocation Record	9-14
	900.11 Variance	9-15
	900.12 Variance Request for Location I Objects	9-16
	900.13 Variance Request for Location II Objects	9-16
 Appendices		
	Appendix A Glossary	A-1
	Appendix B Utility Forms and Documents	B-1
	Appendix C Policy Guidance	C-1
	Appendix D RCW and WAC References	D-1

This page was intentionally left blank.

- 100 Administration and General Information
- 110 General Requirements
- 120 Specific Installation Requirements
- 130 Post-Approval Administration

100 Administration and General Information

100.01 Utility Accommodation Program Purpose

This chapter provides guidance on the importance of the management and administration of the Washington State Department of Transportation's (WSDOT's) Utility Accommodation Program. The priorities controlling utility accommodation within the highway operating right of way are:

- The safety of the traveling public.
- The needs, mission, and priorities of the department.
- The needs of utility owners.

The policies and guidelines in this chapter outline the requirements and expectations for installation of utilities within the highway operating right of way. They are intended to illustrate the process, for both WSDOT and the utility owner, to produce an accurate utility accommodation document.

Nothing in this chapter is intended to limit the rights of WSDOT to impose additional restrictions or requirements on a utility installation if deemed appropriate, advisable, or necessary by the department to do so.

(1) Impacts and Requirements

Identify the immediate construction impacts and potential long-term effects of proposed utility installations upon the highway operating right of way, and ensure those installations meet the requirements of WSDOT's *Utilities Accommodation Policy*.

(2) Utility Location

Maintain accurate and up-to-date records of the location of authorized utilities installed within the right of way.

(3) Utility Ownership

Maintain accurate and up-to-date records of utility ownership.

RCW 47.44
WAC 468-34

100.02 Types of Utility Accommodation Documents

RCW 47.44.010
RCW 47.56.256
WAC 468-34-110

Utility accommodation documents define utility ownership, type, size, location, construction methods, maintenance frequency and duration, and other information considered necessary by the department. WSDOT processes utility accommodation documents related only to utility installations on operating highway rights of way, toll facilities, and the state ferry system. Utility accommodation documents used for this purpose include the following forms:

- Utility Franchise
- Franchise Consolidation
- Franchise Renewal
- Franchise Amendment
- Utility Permit

Refer to [110.01](#), Accommodation Application Requirements, for guidance on the use of the above forms.

(1) Utility Franchise

Utility franchises are the primary utility accommodation document used for recording utility installation details authorized within the operating highway right of way and its facilities based on the Utility Classification Criteria (see [100.04](#)). Use DOT Form 224-696, Utility Accommodation Application (see [Appendix B](#), Utility Forms and Documents).

- (a) **Franchise Use** – Use utility franchises to describe utilities installed across, along, or within the operating highway right of way or its facilities.
- (b) **Franchise Duration** – Utility franchises authorize utility occupation within the operating highway right of way for any duration up to, but not exceeding, 25 years. Franchise Renewal (also “Renewal”) is required prior to the franchise expiration date for the franchise to remain valid. (See [100.07\(1\)\(c\)](#), Consolidations and Renewals for additional information.)

(2) Franchise Amendment

A Franchise Amendment is a utility document that extends, supplements, or modifies an existing utility franchise based on the Utility Classification Criteria. Use DOT Form 224-696, Utility Accommodation Application (see [Appendix B](#)).

- (a) **Franchise Amendment Duration and Expiration Date** – Utility Franchise Amendments authorize utility occupation within the operating highway right of way for any duration up to, but not exceeding, 25 years, unless an extension is granted due to unique circumstances.

Franchise Amendment expiration is tied to the parent franchise, the expiration date of a Franchise Amendment shall be the same as that of the original franchise. When the parent or original franchise expires, so do all amendments to that franchise.

Franchise Renewal is required prior to the franchise expiration date for the franchise to remain valid. (See [100.07\(1\)\(c\)](#), Consolidations and Renewals for additional information.)

RCW 47.44.020

(3) Franchise Consolidation

A Franchise Consolidation (also “Consolidation”) is a grouping process that combines multiple franchises, Franchise Amendments, previous Consolidations, and utility permits into a single franchise document based on the Utility Classification Criteria. Consolidations are recommended, not required, for continued installation of utilities within the operating highway right of way by utility companies. In order to meet the goals of the Utility Classification Criteria, the Consolidation process should be approached with an attitude of partnership and cooperation with the utility owner. Use DOT Form 224-696, Utility Accommodation Application (see [Appendix B](#)).

- (a) **Franchise Consolidation Use** – To maintain historical records of superseded documents, list all existing accommodation documents superseded by the Consolidation as a separate exhibit.

Assign all Franchise Consolidations a new document number. The new number should end with a “C” to differentiate the Consolidation document from non-Consolidation accommodation documents.

- (b) **Franchise Consolidation Duration** – Franchise Consolidations authorize utility occupation within the operating highway right of way for any duration up to, but not exceeding, 25 years.

(4) Franchise Renewal

Franchise Renewal is an updating process that renews a previously approved utility franchise prior to the franchise expiration date. In order to be eligible for Renewal, a franchise must meet specific qualifications and must meet the definition of the Utility Classification Criteria (see [100.04](#)). (See [100.07\(1\)\(c\)](#), Consolidations and Renewals for additional information.) Use DOT Form 224-696, Utility Accommodation Application (see [Appendix B](#)), when renewing existing utility franchises.

[WAC 468-34-170](#)

- (a) **Utility Franchise Renewal Use** – Prior to the expiration of a franchise, the utility installation should be field-reviewed and the franchise updated to reflect existing conditions in the field. WSDOT should verify the installation meets current highway safety requirements and utility accommodation policies. To differentiate the Renewal document from other accommodation documents, use the existing utility franchise number, supplemented by an “R” at the end of the franchise number.
- (b) **Utility Franchise Renewal Duration** – Franchise Renewal duration is the same as for a new franchise, provided that any issues identified during the Renewal review and approval process have been resolved. (See [100.07\(1\)\(c\)](#), Consolidations and Renewals for additional information.)

(5) Utility Permit

A utility permit is a secondary utility document used to define a utility installation that:

- Crosses the operating highway right of way normal to centerline or at a skew angle no greater than 45 degrees offset from normal.
- Is longitudinal to the right of way and is no greater than 300 feet in length as measured along the highway centerline.

[RCW 47.44.050](#)

[WAC 468-34-130\(3\)](#)

WAC 468-34-100

- (a) **Utility Permit Use** – Use a permit as a secondary utility accommodation document to define utility ownership, type, size, location, construction methods, maintenance frequency and duration, and other information considered necessary by WSDOT.

Every effort should be made to associate a proposed utility installation with an existing utility franchise based on the Utility Classification Criteria. Conduct thorough research before eliminating a franchise or Franchise Amendment as the method of documenting the proposed utility installation.

Use a permit only when research indicates there is no franchise within the Utility Classification Criteria (see 100.04) that can be amended and that the definition of a franchise or Franchise Amendment cannot be met.

- (b) **Utility Permit Duration** – Utility permits have no expiration date. As such, any permits allowing utilities within the operating highway right of way should be thoroughly reviewed for impacts to planned or potential highway improvement projects or other impacts prior to approval.

(6) Informational Accommodation Documents

Informational utility accommodation documents are used to record utilities owned by WSDOT. These installations may include telecommunications, intelligent transportation system (ITS) facilities, power, water, sewer, or other utilities.

Informational utility accommodation documents may also be used to identify utility crossings or installations that have a compensable property right and for which a WSDOT franchise or permit is not appropriate.

Assign accommodation document numbers to informational accommodation documents the same as any other accommodation document. Appropriate reviews should be conducted and as-built information obtained whenever possible. Application fees and reimbursable accounts do not apply. Charge code information may be obtained from project offices by each region, as necessary.

Enter informational accommodation documents into the Utility Franchise Permit (UFP) system when the information document and installation are completed. Hard copy files should be stored similar to other utility-owned utility accommodation documents.

100.03 Installation Categories

RCW 47.44.010

Proposed utility installations within the operating highway right of way are categorized based on the impact the installation will have upon the safety, continued operation, and future improvement of the transportation facility. Impacts due to the construction, maintenance, expansion, connection to, and/or relocation of the utility must all be taken into consideration when reviewing utility accommodation applications. The primary focus of WSDOT's review should be on the safe movement of traffic by requiring that the utility be installed in the least intrusive location and constructed using the least intrusive construction method. Visual quality, engineering principles, and overall economic impacts should also be considered.

WAC 468-34-130

Generally, all longitudinal utility installations should be located as close as possible to the right of way line. Crossings should be placed as normal to the highway center-line as possible. Depth and height requirements must be met as defined in this manual and applicable state/federal codes and publications. WSDOT may restrict the number and method of service connections based on the safety and operation of the highway.

Utilities installed for a highway purpose, such as for highway illumination, rest areas, telecommunications, or other facilities, shall meet the requirements of this manual and the *Utilities Accommodation Policy*. (See 100.02(6), Informational Accommodation Documents, for further guidance.)

WAC 468-34-130(7)
WAC 468-34-110(52)

(1) *Applications With Multiple Installation Categories*

It is possible the proposed work could meet the definition of more than one category. When this occurs, the most stringent category shall apply to the entire application.

(2) *Installation Category Types and Descriptions*

The following definitions generally describe each category. Refer to Figures 100-1 through 100-6 for a graphic representation of categories.

(a) **Installation Category 1: Considerable Impact** – Utility installations within this category include any or all of the following situations or conditions:

WAC 468-34-110(53)(a)

- Longitudinal installation located between the centerline and a point 5 feet beyond outside edge of pavement or back of guardrail post.
- Longitudinal installations within any median.
- Longitudinal installations within any limited access controlled highway.
- Aerial installations within Scenic Class A or B.
- Installations requiring open cuts of the paved roadway.
- Any trenchless construction highway crossings exceeding 36”.
- Aboveground installations for which a Control Zone variance approval is required.
- Installations attached to any bridge or structure.
- Buried installations located within the Zone of Influence of a bridge footing (see Figure 120-6).
- Installations contrary to the requirements of the *Utilities Accommodation Policy*.

(b) **Installation Category 2: Limited Impact** – Utility installations within this category may include, but are not limited to, any or all of the following situations or conditions:

WAC 468-34-110(53)(b)

- Longitudinal installations located **within** an area described as: The horizontal distance 5 feet beyond the outside edge of pavement or back of guardrail post to the bottom of ditch or toe of slope **plus** either 10 feet or the horizontal distance to a point within 5 feet of the right of way line, whichever is less.
- Installations for which an individual bond is required.
- Installations requiring a Notice of Filing.
- Installations requiring environmental permitting or documentation.
- Limited access highway crossings.
- Limited access nonexempt same-side service connections.
- Installations involving storm drainage.

WAC 468-34-110(53)(c)

(c) **Installation Category 3: Little or No Impact** – Utility installations within this category may include, but are not limited to, any or all of the following situations or conditions:

- Longitudinal installations located **beyond** an area described as: The horizontal distance 5 feet beyond the outside edge of pavement or back of guardrail post to the bottom of ditch or toe of slope **plus** either 10 feet or the horizontal distance to a point within 5 feet of the right of way line, whichever is less.
- Nonexempt same-side service connections.
- Non-limited access highway crossings.
- Aboveground installation complying with WSDOT's Control Zone Policy.
- Installations involving a change in the size or capacity of existing facilities located within existing conduits or on existing poles.

All construction work and methods necessary for Category 3 installations, such as bore pits, shoring, trenching, staging of equipment or materials, and so on, should occur within the area defined as Category 3, as illustrated in Figures 100-5 and 100-6.

WAC 468-34-110(53)(d)

(d) **Installation Category 4: Exempt Same-Side Service Connection** – Utility installations within this category include same-side service connections in non-limited access that meet ALL of the following conditions and requirements:

1. The same-side service connection does not exceed the following quantity or capacity:

<u>Power</u>	<u>15 kV</u>
<u>Telephone- copper</u>	<u>25 pair or less</u>
<u>Coaxial</u>	<u>1-inch or less</u>
<u>Fiber Optic</u>	<u>4-inch casing or less</u>
<u>Natural Gas</u>	<u>1¼-inch ID or less</u>
<u>Gravity Sewer</u>	<u>4-inch ID or less</u>
<u>Force Sewer</u>	<u>2-inch ID or less</u>
<u>Water</u>	<u>1½-inch ID or less</u>

2. These installations will not require a permit, provided that:
 - Longitudinal installations do not exceed 26 feet in length.
 - The service originates from an existing current franchise or permit.
3. Associated construction activity must occur within the area defined as Category 3, as shown in Figures 100-5 and 100-6.
4. WSDOT may restrict the number and method of service connections based on the safety and operation of the highway.
5. The utility shall submit a Category 4 Installation Authorization (Notice of Compliance) form to the region Utilities Office.

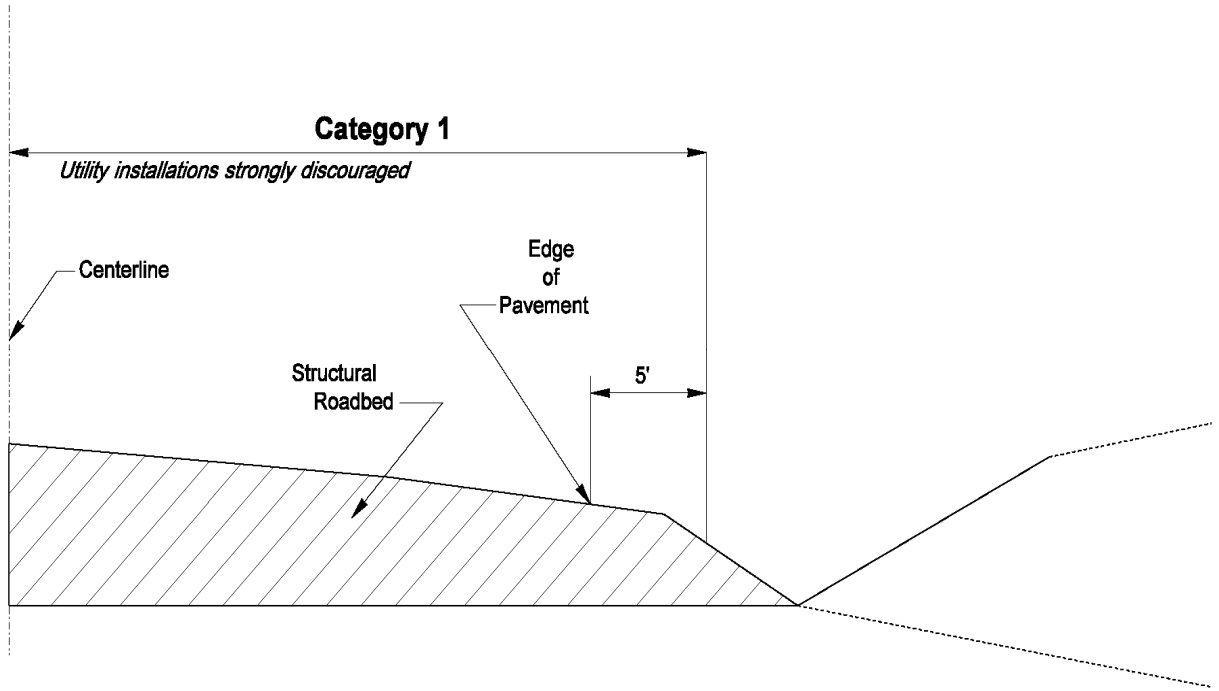

Installation Category 1
Figure 100-1

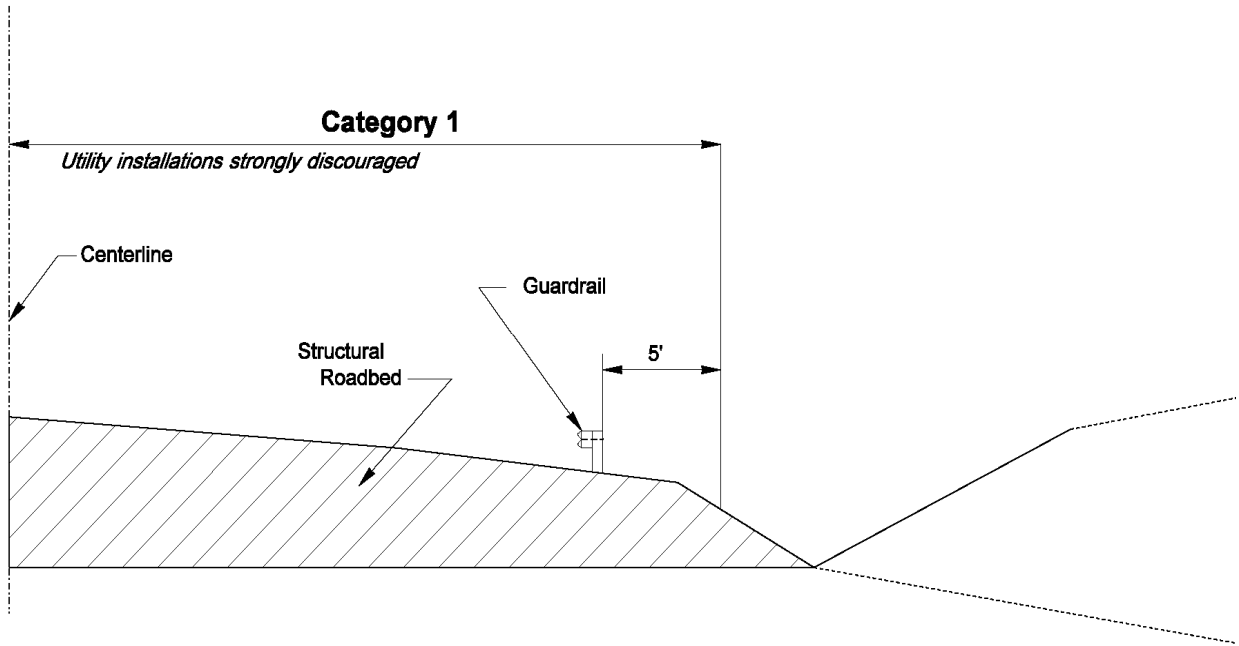

Installation Category 1: With Guardrail
Figure 100-2

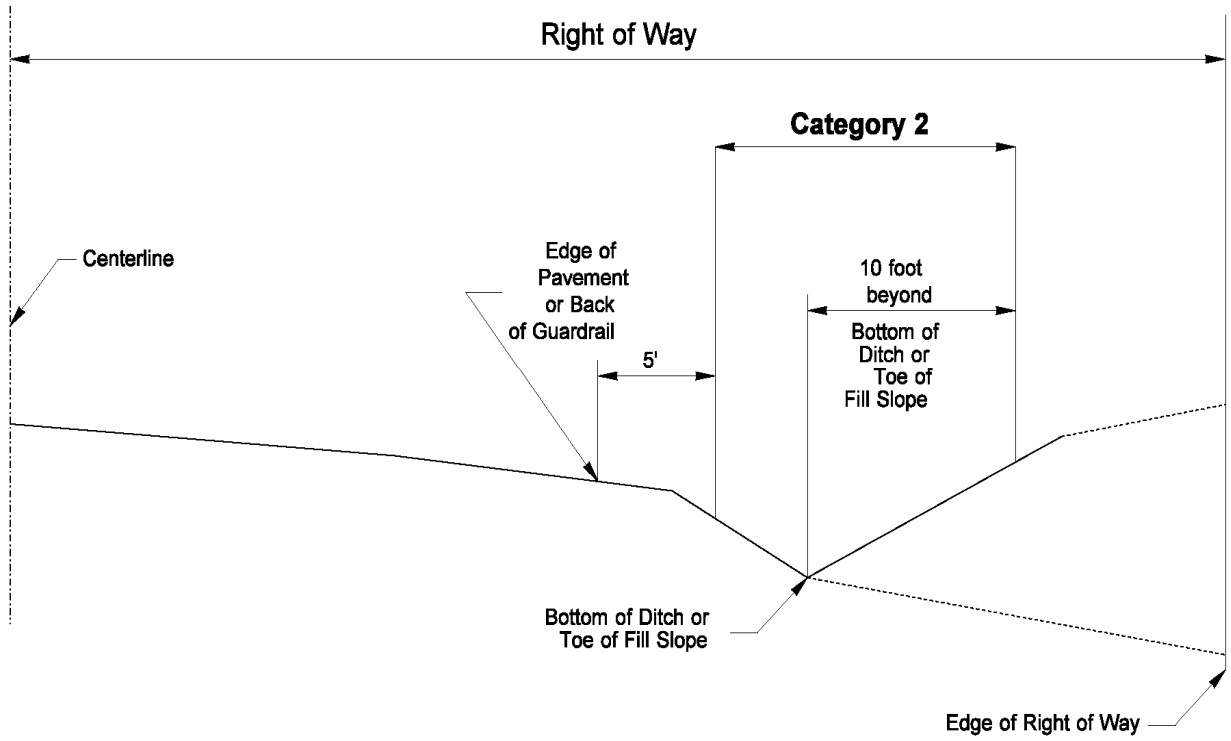

Installation Category 2: Standard Right of Way
Figure 100-3

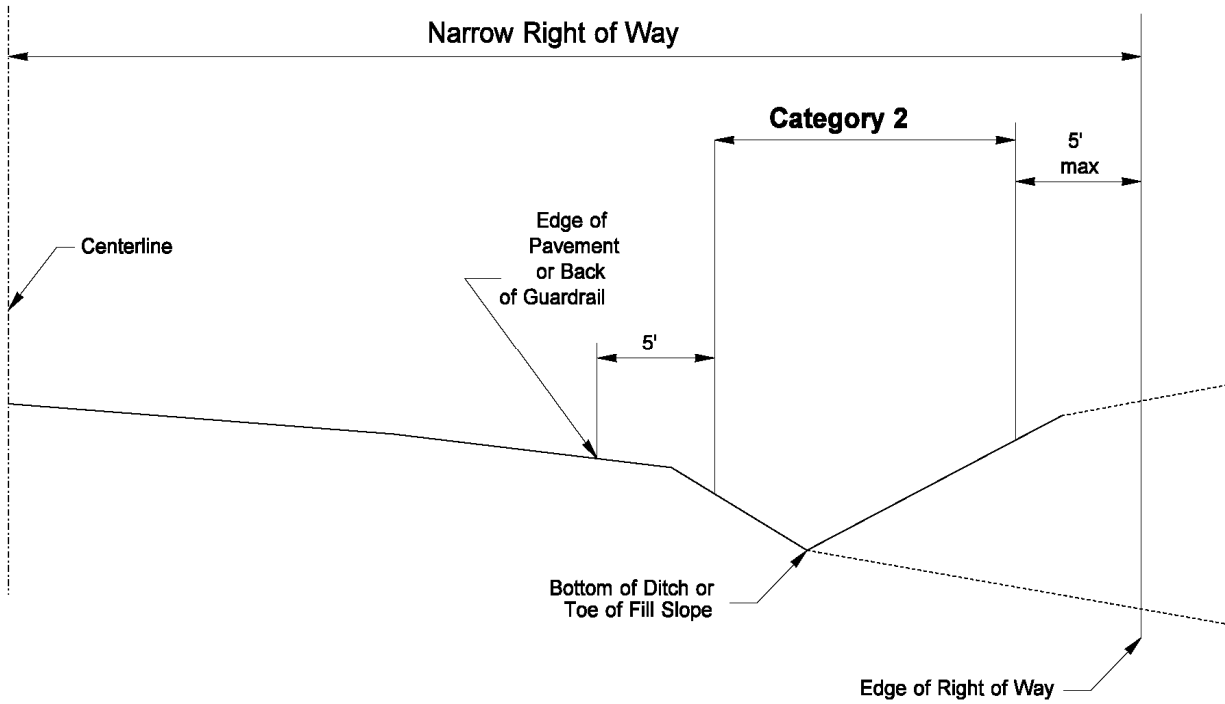

Installation Category 2: Minimal (Narrow) Right of Way
Figure 100-4

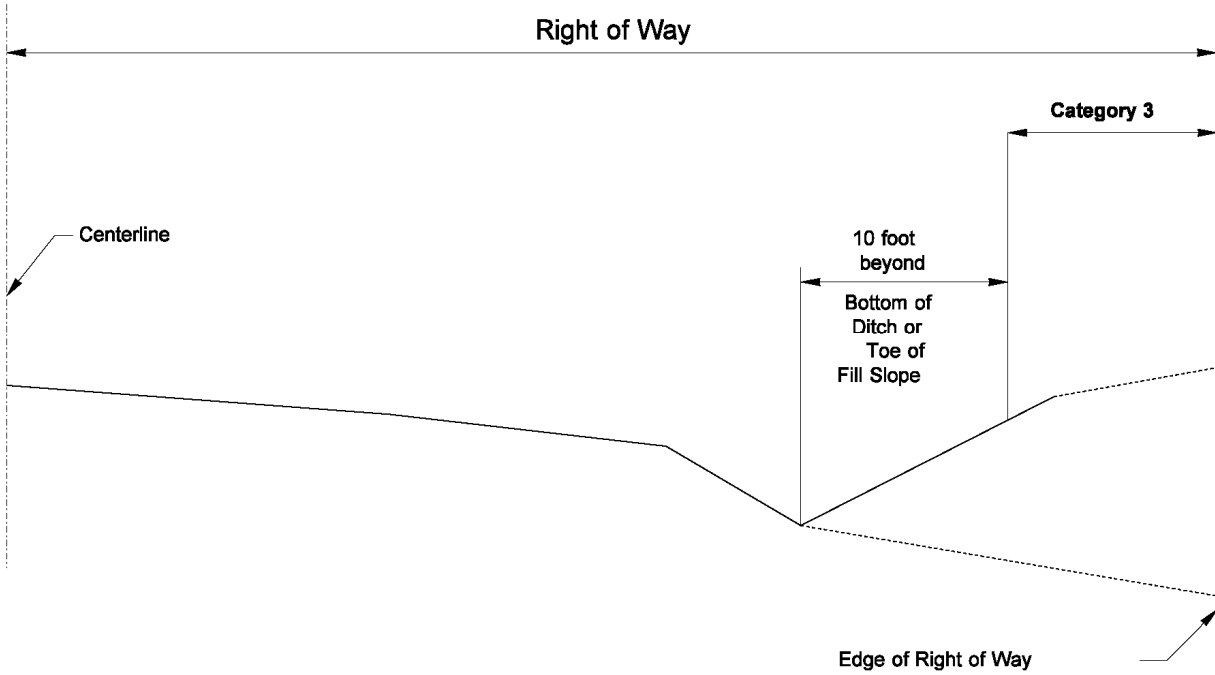

Installation Category 3: Standard Right of Way
Figure 100-5

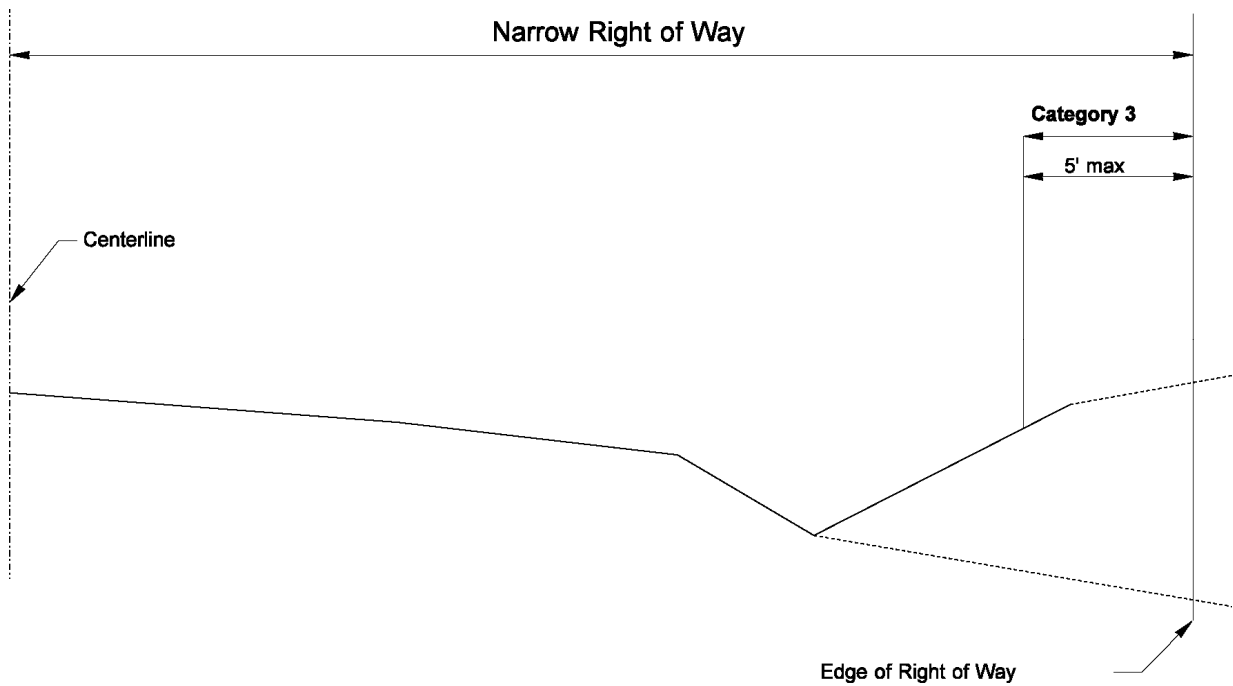

Installation Category 3: Minimal (Narrow) Right of Way
Figure 100-6

100.04 Utility Classification Criteria

The following four elements constitute the Utility Classification Criteria (also Classification Criteria) for all utility accommodation documents:

- Highway Number
- County
- Utility Type
- Utility Owner

The Utility Classification Criteria recommendation is that only one franchise be issued to each utility owner for each type of utility, within each county or section of county, on each highway. Once a franchise is issued, each additional utility accommodation application will be treated as an amendment to the original franchise based on the Classification Criteria.

(1) Purpose of Classification Criteria

The Utility Classification Criteria has two primary purposes. The first is to reduce the number of existing utility accommodation documents currently being administered by WSDOT through the Franchise Consolidation process. The second purpose is to provide clear and consistent guidance for the administrative processing and management of utility accommodation applications received by the department.

(2) Implementation and Use of Classification Criteria

Each new utility accommodation application shall meet the Classification Criteria. The key to new accommodation applications meeting the Classification Criteria is the status of existing utility franchises. Three conditions dictate the treatment of new and existing accommodation documents.

When a utility accommodation application is received by WSDOT, a determination will be made regarding which of three conditions the application falls under as defined in [Figure 100-7](#), Accommodation Document Classification.

- (a) **Condition 1** – If a franchise is available as defined by the Classification Criteria and the franchise is current (not expired), the application should be processed as an amendment to that franchise.
- (b) **Condition 2** – If a franchise exists, but is expired, the Franchise Consolidation process must be completed for approval of the utility accommodation application. This condition will have an effect upon other existing franchises and permits within the Classification Criteria, as described in [110.02](#), Franchise Consolidation and Franchise Renewal Process and Requirements.
 1. **Condition 2 Exception** – If implementing the Classification Criteria under Condition 2 will cause a delay in the delivery of a highway improvement project, WSDOT should work cooperatively with the utility to create a Consolidation Plan that avoids project delays. (See [110.02](#), Franchise Consolidation and Franchise Renewal Process and Requirements, for detailed guidance.)
- (c) **Condition 3** – If no franchise exists, a new franchise should be created using the Utility Classification Criteria. Alternatively, if the proposed utility installation does not meet the definition of a franchise, a utility permit may be issued.¹

¹Permits should be issued only if there is little chance of another application being received that would fall within the area defined by the Utility Classification Criteria. (See [100.02\(5\)](#) for detailed guidance.)

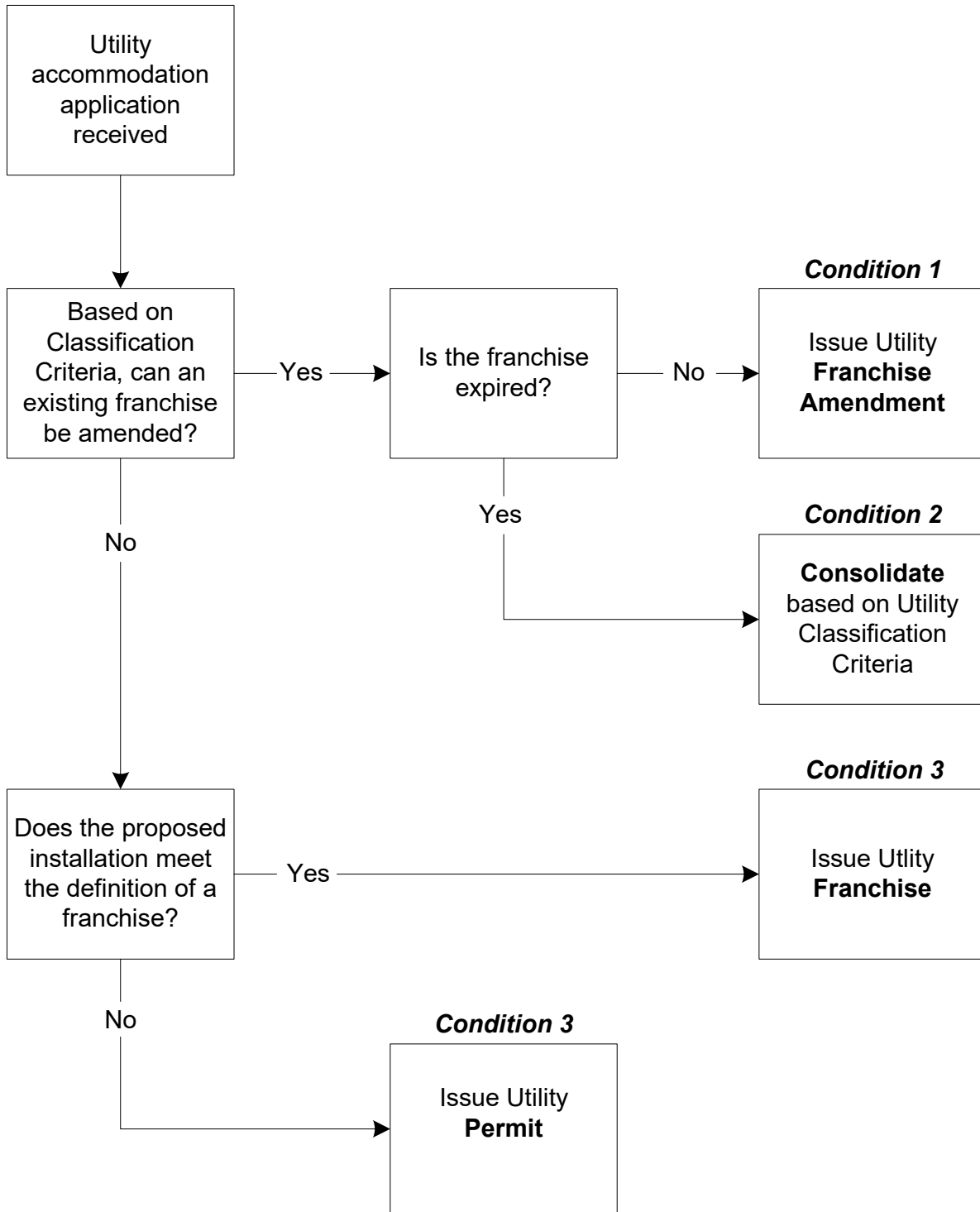

Accommodation Document Classification
Figure 100-7

100.05 Accommodation Documents: Management and Administration

(1) Region Documentation

WSDOT Policy

All regions are responsible for maintaining utility accommodation documentation for every utility installation located within their operating highway right of way. Supporting documentation should include, but is not limited to:

- Approved accommodation documents.
- Correspondence.
- Variance justification and supporting documentation.
- Appropriate decision-making documentation such as diaries, notes, letters, emails, and so on, that substantiate the decision-making and approval processes.
- Utility plans and details.
- Other plans and details such as Traffic Control Plans (TCP), Stormwater Pollution Prevention Plans (SWPPP), and other plan requirements.
- Surety information.
- Accounting details such as J-account information, copies of checks or check receipts, reimbursable account agreements, and other documents.
- Inspection information and details such as Inspector's Daily Reports (IDR) and materials reports.
- Checklists.
- Region and Headquarters (HQ) review approvals.
- Meeting agendas, notes, and action items.
- Research information.
- Other pertinent information.

(2) General Utility Company Documentation

Best Practice

Regions should also consider maintaining files for individual utility customers. Customer files should be used to track general agreements, letters of clarification or understanding, commitments made with WSDOT or the utility, utility system plans, or other general utility company information or correspondence that may be generated by day-to-day business and that is not specific to a particular accommodation document file.

(3) Headquarters Documentation

HQ Utilities functions as a statewide coordination office and, as such, generally maintains only limited and temporary accommodation-related files. Headquarters responsibilities include:

- Blanket surety files.
- Utility Transfer of Ownership (Acceptance of Assignment) files of significance.
- Compliance reviews.
- Historical records.
- Management of statewide utility-related databases.

100.06 Approval Authority

Approval for all utility accommodation documents and related administrative documents is delegated as defined in this section (see [Appendix B, Authority Matrix](#)).

(1) Headquarters Approval

The following documents and conditions require approval by the HQ Utilities, Railroad, and Agreements Manager, as delegated by the State Design Engineer. Further delegation is not allowed.

(a) Headquarters-Executed Administrative Documents

- Blanket sureties.
- Transfer of Ownership for utilities for which WSDOT holds a blanket surety unless the utility is fully within one region; that region has approval, but must notify Headquarters. (See [130.05](#), Utility Transfer of Ownership – Acceptance of Assignment, for detailed guidance.)

(b) Headquarters-Approved Accommodation Variance Documents: Federal Highway Administration (FHWA) Concurrence – FHWA review and concurrence is required for the following utility installations proposed within interstate rights of way:

- Open cuts.
- Longitudinal installations within any median.
- Construction and maintenance site access from freeway ramps or main line.
- Any proposal seeking to establish a permanent access break for regular access to the facility for the term of the franchise or permit.

Note: FHWA should be notified (as information only) whenever any utility work requires a rolling slow down or lane closures on an interstate. Contact HQ Utilities to facilitate this notification.

(c) Headquarters-Approved Accommodation Variance Documents – All variances within full control limited access rights of way require review and approval by Headquarters. These variances include:

- Uncased installations involving pressurized carrier pipes and carriers of transmittants, other than natural gas, that are flammable, corrosive, expansive, energized, or unstable.
- Longitudinal utility installations within full control limited access rights of way (as defined in [WAC 468-34-130\(3\)](#)).
- Access breaks for utility accommodation variances from property adjacent to fully controlled access rights of way. (Access break review and approval will be coordinated with the HQ Access and Hearings Section. For access break requests for utilities without variances, an informational copy of the request should be sent to [HQ Utilities](#).)
- Construction and maintenance site access from main line in fully controlled access rights of way.
- Aerial installations proposed in areas designated as Scenic Class A or B.

Refer to [120.14](#), Variances: Types, Treatment, and Approval, for detailed guidance and requirements for proposed variance installations.

Regions should contact [HQ Utilities](#) as early as possible in the application review process when any utility application or proposed variance requires Headquarters approval. Discuss the details of the proposed installation and the reason for the variance to verify what information is required to receive approval of the proposed utility installation.

(2) Region Approval

The following documents and conditions require approval by a Regional Administrator or a delegated authority. Delegation of authority is established for the Regional Administrator's direct report staff in writing by each Regional Administrator.

(a) Region-Approved Accommodation Documents

- Crossing installations within full control limited access right of way that do not involve a break in access.
- Any accommodation document within a modified, partial, or non-limited access controlled highway that does not involve a variance to WSDOT's *Utilities Accommodation Policy*. (See [120.14](#), Variances: Types, Treatment, and Approval, for detailed information on variance types and treatment.)
- Longitudinal installations within any non-limited access highway except those proposed to be installed within any median.
- Aerial installations within Scenic Classes C and D and nonvariance installations as determined by the region within Scenic Classes AX and BX. (See [120.08](#), Scenic Classification Policy, for detailed guidance.)
- Aboveground installations classified as Location III utility objects.

(b) Region-Approved Variance Accommodation Documents

- Longitudinal utility installations within partial or modified limited access highways.
- Utility installations using open trench construction methods, other than interstate, involving uncased pipes transmitting material, other than natural gas, that is flammable, corrosive, expansive, energized, or unstable. All other uncased installations require Headquarters approval.
- Crossings of fully controlled limited access highways.
- Roadway installations proposing to open cut the existing paved roadway.
- Utilities installed within the area defined as Category 1 (see Figures [100-1](#) and [100-2](#)).
- Installations that are proposed to be installed at less than the minimum required depth. (See [120.04](#), Pipelines, for minimum depth requirements.)

(c) Region-Executed Administrative Documents

- Individual sureties.
- Utility Transfer of Ownership for utilities limited to utility installations within individual regions' boundaries. (See [130.05](#), Utility Transfer of Ownership – Acceptance of Assignment, for detailed guidance.)
- Notice of Filing required for utility installations that require advertisement of an opportunity for a hearing. (See [120.01](#), Hearings, for detailed guidance.)

- (d) **Region Approval Requirements** – All region-approved documents must meet, as applicable, the following criteria:
- Installation is in accordance with the *Utilities Accommodation Policy*.
 - No objection to the installation has been filed by a third party.
 - No dispute exists between WSDOT and the applicant with respect to the acceptability of the proposed installation.
 - Access plan revision has been approved for routine maintenance of the utilities facility.
 - A utility service access road will not be constructed.
 - All aboveground utility objects are classified as Location III Objects.

100.07 Accommodation Process and Procedure

The utility accommodation process varies in duration and complexity depending on the proposed installation's impact to highway facilities and its compliance with WSDOT's utility accommodation requirements. The process described in this section is generic in nature. Differences in application processing will exist between regions and from one application to another.

In general, all applications go through a four-step process between the time the initial application is received and the utility installation certification process is completed. This four-step process can be as short as several weeks for a simple utility service connection or as long as several years, depending on the nature and complexity of the proposed utility installation. The four basic steps in the utility accommodation process are:

Step 1 Application Research and Review

Step 2 Application Approval

Step 3 Construction Authorization and Utility Installation

Step 4 Inspection, Certification, and Surety Release

Refer to [Figure 100-8](#), Utility Accommodation Process, for a flow chart outlining this four-step application process.

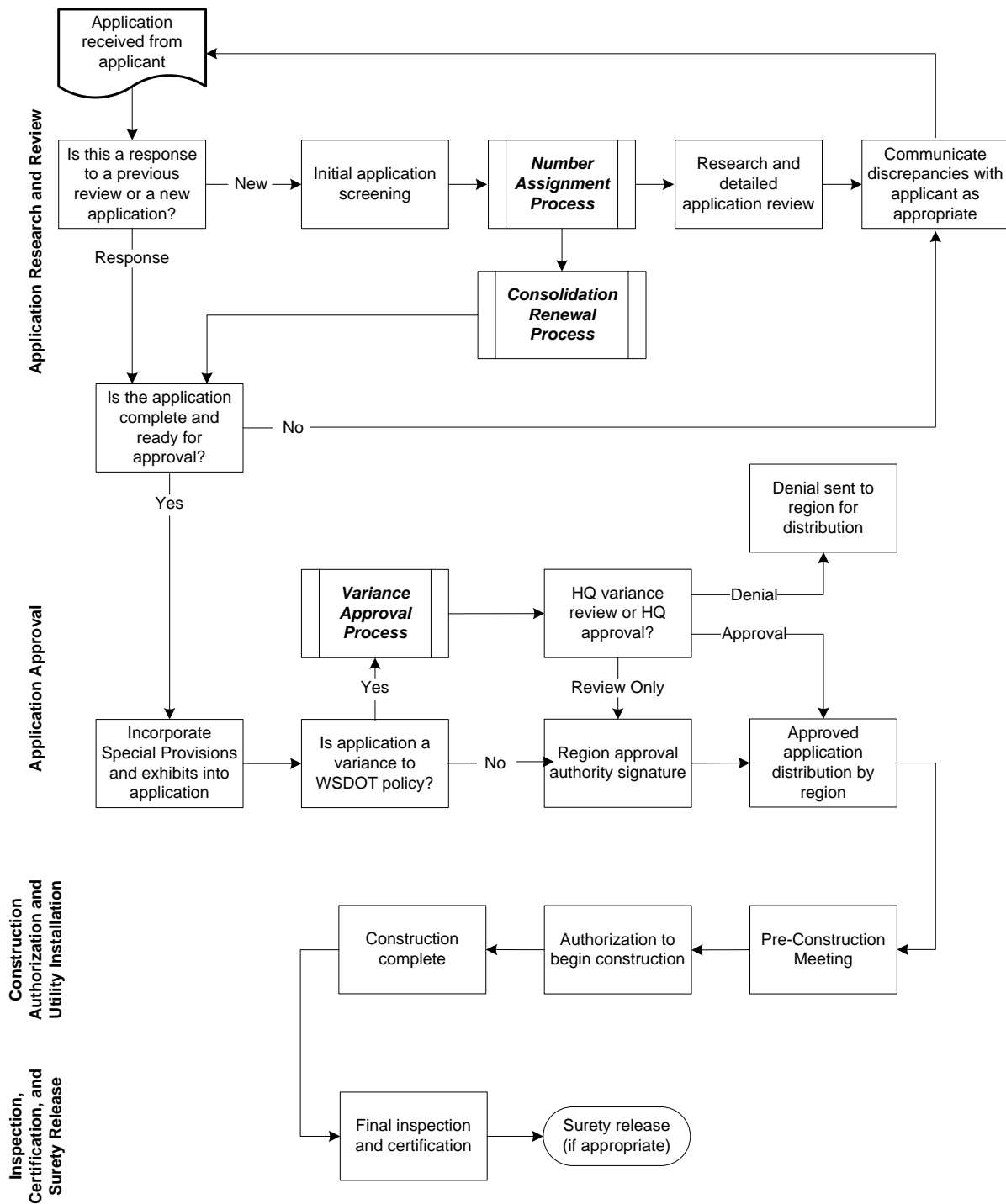

Utility Accommodation Process
Figure 100-8

(1) Application Research and Review

All applications must be reviewed to ensure they are accurate, complete, and meet WSDOT standards and requirements for utility installations within the highway operating right of way.

(a) **Initial Application Screening** – Initial screening should generally include, but is not limited to, the following:

- Application and UFD forms are complete and satisfactory (address, contact information, signature, tax ID number, and so on).
- SR and MP are accurate.
- Installation category is correct.
- Application and UFD information match.
- Attached plans match information on application and UFD.
- Appropriate fee is included with application.
- Does it need a reimbursable account?
- Surety is included or on file (blanket sureties).

(b) **Assigning Application Numbers: Utility Classification Criteria** – Assigning an application number requires that the application be reviewed to determine compliance with the Utility Classification Criteria (see [100.04](#)). Compliance with the Utility Classification Criteria dictates how an application number will be assigned to the application.

The following questions must be answered to determine an application's compliance with the Utility Classification Criteria (see [Figure 100-9](#), Assigning Document Numbers).

1. Does the utility owner have an existing franchise within the boundaries as defined by the Utility Classification Criteria?
 - If no, issue a new utility franchise or permit number as described in [100.02](#), Types of Utility Accommodation Documents.
2. If yes, is the franchise current or expired?
 - If the franchise is current, assign a Franchise Amendment to the proposed utility installation.
 - If the franchise is expired, the Consolidation or Renewal process must be started.

(c) **Consolidations and Renewals** – Consolidations and Renewals are fixed processes that accomplish specific WSDOT utility accommodation goals. Both are required processes if a situation dictates either is necessary (as described previously). Utilities can also enter into the Consolidation process voluntarily. The process is essentially the same, whether it is required by the department or requested by the utility.

The amount of effort for a Consolidation will vary depending on a variety of circumstances. (See [110.02, Franchise Consolidation and Franchise Renewal Process and Requirements](#), for detailed guidance.)

A key goal of the Consolidation process is roadside hazard elimination. Refer to [Chapter 9](#) for a detailed description of the purpose and goals of Control Zone management.

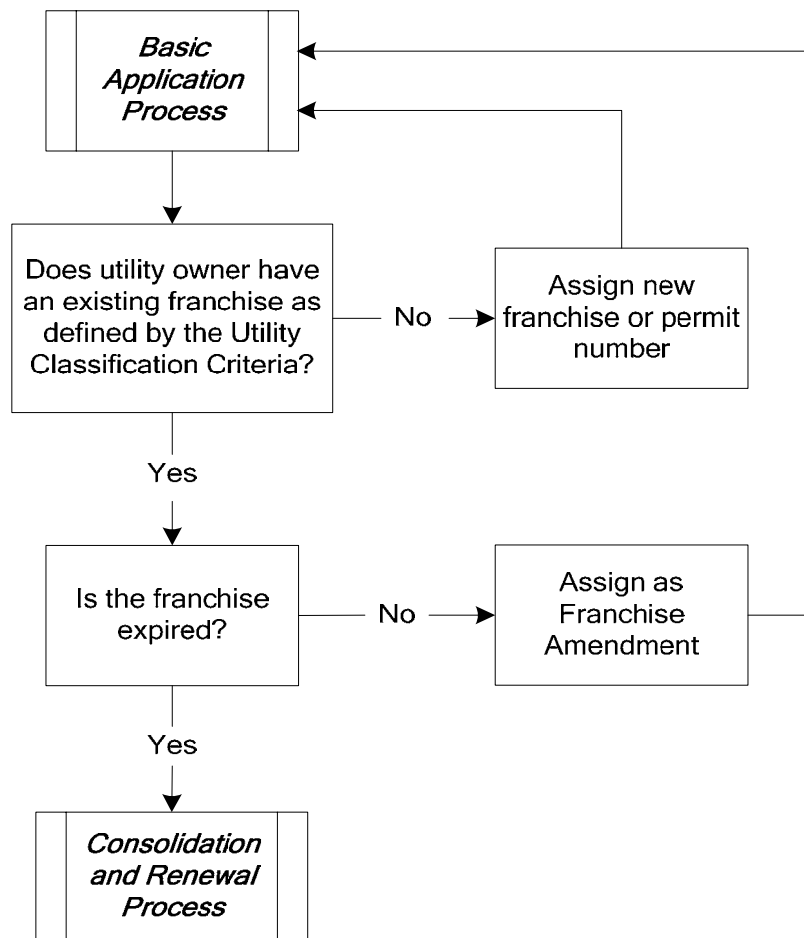

Assigning Document Numbers

Figure 100-9

(d) **Research and Detailed Review** – Once the initial screening is complete and an appropriate application number has been assigned, the application must be reviewed in detail. Depending on the category and complexity of the application, these reviews can be quick and routine. Others may require significant effort from a variety of region functional support offices, including:

- Maintenance
- Bridge Maintenance
- Bridge Preservation
- Traffic
- Environmental
- Landscape
- Hydraulics
- Design
- Project
- Materials Lab

Any variance proposals should also be reviewed at this time to ensure the variance is sufficiently justified, as discussed in [120.14](#), Variances: Types, Treatment, and Approval.

- (e) **Communicate With Applicant** – Once a detailed review has been completed, any identified discrepancies, inconsistencies, errors, unjustified variance proposals, or other issues should be communicated to the applicant. This discrepancy communication process may vary between applications. It can be an informal phone call or e-mail, a formal letter to the applicant, or a scheduled meeting to go over any identified issues in detail. It may also be appropriate to communicate minor issues to the applicant prior to an internal region review.
- (f) **Variances to Policy** – Variance approvals require additional justification and a more rigorous approval process than nonvariance installation proposals. If an application proposes a variance to WSDOT policy, the applicant should be made aware of the type of variance and the associated justification process as soon as possible. Discuss installation alternatives to the proposed variance with the applicant. The utility owner should be provided an opportunity to revise installation location or methods to avoid the variance process and any negative impacts it may have on highway facilities or the utility's construction schedule. (See 120.14, Variances: Types, Treatment, and Approval, for detailed information.)

(2) Application Approval

Prior to approval, all applications should have undergone a comprehensive review process that verifies the application meets WSDOT's utility accommodation policies and guidelines. The final step in the application process is to put together a utility franchise or permit package for approval. Documentation necessary for accommodation documents varies. (See 100.02, Types of Utility Accommodation Documents, for detailed information on accommodation documentation.)

Any approved utility franchise or permit should be detailed and specific enough for a utility inspector or maintenance employee to determine whether a utility contractor is installing the utility as approved.

- (a) **Types of Accommodation Approvals** – Approval of an accommodation application will vary depending on the nature and complexity of the installation proposal. For specific signature approval authorities for various types of utility accommodation documents, refer to 100.06, Approval Authority.
 1. **Nonvariance Approvals** – Applications that meet WSDOT's policies and guidelines are approved within the region by either the Region Utilities Engineer or the Regional Administrator or designee.
 2. **Variance Approvals** – Variance approval is dependent on the type of variance being proposed to determine region, Headquarters, or FHWA approval.

110 General Requirements

110.01 Accommodation Application Requirements

Utility installations shall be authorized only if it can be shown the proposed installation will not have a negative impact upon, nor in any way inhibit, the continued operation, maintenance, structural integrity, or future improvement of highway transportation facilities. In all cases, the needs of WSDOT shall take precedence over the needs of the utility.

(1) Utility Accommodation: Requirements

RCW 47.44
WAC 468-34-160

Utilities must obtain written approval from WSDOT prior to occupation by any materials, equipment, or personnel within the operating highway right of way. The department may grant approval only after appropriate review of the proposed work. Companies installing utilities without WSDOT's express written consent are guilty of a misdemeanor and may be liable for monetary and other penalties, as allowed by law. (See 130.04, Penalties, for additional information on unauthorized utility installations.)

Applications should include sufficient information to allow WSDOT to clearly determine the nature and extent of the utility installation with regard to highway plans and facilities.

WAC 468-34-020(1)

Utilities are required to pay for all costs associated with the review and approval of utility accommodation requests, including related direct and indirect overhead expenses. (See 110.03, Fees and Reimbursable Accounts, for additional guidance on cost recovery.)

(2) Accommodation Documents: Evaluation for Impacts

The purpose of operating right of way is to provide the safe, economic, and efficient transport of people and goods across the state and beyond. Utilities may be installed within the operating right of way provided the installation does not negatively impact these transportation purposes.

Utility accommodation applications received by WSDOT should be evaluated for any impact the installation may have on existing, planned, or potential transportation facilities. To meet the necessary requirements, proposed installations must:

WAC 468-34-130(2)

- Be designed to be safely constructed and maintained.
- Have no adverse effect on the efficient operation of the highway right of way or its facilities.
- Be placed in a location that will avoid interference with highway operations, maintenance, and future highway improvement(s).
- Minimize the need for future utility adjustment to accommodate highway improvements or other transportation work.
- Be placed as near the outside edge of the right of way line as possible for longitudinal installations.
- Not deviate from the *Utilities Accommodation Policy*, WSDOT policy, applicable laws, or industry codes, standards, or regulations.
- Meet or exceed the same legal and regulatory requirements as those required of WSDOT.
- Impart, by law, no monetary cost to the taxpayer or in any way use funds set aside for transportation purposes during the life of the installation.

WAC 468-34-130(1)

WAC 468-34-130(2)

Amendment 18 to
the Washington State
Constitution (Section 40 –
Highway Funds)

(3) Other Documentation: Standard Forms and Exhibits

The following forms and documents (see [Appendix B](#)) are required for all Category 1, 2, and 3 utility installation applications within the operating highway right of way:

- DOT Form 224-030, Special Provisions for Permits and Franchises, Exhibit A
- DOT Form 224-696, [Utility Accommodation Application](#)
- [DOT Form 224-696GP, Utility Accommodation Application General Provision](#)
- DOT Form 224-697, Utility Facility Description, Exhibit B

All applications must be submitted on forms provided by WSDOT. Construction plans and details must show the exact location of the proposed utility in relation to highway features in the vicinity of the proposed installation, including the centerline, fog line, top and bottom of ditch or toe of slope, existing structures, and other highway features.

[WAC 468-34-010\(1\)](#)

(4) Required Documentation: Nonstandard Exhibits

The documents that may also be required with an approved application package, as determined by WSDOT on a case-by-case basis, include:

- WSDOT Right of Way Plan sheet for the installation area.
- Utility-submitted plans, sketches, cross sections, profiles, or details.
- WSDOT installation requirements such as typical crossing details.
- WSDOT-approved Traffic Control Plan.
- Approved Temporary Erosion and Sediment Control (TESC) Plan.
- Approved Dewatering Plan.
- Approved Bridge Attachment Plan and details.
- Consolidation or Renewal Plan.
- Corrective Action Plan.
- Miscellaneous/other plans or details.

[WAC 468-34-010](#)

(5) Required Documentation: Category 4 Applications

Category 4 franchise applications must be submitted to WSDOT with [DOT Form 224-050, Category 4 Utility Authorization, Same-side Service Connection](#) (see [Appendix B](#), Utility Forms and Documents).

[WAC 468-34-110\(53\)\(d\)](#)

(6) Additional Submittal Requirements: All Applications

In addition to category-specific standard and nonstandard form requirements, all applications, regardless of category, require that an appropriate application fee and performance surety be submitted prior to approval of an application. (See [110.03](#), Fees and Reimbursable Accounts, and [110.04](#), Sureties, for detailed guidance.)

[WAC 468-34-020\(1\)](#)
[WAC 468-34-020\(3\)](#)

(7) Utility Installation Plan Requirements

The level of detail necessary for plan submittal is dependent on various factors, including the application category and type of right of way and the circumstances relative to each installation. The following guidelines should be used when considering proposed installation plan requirements.

(a) **Installation Plan Guidelines** – Utility plans should:

- Have sufficient detail to illustrate the intent of the installation.
- Match the Utility Facility Description.
- Clearly define issues such as pavement cuts, horizontal and vertical location, environmental issues, and other data determined necessary by WSDOT.
- Allow utility inspectors to confidently determine whether a utility is installed in the manner and at the location approved by the department.

Plans that do not show sufficient detail to verify factors surrounding a proposed installation may require additional information for WSDOT approval.

110.02 Franchise Consolidation and Franchise Renewal Process and Requirements

Both the Franchise Consolidation and Franchise Renewal processes often require significant research and effort by both the department and the utility for the process to be accomplished thoroughly and correctly. This research should include field verification, review of existing accommodation documents, and other information before a Franchise Consolidation/Renewal can be completed and approved (see [Figure 110-1](#)). This research effort is necessary to: ensure existing surface utilities meet current [Utilities Accommodation Policy](#) standards; verify utility location and ownership; comply with Control Zone requirements; and meet highway safety standards. As much as is reasonable and feasible, all utility information must describe the utility and its appurtenances in their entirety. This is also an opportunity to clean up old files.

Partial Consolidation or Renewal of an existing franchise is discouraged and should be avoided. Franchise Amendments that meet the Utility Classification Criteria do not require Consolidation. Franchise Consolidations and Renewals should include any utilities that have been disconnected/deactivated² on the Utility Facility Description form.

At a minimum, research during the Consolidation/Renewal process should be to review, verify, and correct any issues identified during the process. A Consolidation/ Renewal Plan can be developed at the discretion of each region and in cooperation with the utility for any noncompliant utility objects. This plan shall be attached to the Franchise Renewal or Consolidation document as an exhibit.

(1) Consolidation/Renewal Plan

When necessary, the department should meet with the utility to develop a Consolidation/ Renewal Plan. At a minimum, this plan should outline the:

- Roles and expectations between the utility and WSDOT.
- Time frames and milestones for research and field surveys.
- Deficiencies correction needed.
- Target dates for mitigation and correction.
- Approval of interim service connections.
- Target Consolidation/Renewal submittal date.

As a best practice, the department may provide to the utility any information available regarding known utility locations from internal sources such as hard copy files and databases. Consolidations and Renewals should include disconnected/ deactivated in-place utilities on DOT Form 224-697, Utility Facility Description, Exhibit B (see [Appendix B](#)).

²Disconnected/deactivated utilities must be tracked due to potential impacts to highway improvement projects and for potential use by other utilities or the department.

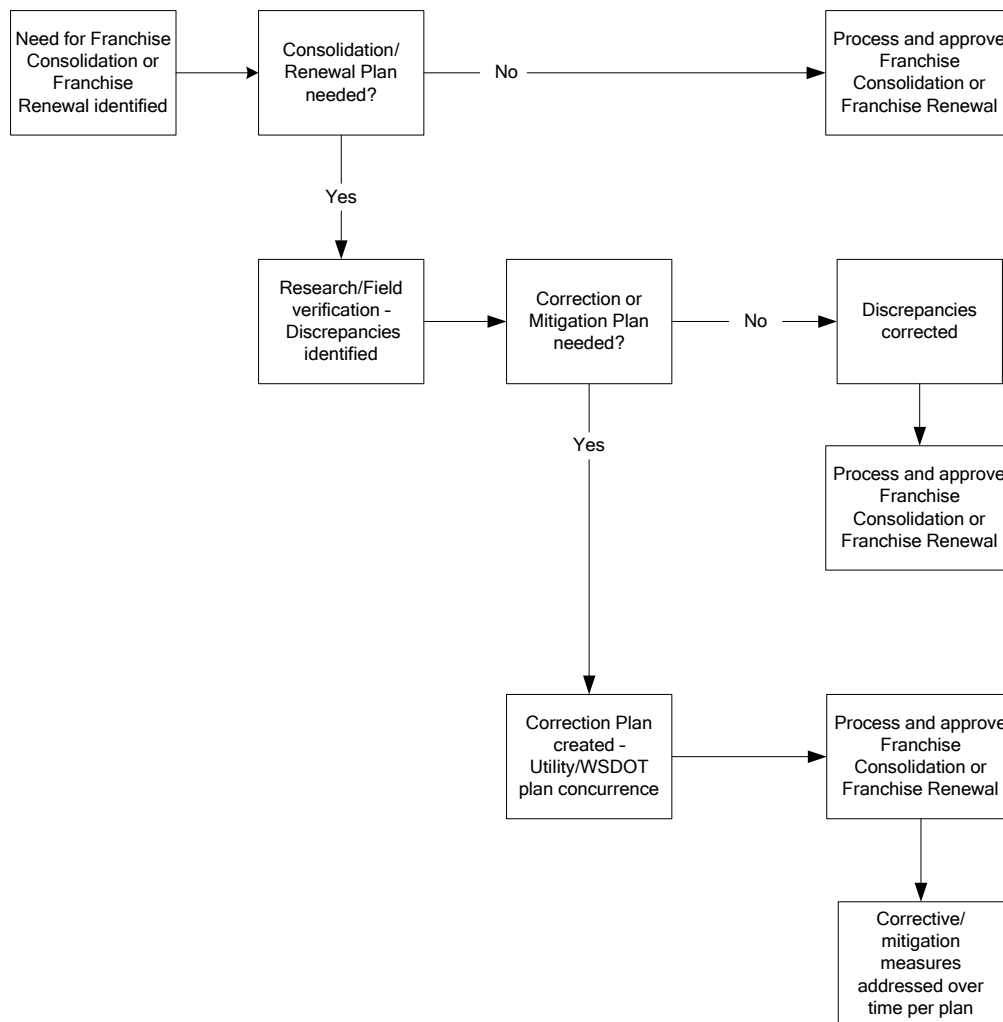

Franchise Consolidation/Renewal Process

Figure 110-1

(2) Research

Franchise Consolidation and Franchise Renewal applications should be reviewed to discover opportunities for utility/WSDOT partnerships for mitigation of deficiencies, as well as to update current conditions. Research information may include the following:

- Utility Classification Criteria
- Planned highway improvement projects
- Planned utility improvement projects
- Annexations
- Access control designation changes
- Category 4 installations
- Undocumented utilities
- New installations being proposed
- Ownership changes
- Traffic safety
- Control Zone
- Scenic Classification

In order to identify deficiencies that may need to be addressed during the Consolidation/Renewal process, it is also necessary to gather field data specific to the method of utility installation in order to accurately verify existing conditions. The following information must be submitted to WSDOT by the utility with the Consolidation or Franchise Renewal application.

- (a) **Field Data: Surface and Aerial Utility Installations** – DOT Form 224-697, Utility Facility Description, Exhibit B, and the Utility Object Relocation Record (UORR) form (see [Appendix B](#)) should be completed and submitted to the department. Both documents should contain the:

- Milepost location of each utility object being described.
- Utility offset from the highway centerline and edge of traveled way (fog line).
- Slope characteristics (such as fill slopes, foreslopes and backslopes, ditch depths and widths, and so on) between the centerline and the utility; extend to right of way whenever possible.

This information should be gathered for any surface and aerial utility objects, including, but not limited to, the following:

- | | |
|---------------------------------------|--|
| • Individual utility and guy poles | • Hydrants |
| • Down guys | • Gas or casing vents |
| • Hydrants | • Conduits, both vacant and occupied |
| • Telephone pedestals | • Other aboveground utilities or appurtenances |
| • Ground-mounted transformers | • Cabinets |
| • Disconnected/deactivated facilities | |

Submit the above-mentioned forms, along with DOT Form 224-696, [Utility Accommodation Application](#) (see [Appendix B](#)), to start the Consolidation or Renewal process.

- (b) **Field Data: Subsurface Utility Installations** – DOT Form 224-697, Utility Facility Description, Exhibit B (see [Appendix B](#)) must be completed and submitted to the department. Utility owners must locate subsurface utilities to verify the location, size, and other attributes of the utility. Information should be gathered for all subsurface utilities, including, but not limited to, the following:

- | | |
|--------------------------|---------------------------------------|
| • Waterlines | • Hand-holds |
| • Valves | • Drainage facilities |
| • Pressure relief valves | • Casings |
| • Blow-offs | • Conduit |
| • Vents | • Vaults |
| • Pumps | • Manholes |
| • Cables | • Disconnected/deactivated facilities |

(3) **Undocumented Utility Installations and Improvements**

Utilities should be encouraged to provide information regarding undocumented utility installations and improvements during the Consolidation/Renewal process. Generally, there should be no penalty or consequence for providing this information. It is to the benefit of both the department and the utility to document as much information as possible about utilities within the operating highway right of way.³ Approach the Consolidation/Renewal process as an opportunity to collaborate with the utility to locate and identify as many undocumented utilities as possible.

- (a) **Planned Highway Improvements** – The department should inform utilities early and often of any planned or programmed highway improvements that may offer an opportunity for correction of identified utility deficiencies or improvements. Frequent communication with the utility industry by region Utilities Offices is strongly encouraged.

³ Accurately documenting utilities avoids utility damage during highway maintenance work and costly impacts to highway improvement projects due to delays caused by unidentified utilities.

- (b) **Planned Utility Improvements** – Utilities should be encouraged to share planned improvements with WSDOT that may offer opportunities to enhance the safety and visual quality of highway corridors.
- (c) **Annexations** – Franchise Consolidations and Franchise Renewals should exclude those portions of the previous franchises and permits now located within city limits. The current State Highway Log should be reviewed for changes in the milepost limits of city boundaries. Local agencies should also be contacted to determine recent annexations that may not be included in the current State Highway Log. Limited access highways are exempt from this rule. (See 120.03, Annexations and Route Jurisdiction Transfers, for additional guidance.)

 Best Practice

To avoid confusion and to maintain a historical record of changes between successive accommodation documents, changes in jurisdiction should be noted in the accommodation document.

 Best Practice

- (d) **Access Control Designation Changes** – Right of way designations should be reviewed for changes in access levels. Generally, this only affects jurisdiction issues relating to utilities located within city limits (see [Annexations](#) above). WSDOT retains jurisdiction and control of utilities installed within limited access right of way.

If a local agency has annexed an area of the highway since the last franchise was issued, but part or all of this area is within limited access, this condition should be noted in the Special Provisions.

- (e) **Scenic Classification** – Aboveground utilities should be reviewed for changes in scenic classification designations as well as the need for existing utilities to be installed underground within Scenic Class A or B or areas designated as Subclass X.
- (f) **Safety** – As part of the Consolidation/Renewal process, research should be conducted to determine the location of any highway safety issues, such as documented utility pole hits, clear zone inventories, and other data, to identify any known or potential deficiencies along a highway corridor. Provide this information to the utility company and compare with data provided by the utility to assist in developing a Mitigation or Corrective Action Plan. Corrective measures should be created in partnership with the utility to remove or mitigate the unsafe utility object and protect the traveling public. The plan should identify what measures will be taken to resolve the safety issues as well as the agreed time frame for making improvements.

Safety issues that may need to be addressed when considering Consolidation/ Renewal efforts include:

- Areas with potential for improvement.
- Facilities within the Control Zone.
- Highway and utility maintenance issues.
- Highway improvement or preservation projects.
- Utility improvement projects.

The Consolidation/Renewal process should include review of utility-related accidents within the area of the proposed Consolidation or Renewal. Obtain an accident report from the region Traffic Safety Office (TSO) for the highway and milepost limits of the Consolidation/Renewal under consideration. Areas with potential for improvement identified by the TSO that involve utilities should be mitigated or, preferably, corrected by the utility as soon as possible, with high priority.

- (g) **Highway Maintenance** – Consult local highway maintenance areas to identify any utility installations that may be troublesome for highway maintenance crews. Include corrections to issues identified in the Corrective Action Plan.
- (h) **Corrective Action Plan** – When significant discrepancies are identified whose correction may place a significant financial or operational burden upon a utility, a Corrective Action Plan or Mitigation Plan should be created jointly between WSDOT and the utility. Both the utility owner and the department should approach the Consolidation/Renewal process in a cooperative manner in order to develop a plan for addressing any deficiencies identified during the Consolidation/Renewal process.

When deficiencies are identified, WSDOT should work cooperatively with the utility to develop a Corrective Action Plan. This plan should outline the:

- Expectations of the utility.
- Constraints limiting immediate deficiency correction.
- Plan for overcoming identified constraints.
- Time frames and milestones for correction of specific deficiencies.
- Target completion date.

Once deficiencies have been identified, both organizations should work together to develop a workable plan to mitigate deficiency issues. Corrective Action Plans should identify and prioritize the correction of deficiencies. For example, documented safety issues such as utility pole hits should be a top priority, and a plan for immediate correction should be developed. Identified clear zone infractions without a documented history of accidents may be corrected systematically over time as part of planned highway improvement project utility relocation efforts or during planned utility upgrades.

Regardless of the manner in which deficiencies are addressed, it is important to take proactive, systematic, and cooperative steps toward making corrections. Creation of a Corrective Action Plan holds the utility responsible and accountable, identifies reasons for delay of immediate corrective actions, and creates expectations of the utility.

When used, Corrective Action Plans should be attached to the Franchise Consolidation/Renewal application as an exhibit.

(4) New Utility Installations Included in Consolidations/Renewals

New utility installations may be included in Consolidations or Renewals. However, the Consolidation or Renewal process is mainly an inventory and administrative procedure and does not provide the same level of review and approval as a new utility installation. Issues related to new utility construction, such as traffic control, construction impacts to highway facilities and maintenance, and related issues need to be addressed when new utility installations are proposed to be included as part of the Consolidation/Renewal document.

Circumstances vary with each situation. However, it may be better to process an amendment separately from the Consolidation/Renewal being developed, rather than issue the amendment at the same time as the Consolidation/Renewal document.

(5) Consolidation/Renewal Administration

Administratively, Consolidations and Renewals provide opportunities to clean up old files.

For Consolidations, use the Utility Classification Criteria to combine franchises, amendments, permits, and Category 4 permits into a new document. Assign a new franchise number and cross reference the old documents into the new document both in

the Special Provisions and the Utility Franchise and Permit (UFP) database. Document retention rules require that documents superseded by the Consolidation be kept in the region Utilities Office for six years, after which they should be destroyed.

A Franchise Renewal is used to cover facilities that were issued under a franchise that was at, or near, its expiration date. The Renewal should include all amendments to the initial franchise. Permits, Category 4 facilities, and unrecorded facilities may be included in the Franchise Renewal if they are within the limits of the initial franchise and its amendments. Facilities covered by other franchises cannot be included in the Franchise Renewal.

(6) Utility Responsibility

By signing the Utility Accommodation Application, the applicant agrees to meet the terms and conditions of the application and any exhibits or attachments issued with the approved application. Those requirements include maintaining a valid and active utility accommodation document. Although WSDOT may inform a utility of expired utility franchises, it is ultimately the responsibility of the utility to ensure it has sufficient resources to meet the requirements contained herein.

WSDOT acknowledges this may require resource expenditures by utilities in order to meet this obligation. It is the department's expectation that, by allowing utilities to occupy the operating highway right of way, all requirements of the *Utilities Accommodation Policy* will be met, including maintaining an active accommodation document, and that the utility will plan for such contingencies accordingly.

By signing a utility accommodation document, the utility agrees to meet its obligations to WSDOT in a timely and satisfactory manner.

- (a) **Delay by Utility** – Upon notification by WSDOT of an expired or soon-to-expire utility franchise, it is expected that the utility will make a reasonable and timely effort to obtain a utility accommodation document that meets the requirements of the Utility Classification Criteria. If a utility fails to reasonably meet this obligation, notification should be given to the State Utilities Engineer.

Upon review, the State Utilities Engineer may take action up to and including placing a regional or statewide moratorium on further approval of accommodation documents submitted by the utility until such time as the utility is in full compliance with the state Utilities Accommodation Policies.

WAC 468-34-100

110.03 Fees and Reimbursable Accounts

This section describes accommodation documents' fees and reimbursable charges for WSDOT expenses in dealing with utilities' requests for installations within WSDOT right of way.

(1) Accommodation Fee Expenses

Fees collected cover the basic overhead charges related to the processing of accommodation applications. This work includes, but is not limited to, administrative services such as photo copying, accounting, and release of individual sureties. Fees also include work associated with receiving and reviewing applications for overall completeness and minor revisions to the application needed to meet WSDOT submittal requirements.

WAC 468-34-020(1)

(2) Accommodation Fees

WAC 468-34-020(1)

Accommodation fees for various types of applications or processes are shown in [Figure 110-2](#).

Application/Process	Fee
Category 1 Installation	\$500
Category 2 Installation	\$300
Category 3 Installation	\$150
Category 4 Installation	No Charge
Franchise Consolidation	\$300
Franchise Renewal	\$250
Transfer of Ownership	\$50

Fee Schedule

Figure 110-2

(3) Reimbursable Charges

WAC 468-34-020(2)

Reimbursable engineering costs beyond the application fee will be charged for:

- Both internal and external meetings related to the proposed utility installation.
- Detailed engineering review of accommodation requests such as clear zone calculations; scenic classification; Utility Facility Description (UFD) and installation plan review; Variance Justification review; diary entries and internal correspondence (written as needed for application approval).
- Preapplication approval field review by WSDOT personnel as necessary.
- Review of utility relocation plans related to highway improvement project utility relocation needs, to ensure compliance with the [Utilities Accommodation Policy](#).

Reimbursable costs will also be charged for postapplication approval field inspection necessary to ensure utility facilities are installed as reviewed and approved by WSDOT. (See [Chapter 7](#), Inspection, for additional details.) Costs for inspection may include, but are not limited to:

- Preconstruction meetings.
- Construction inspection to verify it is installed according to the accommodation document.
- Travel time to and from worksite.
- Oversight of traffic control.

WAC 468-34-020(2)

(4) Reimbursable Accounts

Regions should establish a single dedicated “J” Account for each utility customer. Subsequent accommodation applications should be assigned a separate Group number under the utility’s “J” Account that references the proposed installation’s:

- Application number.
- Milepost limits.
- State route number.
- Utility Work Order number (if available).

For further guidance on reimbursable accounts, see [Chapter 8](#), Reimbursement.

(5) Accountability

It is WSDOT's policy that signature by the utility on the Utility Accommodation Application, authorizes the department to charge for all costs associated with processing the utility's application. Language on the application states that the customer agrees to this policy by signature.

When WSDOT experiences difficulties recovering costs from a utility, the utility may be subject to more stringent recovery policies. Consult with region accounting personnel or the State Utilities Engineer if cost recovery becomes an issue with a particular utility.

110.04 Sureties

Sureties provide WSDOT with a means of recovering costs in the event the utility does not meet its obligations of the General and Special Provisions of the Utility Accommodation Application. They insure completion of construction, including the restoration of surfacing, slopes, slope treatment, top soil, landscape treatment, drainage facilities and cleanup of right of way. If the Utility does not have a blanket bond on file an individual surety, consistent with WAC 468-34-020 (3), should be considered for facility maintenance if ground disturbing activities occur.

WAC 468-34-020(3)

(1) Surety Classes

There are two Surety Classes used in conjunction with utility installations within the highway operating right of way.

- (a) **Individual Surety** – An individual surety is a one-time surety attached to a single utility installation project. The surety is released upon satisfactory completion of that utility installation. For additional guidance, see [Surety Release](#) (below).
- (b) **Blanket Surety** – A blanket surety is acceptable for multiple utility installations by a single utility owner and is valid throughout the state of Washington as long as the surety remains in effect. Depending upon the circumstances of a specific utility installation project, a blanket surety may be supplemented by an individual surety if deemed necessary by WSDOT.

(2) Types of Sureties

There are three types of sureties that can be used within each Surety Class. Utilities have the option to choose which surety to use, provided they are eligible to use the surety type.

(a) Individual Surety

1. **Individual Bond** – An Individual Class surety obtained from a licensed bonding agent. Use DOT Form 224-048, Individual Bond for Franchise or Permit (see [Appendix B](#)).
2. **Individual Escrow Agreement (see Appendix B)** – An Individual Class surety obtained from a licensed banking institution, which must be notarized.
3. **Individual Governmental Entity Pool** – An Individual Class surety obtained from an approved entity pool program.

(b) Blanket Surety

1. **Blanket Bond** – A Blanket Class surety obtained from a licensed bonding agent. Use DOT Form 224-012, Blanket Bond for Franchises and Permits (see [Appendix B](#)).

2. **Blanket Escrow Agreement** – A Blanket Class surety obtained from a licensed banking institution, which must be notarized.
3. **Blanket Governmental Entity Pool** – A Blanket Class surety obtained from an approved entity pool program.

WSDOT recognizes that surety bonding may be difficult for some smaller local agencies. Recommend Assignment of Escrow Accounts to smaller agencies with limited resources. Escrow accounts have no cost and they gain interest while held in the bank.

WSDOT should also work closely with local agencies to ensure understanding of surety requirements and how those requirements could affect agency construction schedules. Local agencies should also be made aware of the department's bonding release requirements. If the local agency releases its contractor's bond before WSDOT inspects and releases the local agency's surety with the department, the agency will be liable for repairs to the highway if the contractor's work is substandard and requires attention.

(3) Governmental Entity Pools

A Governmental Entity Pool is an alternative surety for local agencies and public utilities. For-profit utilities are not eligible for Entity Pool coverage.

Generally, an Entity Pool only provides liability coverage for Participating Members' third-party damages, such as bodily injury or property damage, resulting from members' negligent acts. Coverage is not normally provided for performance. In order for a utility to use an Entity Pool as a surety for highway utility installation purposes, the Entity Pool must be willing to provide, by Resolution, performance coverage in lieu of a performance bond on behalf of its Participating Members.

- (a) **Entity Pool Eligibility** – To meet WSDOT's entity pool surety requirements, an organization must:
 - Be a local agency, such as a city or county, or a public utility.
 - Be a participating member in a joint self-insured local government property/liability program.
 - Have the approval and oversight of the State Risk Manager in the Office of Financial Management (OFM), as provided in [RCW 48.62](#).
 - Operate under the rules of [WAC 82-60](#).
 - Be listed on the OFM Risk Management Division Local Government Self-Insurance Program.

(4) Sureties for Other State Agencies

Sureties are not required for utility accommodations involving other state agencies.

(5) Sureties for U.S. Government Agencies

Sureties are not required for federal agency utility accommodations.

(6) Surety Requirements

The following are minimum requirements for all sureties submitted:

- Must be an original surety document.
- Escrow Agreement must be from a legally licensed banking institution.
- Escrow Agreement must be stamped, signed, and notarized by a valid Notary Public licensed to do business in the state of Washington.

- Bonds must be issued from a bonding agent licensed within the state of Washington. State forms may be used by the bonding agent, or bonding agents may use their own forms, provided all information contained on the state form is contained in the agent form.
- Entity Pool sureties must be self-insured local government property/liability programs that have the approval and oversight of the State Risk Manager in the Office of Financial Management as provided in [RCW 48.62](#) and operate under the rules of [WAC 82-60](#).

(7) Surety Acceptance

The Region Utilities Engineer approves and maintains individual sureties. The HQ Utilities, Railroad, and Agreements Manager approves and maintains blanket sureties. HQ Utilities also maintains a Holder List of approved blanket sureties that is updated and published regularly.

When the bond document is delivered to the Headquarters or Region office the bond needs to be processed. These steps include:

- Check Office of the Insurance Commissioners' website to ensure that the Insurance Company is licensed to do business in the State of Washington.
<https://www.insurance.wa.gov/consumertoolkit/search.aspx>
- Once confirmed the signatory signs the bond as acceptable to the State. Return a copy of the signed acceptance to the Insurance Company and the bond holder (Principle) for their files.

Be sure the individual bond acceptance has been filled out with the Region contact information- this is important to ensure that if the insured is cancelling or replacing a bond the Department is notified in a timely manner and the cancellation can be approved or the holder and the insurance company can be advised that it cannot be released.

- The original should be filed either in the Franchise or permit it is applied to or a bond file

HQ: Enter into the Bond Holder Database and provide and updated report for the regions.

(8) Surety Amounts

- Individual Surety Minimum Amounts** – Individual bonds and Assignment of Escrow Accounts shall be a minimum of \$1000. Surety amounts may be higher if deemed necessary or prudent by WSDOT to enable recovery of foreseeable expenses. [WAC 468-34-020\(3\)](#)
- Blanket Surety Minimum Amounts** – Blanket Bonds shall be a minimum of \$10,000. However, an individual surety may be used to supplement a blanket surety on a case-by-case basis for individual utility installations if deemed necessary or prudent by WSDOT. [WAC 468-34-020\(3\)](#)
- Additional Surety** – The Region Utilities Engineer should use individual discretion when considering requiring increased or additional surety amounts beyond the minimum. Reasons or conditions for requiring increased amounts include, but are not limited to:
 - Open cuts of the paved roadway.
 - Other Category 1 installations.
 - Demonstrated poor work performance issues.
 - Scope of work, such as large or high-impact projects.

- Roadway crossings other than open cuts.
- Bridge attachment installations.

WSDOT may increase surety amounts for any reasonable situation deemed high risk to the continued safety or operation of department facilities.

(9) Surety Duration

To ensure authorized utility work has been done to WSDOT's satisfaction, all sureties remain in effect until Completion of Construction, as follows:

WAC 468-34-020(3)

(a) **Installations Outside the Roadway** – Sureties for work outside the roadway prism shall be maintained for a minimum period of one year after the date of completion of construction. Drainage, reestablishment of vegetation, or other issues may extend this time period on a case-by-case basis (see below).

WAC 468-34-020(3)

(b) **Open Cuts of Traveled Lanes or Shoulders** – Sureties for work involving disturbance of the roadway prism shall be maintained for a minimum period of two years after the date of Completion of Construction. This is to ensure no settling or other secondary damage has occurred as a result of the installation.

WAC 468-34-020(3)

(c) **Drainage, Vegetation Reestablishment, or Other Special Situations** – Sureties for special situations shall be held as needed for the situation until Completion of Construction. For example, sureties for utility work requiring revegetation may be held until revegetation has taken hold to WSDOT's satisfaction. Specific conditions and expectations defining when a surety may be released should be clearly identified in the accommodation document provisions. Identify contact persons in Special Provision No. 1, when used.

(10) Surety Release

- (a) **Individual Sureties** – The surety holder or surety agent must request a surety release in writing from WSDOT. Upon satisfactory review, a letter authorizing the release of the surety must be sent to the bonding agent or banking institution where the surety is held. A copy of the letter should also be sent to the surety holder.
- (b) **Blanket Sureties** – Requests for release of blanket sureties must be made in writing to the State Utilities Engineer. A Notice of Request for Release of Blanket Surety must be distributed to each Region Utilities Engineer for review of installations within their regions. All utility installations installed by the Surety Holder must be reviewed to ensure the Surety Duration has been satisfied.

(11) Changing Blanket Surety

Unless authorized by WSDOT, utilities making a change in surety agents are required to maintain a surety at all times during the surety transition.

110.05 Local, State, or Federal Agencies

All utility installations proposed within the operating highway right of way require submittal of an Utility Accommodation Application, including all local, state, or federal agencies.

(1) State and Local Agencies

Some state and local agencies from which WSDOT may receive utility accommodation applications include, but are not limited to, the following:

- City municipalities
- County governments
- Department of Natural Resources (DNR)
- Department of Fish and Wildlife (DFW)
- Public school districts
- State Parks and Recreation Commission
- State-funded colleges and universities

Submit applications for utility installation proposals from local agencies and other state agencies on DOT Form 224-696, Utility Accommodation Application (see [Appendix B](#)). These applications are subject to the same requirements as other applications. Additional documentation may be required as defined elsewhere in this manual or as determined by the Region Utilities Engineer.

(2) Coordination With Other State Agencies

Some state agencies have Memorandums of Understanding (MOUs) with WSDOT. These MOUs may specify that the department and the state agency work together in a certain manner or may outline specific expectations regarding utility accommodation. Currently WSDOT has established MOUs with the following state agency:

- (a) **Department of Natural Resources (DNR)** – WSDOT utility franchises authorize utility companies to install utility facilities within state right of way, but do not authorize utility companies to occupy DNR-managed aquatic lands. DNR also owns and manages upland areas where WSDOT occupies right of way by easement for roadway purposes only.

The DNR maintains authority for management of the state's aquatic lands and issues proprietary easements for activities that occur on them,⁴ including utility easements. In addition to obtaining a utility franchise or permit from WSDOT, utility companies whose facilities are installed upon WSDOT rights of way or highway facilities that cross over DNR-managed aquatic lands and upland ownership must also obtain an easement from DNR.

⁴ These include tidelands and bedlands in the Puget Sound, Willapa Bay, and Grays Harbor; bedlands along the outer coastal shelf; and shorelands and bedlands within navigable freshwater lakes and rivers throughout the state.

(3) Federal Agencies

WSDOT has standing agreements with the following two federal agencies that obligate the department to specific rights, obligations, and coordination efforts relative to utility installations or relocations on state highways.

Agency	Agreement
U.S. Bureau of Reclamation (USBR)	GC-1020-B
U.S. Department of Agriculture, Forest Service	NFS 00-MU-11060000-040 (MOU)

Other federal agencies that may submit utility accommodation applications to WSDOT include, but are not limited to, the following:

- Department of Homeland Security
- Bonneville Power Administration (BPA)
- U.S. Army Corps of Engineers (Corps)
- NOAA USGS
- U.S. Fish and Wildlife Service
- U.S. Department of Energy

Utility installation proposals received from federal agencies must be processed using DOT Form 224-699, Application for Utility Permit or Franchise for U.S. Government Agencies (see [Appendix B](#)). This form contains General Provisions that differ from those of other utilities. Verify that the correct General Provisions are attached to the application prior to issuing the approved document. Use necessary Special Provisions the same as any utility installation application.

Refer to [Chapter 5](#), Government Agencies: State, Federal, Tribal, and Other Entities, for additional information regarding coordination and requirements relating to specific federal agencies.

[WAC 468-34-020\(1\)](#)

- (a) **Federal Agency Fees** – Applications received from the federal government are exempt from application fees. However, the region may still require the federal agency to pay for any additional costs incurred by WSDOT for the review and approval of the agency's accommodation application. Other than application fees, all other application requirements apply to federal applications.

(4) Utility Installation Application Requirements

All utility installations within the operating highway right of way, including those from other government agencies, require submittal of the appropriate accommodation application for review and approval by WSDOT prior to occupation of construction personnel, equipment, or materials on the highway right of way or installation of the utility. Refer to [110.01](#), Accommodation Application Requirements, for detailed submittal requirements.

120 Specific Installation Requirements

120.01 Hearings

(1) *Determining the Need for a Franchise Hearing*

WSDOT is required to determine whether an opportunity for public hearing is necessary for certain utility installations. When determining the need, factors such as traffic flow, residential and public use area access, and business and environmental impacts should be considered.

RCW 47.44.010
RCW 47.44.020
WAC 468-34-030(1)

Hearing opportunities will normally be required for proposed utility installations that involve:

WAC 468-34-030(2)

- Overhead transmission lines in excess of 35 Kv.
- Facilities involving the installation of carrier pipe larger than 18 inches nominal diameter.
- Facilities requiring an excavation wider than 3 feet.
- Pipelines carrying transmittants that are flammable, corrosive, expansive, energized, or unstable and that are larger than 4 inches nominal diameter.
- Pressurized carrier pipes larger than 12 inches nominal diameter.
- Underground installations of any size that require excavation through landscaped areas authorized by permit and that are maintained by owners of abutting property.

WSDOT may approve, without advertisement, all other franchise applications.

(2) *Hearing Requirements Met Under a Related Process*

WSDOT may determine that hearing requirements have been met if the planned facility has already been or will be the subject of environmental land use or other hearings, such as the SEPA process or where the applicant presents evidence of a direct contact with owners of abutting property. However, any comments received from the public Notice of Opportunity for a Hearing must be addressed to the satisfaction of the department by the applicant prior to approval of the franchise.

WAC 468-34-030(3)

(3) *Franchise Hearings*

Those franchise applications that WSDOT determines warrant a hearing or hearing opportunity shall be processed in accordance with [WAC 468-34-040 – 468-34-090](#).

120.02 City Streets as Part of State Highways

A city is responsible for utility permitting on non-limited access highways within its city's limits. WSDOT is responsible for maintaining the pavement on the highway within the city limits. Even though cities can allow open cuts of the highway, the restoration must meet department requirements. All efforts should be made by the region Utilities Office to coordinate review of any proposed utility installation within the city.

RCW 47.24.020(4)(5)

Work Zone Traffic Control for utility installations must meet MUTCD requirements. The region must work closely with the city to ensure the use of proper Work Zone Traffic Control.

RCW 47.24
RCW 47.24.020(13)

120.03 Annexations and Route Jurisdiction Transfers

(1) Annexations

Cities often annex areas along or near existing city boundaries that include state highways. This annexation process effects jurisdiction as it relates to utility accommodation. (See [120.02](#), City Streets as Part of State Highways, for information on jurisdictional issues relating to utility accommodation.) Annexations that include non-limited access highways transfer jurisdiction of utility permitting authority to the city. City limits are noted on the latest edition of the State Highway Log. Annexation information is the responsibility of the local cities and counties.

- (a) **Processing Existing Accommodation Documents** – Existing accommodation documents approved by WSDOT should be sent to the local agency. Entries should be made in the UFP and the accommodation document file indicating the date of transfer and other pertinent data such as local agency contact information and annexation resolution number. A letter or other assignment document must be sent to the local agency indicating the assignment of the utility accommodation authority.

(2) Route Jurisdiction Transfers

[RCW 47.24.020](#)

Route Jurisdiction Transfers (RJTs) are the transfer of ownership of a specific roadway from WSDOT to a local agency or vice versa. Upon formal transfer, operation and maintenance responsibilities are transferred to the receiving agency.

- (a) **Transfer to WSDOT by a Local Agency** – When WSDOT accepts responsibility for a roadway, every effort should be made to obtain all available utility accommodation information from the local agency. Any companies known or suspected of having utilities along the route should also be contacted and informed of the change in route ownership. Existing accommodation documents obtained from the local agency are automatically canceled. All utilities must obtain an approved accommodation document from the department. Refer to [Undocumented Utilities](#) (below) for information on obtaining an accommodation document for existing utilities.

Other considerations include:

- City limits and jurisdiction issues
- Access control levels
- Control Zone issues
- Property rights (easements)
- Urban growth and associated utility issues

1. **Ownership Transfer to WSDOT: Acceptance Process** – The region Utilities Office should make every effort to become involved as early as possible in the transfer process to ensure utility accommodation issues are properly coordinated. Routes being transferred to WSDOT should be screened to estimate the level of effort needed by the region Utilities Office to bring the proposed route up to department standards before the transfer process is completed and to inventory obvious utilities. Make every effort to obtain existing accommodation documents from the local agency and incorporate them into WSDOT records.

Review existing permits or franchises issued by the local agency for contract terms. If there is a termination clause, WSDOT should decide whether to terminate the agreement pursuant to the termination language and issue its own franchise or maintain the existing agreement. If no termination clause exists, regions should contact [HQ Utilities](#) for legal assistance if necessary.

2. **Reviewing Existing Accommodation Documents** – After obtaining existing accommodation documents from the local agency, they should be reviewed for language that may bind WSDOT or the utility to specific actions or conditions.
 3. **Processing Existing Accommodation Documents** – New franchises or permits must be issued using standard WSDOT forms and provisions. Copies of existing documents received from the local agency should be kept in the file until a new WSDOT-issued accommodation document is issued. Copies of the new franchises shall be sent to the utility owner.
 4. **Resolving Existing Safety and Variance Issues** – Existing accommodation agreements between the local agency and the utility cannot be contrary to WSDOT utilities accommodation policies. Resolution of issues such as Control Zone encroachments relating to existing aboveground utilities should be approached in a programmed manner that accounts for budgetary and other constraints associated with the utility owner. At the same time, it should provide a method of resolving safety or other issues on the newly acquired roadway in a timely fashion.
 5. **Undocumented Utilities** – Undocumented utilities are often identified when a service connection or extension of an existing utility is needed on an RJT highway. Undocumented utilities should be provided a reasonable opportunity to become properly documented with WSDOT. Every effort should be made to work cooperatively with the utility to document the existing utility infrastructure while subsequently accommodating the installation of the newly proposed utility facility. (See [130.07](#), Undocumented Utility Installations, for detailed guidance.) Treat unsafe conditions such as utilities within the Control Zone with a Corrective Action Plan (see [Chapter 9](#)).
- (b) **Transfer from WSDOT to a Local Agency** – When a route is transferred to a local agency, existing accommodation documents must be part of the transfer. Existing accommodation documents held by WSDOT are canceled. Original accommodation documents identifying existing utilities must be sent to the local agency. Entries are to be made in the UFP revising the status of transferred documents to Inactive. Entries should explain where the documents were transferred, the date of the transfer, and the resolution or certification number.
1. **Processing Existing Accommodation Documents** – Existing accommodation documents approved by WSDOT should be forwarded to the receiving agency. Entries should be made in the UFP indicating the date of transfer and other pertinent data such as local agency contact information.

[RCW 35A.14.900](#)

(3) Fees

All costs associated with processing accommodation documents that resolve existing safety or variance issues are to be paid by the utility as defined in [Chapter 8](#), Reimbursement. Existing but undocumented utilities are subject to all fees and costs associated with documentation of the existing utility. (See [130.07](#), Undocumented Utility Installations, for additional guidance.)

[WAC 468-34-020](#)

120.04 Pipelines

Pipelines and casing installed within the operating right of way must meet the requirements of this manual, the WSDOT [Utilities Accommodation Policy](#), and the references. References to pipe in this section are inclusive of all types of pipe, including carrier pipe, casing, galleries, conduit, innerduct, or any other enclosure that may convey or contain a utility.

(1) *New Installations*

WAC 468-34-240(1)

Applications for proposed pipeline installations must specify:

- Capacity, count, class of transmittants, or other quantitative data.
- Maximum working, test, and/or design pressures.
- Industry design standards for the class of carrier.

(2) *Changes in Existing Facilities*

WAC 468-34-240(2)

Pipeline use is restricted to that which was originally approved. Changes in the use of an existing pipeline require advance approval by WSDOT. A new application could be required for any change in the originally approved facility, which may include:

WAC 468-34-240(1)

- Ownership (see [130.05](#), Utility Transfer of Ownership – Acceptance of Assignment).
- Capacity, count, class of transmittants, or other quantitative data.
- Increase or decrease in maximum working, test, and/or design pressures.
- Change in capacity.

Any changes made to previously approved installations should be documented appropriately.

(3) *Abandoned, Deactivated, or Disconnected Pipeline*

WAC 468-34-250(3)(d)

When it is determined a pipeline is no longer needed, the first consideration should be removal. If removal is determined to be infeasible, an abandoned pipeline may remain within the operating highway right of way provided doing so would not negatively affect the roadway structure or continued maintenance and operation of the highway facility. Abandoned pipe shall be backfilled with pressure grout or other suitable material as directed by WSDOT. (See [130.06](#), Abandoned, Deactivated, or Disconnected Utilities, for additional guidance.)

Best Practice

- (a) **Documentation of Abandoned, Deactivated, or Disconnected Pipelines** – To aid project design and delivery efforts within WSDOT, an accommodation document should be maintained on file for the abandoned in-place pipe defining the status, location, and ownership of the abandoned pipe.

Best Practice

- (b) **Hazardous Piping Material** – Ownership of any abandoned, deactivated, or disconnected pipelines composed of hazardous materials such as asbestos cement should remain the property of the utility until such time as the pipe is removed from the right of way and properly disposed of. Maintain an accommodation document for the utility and list the pipe as abandoned in the UFP database.

Best Practice

- (c) **Pipes Carrying Hazardous Material** – Abandoned, deactivated, or disconnected pipelines that may have transmitted hazardous substances such as petroleum or other products can remain in the right of way as long as the pipe has been flushed or otherwise decontaminated. The abandoned utility may be used for a subsurface conduit or casing if a future need arises in the area.

(4) Existing Pipelines: Adjustment

Adjustment of pipe location, depth, size, or capacity is often necessary due to utility needs, construction conflicts, existing shallow installation depth, damage, or other situations and/or conditions. When adjustment becomes necessary, all governmental and regulatory codes, industry standards and specifications, and WSDOT requirements shall be met. A new application is required for any change in the facility that was originally approved.

In general, utility installations and adjustments are to be made with due consideration to highway and utility costs and in a manner that will provide maximum safety to the highway users; will cause the least possible interference with the highway facility and its operation; and will not increase the difficulty or cost of maintenance of the highway.

Where highway construction or alterations are considered, utility companies should be involved early in the design process. This will permit joint and parallel activities to be coordinated throughout the life of the highway project. Where utilities exist within the right of way of a highway to be widened or improved and a utility relocation is likely, consideration should be given to again accommodate those existing utilities within the highway right of way.

WAC 468-34-260

See AASHTO's "A Policy on the Accommodation of Utilities Within Freeway Right-of-Way"

(5) Pipelines in Existence Prior to Highway Construction or Designation

Carrier pipelines in existence prior to highway construction or highway designation (such as an RJT), located within the operating right of way, may remain in place without protective measures provided the following requirements are met:

- Depth and existing location do not or will not conflict with highway improvements.
- The design and/or depth of the pipe are adequate to protect the pipe from loading as described in (7) below.
- Maintenance of the pipeline does not conflict with access limitations or the operational needs of the highway.
- The pipeline does not conflict with highway maintenance operations.
- The pipeline is installed to current industry and governmental standards, codes, and specifications.

Best Practice

(6) Pipeline Requirements: Location and Alignment

(a) **Crossings** – Generally, all highway utility crossings should meet the following conditions and requirements:

- Utilize subsurface construction techniques.
- Avoid impacting the roadway prism or highway drainage or other systems.
- Be located at a point that will, as much as practicable, avoid conflicts with planned highway improvements and ongoing operation and maintenance.
- Avoid installations within interchange areas. Freeway crossings should be made at locations where the chance of interference with future interchange access improvements will be minimized or avoided.
- Pipeline installation should be as normal to the centerline of the roadway as possible.
- Pipeline crossings should avoid deep cuts.
- Bridge footings, retaining walls, or other structures should be avoided whenever possible. (See [120.07](#), Bridges and Structures, for additional guidance.)

WAC 468-34-190

WAC 468-34-190(1)

WAC 468-34-190(2)

WAC 468-34-190(2)

Best Practice

- Perpetually wet areas, rocky terrain, or areas that may negatively affect highway drainage should be avoided and alternative locations considered. Alternative route analysis may be required from the utility to show that the proposed location is the only feasible location for installation.
- Wetlands or other environmentally sensitive areas should not be considered for utility installations and should be avoided whenever possible.

WAC 468-34-190(3)

- (b) **Longitudinal Installations** – When considering a proposed longitudinal utility installation, issues such as the general character of the surrounding area (rural or urbanized); the potential for local land development and subsequent increase in traffic volumes; the potential or planned highway improvements; and the right of way classification should be considered. The potential for utility relocation that may result from a highway improvement project should also be examined. When installation is necessary, all longitudinal utilities should be installed parallel to the highway centerline and as near the right of way line as possible.

WAC 468-34-190(3)

1. **Longitudinal Installations Within a Roadway or Median** – Longitudinal installations within any roadway prism or median area are a variance to WSDOT policy. Encasement requirements typically do not apply to all longitudinal installations within these areas, regardless of length of installation. (See 120.15, Casing, Conduit, Innerduct, and Encasement, for detailed guidance on encasement requirements, and 120.14, Variances: Types, Treatment, and Approval, for guidance on variance justification procedures.)

AASHTO

2. **Longitudinal Installations Within Limited Access Right of Way** – Longitudinal installations within limited access right of way are a variance to WSDOT policy. (See 120.14, Variances: Types, Treatment, and Approval, for guidance on variance justification procedures.)

(7) Pipeline Requirements: Materials and Construction

WAC 468-34-210(6)

WAC 468-34-230

WAC 468-34-250

- (a) **Pipe Material** – All pipes shall meet the following specific material and design requirements:
- Industry standards
 - Regulatory codes and specifications
 - End user product specifications

In general, WSDOT does not provide design oversight relating to utility adherence to regulatory codes. The focus of the department should be on the effects of construction, installation, and ongoing maintenance and operation of subsurface utilities upon the safety and long-term operation of the highway facility. However, this should not preclude WSDOT from identifying substandard designs or materials that may pose potentially negative or hazardous conditions upon the highway.

WAC 468-34-230

1. **Uncased Carrier Pipe** – Uncased carrier pipe shall be designed to support any highway construction or maintenance operation; the superimposed load of the highway structure itself; and any superimposed loads the roadway may be expected to withstand, including overweight loads. It is the responsibility of the utility to ensure pipe design takes into consideration how highway loading may affect the pipe under all operating ranges. Pressurized pipe must meet encasement requirements as defined in 120.15, Casing, Conduit, Innerduct, and Encasement.

(8) Trenched Construction

All trenched construction must meet the requirements of the current edition of WSDOT's *Standard Specifications for Road, Bridge, and Municipal Construction (Standard Specifications)*. When trenching and/or excavation impact the roadway prism, utility inspection oversight of the trenching work is required. The goal of trench restoration includes:

WAC 468-34-250

- Preserving the structural integrity of the roadway prism and other highway facilities.
- Securing piping material from deformation that may cause leakage.
- Avoiding the creation of drainage channels or blockage of existing subsurface drainage by placement of impervious backfill material such as may be encountered with the use of Controlled Density Fill (CDF) backfill in longitudinal trenches. The Region Materials Engineer and Maintenance Engineer, along with other region specialty groups, should review and approve longitudinal installations proposing CDF as a backfill material.

(9) Types of Trenched Construction

There are three basic types of trenches as they apply to utility accommodation. These are defined below and illustrated in [Figure 120-1](#), Types of Trenched Construction.

WAC 468-34-190

- Open cut construction: Requires cutting of existing paved roadways or shoulders, which includes both crossing and longitudinal installations as well as window cuts to accommodate bore pits or service connections.
- Trenched construction within the roadway prism: Includes longitudinal installations and window cuts to accommodate bore pits or service connections.
- Trenched construction outside the roadway prism.

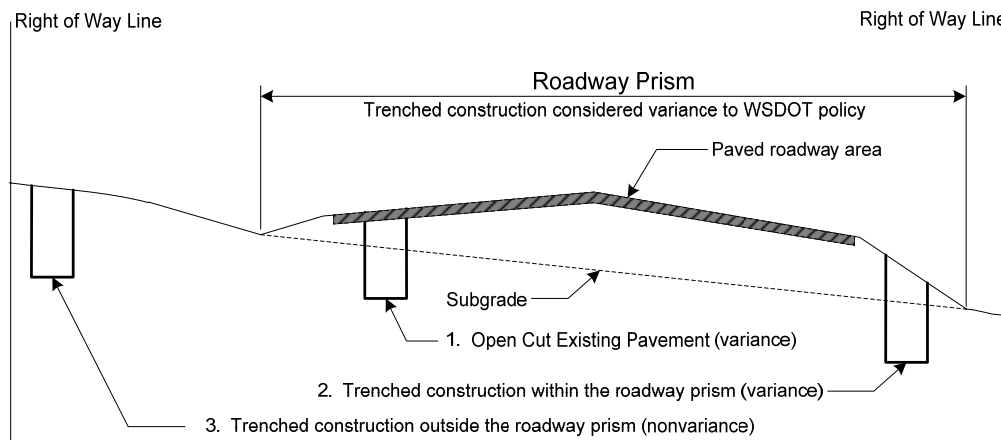

Types of Trenched Construction

Figure 120-1

(10) *Excavation in Roadway Prism*

WAC 468-34-190(4)

Excavation such as bore pits, longitudinal trenched construction, and other types of excavation within the roadway prism that is adjacent to the edge of pavement requires shoring to avoid undermining the pavement. Shoring plans should be included as part of the approved Utility Accommodation Application.

WAC 468-34-190(4)

- (a) **Open Cuts** – Open cutting the existing paved roadway or shoulder to accommodate utility construction is a variance from WSDOT policy. Open cutting should only be considered as an installation method of last resort and only after a thorough review and justification process has been completed. Other route alternatives and subsurface utility construction methods must be justifiably eliminated as viable construction alternatives before an open cut proposal will be considered. (See [120.04\(14\)](#), Trenchless Construction, for additional guidance.)

Approval of utility installations proposing an open cut requires a significant effort by both the utility and WSDOT. As such, all costs associated with the review and approval of such a proposal shall be borne exclusively by the utility.

Supporting information for the variance approval should be maintained in the franchise/permit file documenting the review and approval process. (See [120.14](#), Variances: Types, Treatment, and Approval, for detailed guidance on justification procedures for open cut proposals.)

Best Practice

1. **Open Cuts on Private Road Approaches** – WSDOT does not consider open cuts on private road approaches a variance. However the needs and desires of the permitted road approach owner should be considered when a utility installation proposes an open cut of a private road approach. The utility must give prior reasonable notice to the approach user to ensure landowner access needs are met.

All open cuts of private road approaches shall be restored to WSDOT standards. Regions should use individual judgment when considering road approach open cut proposals. Nothing in these guidelines shall prevent the region from denying an open cut request of a private approach upon the operating highway right of way.

WAC 468-34-190(4)

2. **Open Cuts on Local Agency Roadways** – Generally, open cuts of public roads such as county road intersections are discouraged. Consideration should be given to traffic volumes and disruption to local traffic when an open cut is proposed on a local agency connecting roadway within the operating highway right of way.

(11) *Trenched Crossings in Advance of Highway Construction*

Best Practice

Open trench construction proposed in advance of highway improvement projects involving the placement of new Hot Mix Asphalt at the location of the open cut may be considered without variance approval. However, this should not be considered as blanket approval for all open cut proposals in advance of construction. Factors such as traffic disruption, construction schedule, and other factors should be considered before approval is granted.

Information describing the highway improvement project should be placed in the application file documenting the decision and approval process. Detailed inspection efforts should be undertaken while the utility is being installed to ensure pipe bedding and trench backfill material is placed in accordance with WSDOT standards.

(12) Pipe Bedding and Trench Backfill Considerations

When pipe trenching is proposed, the items that should be essential considerations include:

- Restoration of the structural integrity of the roadway prism.
- Security of the pipe during placement and backfill operations against deformation that might cause leakage.
- Assurance against the trench becoming a drainage channel.
- Assurance against blocking historic or intended subsurface drainage through porous materials by placement of impervious fill materials such as CDF within longitudinal trenches.

WAC 468-34-250(1)

WAC 468-34-250(1)(a)
WAC 468-34-250(1)(b)
WAC 468-34-250(1)(c)

(a) **Pipe Bedding and Trench Backfill Requirements** – The following items are required for all trenched construction or as directed by WSDOT:

- All trenches shall be cut with vertical faces as much as may be permitted by soil and depth conditions.
- Maximum trench width shall be no more than the outside diameter of the pipe plus 2 feet.
- Shoring must meet the current Department of Labor and Industries minimum standards and as directed by WSDOT if increased shoring is needed to protect the paved roadway and/or the roadway prism.
- Unstable native materials shall be subexcavated from the trench and replaced with suitable material.
- Trench bottoms shall provide a uniform grade throughout the length of the installation.
- Pipe bedding shall be 6 inches deep or half the diameter of the pipe, whichever is less.
- Pipe bedding and backfill material and construction shall meet the requirements of the current edition of the *Standard Specifications*.
- Backfill methods shall be done to achieve prompt restoration of traffic.
- Roadway base and surfacing materials shall be cut back from the trench in a manner that eliminates roadway undermining. Base and surfacing material shall be replaced with like material as directed or defined by WSDOT.

WAC 468-34-250(2)

WAC 468-34-250(2)(a)
WAC 468-34-250(2)(b)
WAC 468-34-250(2)(c)

(13) Pipe Cover

Pipeline cover, which is defined as the distance from the finish grade of the roadway or the existing grade line to the top of carrier pipe or top of casing, if used, shall be installed at the minimum depths shown in [Figure 120-2](#), Construction Zone Cover Description, and [Figure 120-3](#), Minimum Cover Detail. Utility accommodation applications proposing to install utilities at depths less than those listed below are a variance to WSDOT policy. (See [120.14](#), Variances: Types, Treatment, and Approval, for guidance on justification requirements for shallow depth proposals.)

WAC 468-34-200

Zone Description	Min. Depth
Zone A – The roadway structure, consisting of the area from top of shoulder to top of shoulder. Includes medians of less than 16 feet in width.	60 inches
Zone B – The area 10 feet beyond the bottom of ditch, toe of slope, or back of curb, or 15 feet beyond the top of shoulder, whichever is farther.	42 inches
Zone C – The area beyond Zone B to operating highway right of way line.	36 inches

Construction Zone Cover Description
Figure 120-2

If rerouting is not possible, the pipe should be protected appropriately. (See [120.04\(13\)\(a\)](#), Shallow Pipe Installation, for additional guidance.) Utility depths should also consider variations in topography for longitudinal installations. Likewise, the minimum depth when crossing should be measured from the lowest point of the entire roadway prism.

WAC 468-34-200(1)
WAC 468-34-200(2)
WAC 468-34-200(3)

(a) **Shallow Pipe Installation** – Utility accommodation applications proposing to install utilities at depths less than those in [Figure 120-3](#), Minimum Cover for Pipe Installation, are a variance to WSDOT policy. Where unavoidable obstacles do not allow minimum cover to be attained, a new route must first be considered for placement of the pipe. In the event shallow pipe installation cannot be avoided, bridging, reinforced concrete slabs, or other suitable means approved by the department should be used to protect the pipe from operational loading, construction, or maintenance operations. (See [120.14](#), Variances: Types, Treatment, and Approval, for guidance on justification requirements for shallow depth proposals.)

WAC 468-34-200(3)

(b) **Pipe Cover for Combustible or Unstable Transmittants** – Pipelines carrying material that is flammable, corrosive, expansive, energized, or unstable shall not be considered for reduced cover variance approval. In all cases, such pipelines must meet applicable industry and government codes, standards, and specifications.

(14) Trenchless Construction

WAC 468-34-250(3)

Trenchless construction should be encouraged whenever possible. The benefits include:

- Lower construction costs versus trenched construction.
- Shorter construction duration.
- Improves highway safety when compared to open cutting and trenching.
- Minimizes or eliminates traffic control costs, detours, and road closures.
- Avoids costly trench backfill and pavement repairs and associated long-term highway maintenance issues.

The requirements for trenchless construction are as follows:

Best Practice

(a) **Trenchless Construction: Full Control Limited Access Right of Way** – Jack or bore pits necessary for trenchless construction within fully controlled limited access right of way must be placed outside the access control limits of the highway. Bore pits located within full control limited access are a variance and require appropriate justification explaining why work operations cannot be conducted from outside the limited access right of way. (See [120.14](#), Variances: Types, Treatment, and Approval, for detailed guidance on justification procedures.)

Casing is required the full width of the full control limited access right of way where required in [120.15](#), Casing, Conduit, Innerduct, and Encasement. Installations proposing other than full width casing when required are a variance from WSDOT policy. (See [120.14](#), Variances: Types, Treatment, and Approval, for detailed guidance on justification procedures.)

Best Practice

(b) **Trenchless Construction: Partial and Modified Limited Access Right of Way** – Jack or bore pits or other construction methods necessary for trenchless construction within partial or modified limited access right of way may be allowed without a variance.

Casing is required the full width of the partial or modified control limited access right of way where required in [120.15](#), Casing, Conduit, Innerduct, and Encasement. Installations proposing other than full width casing, when required, are a variance from WSDOT policy. (See [120.14](#), Variances: Types, Treatment, and Approval, for detailed guidance on justification procedures.)

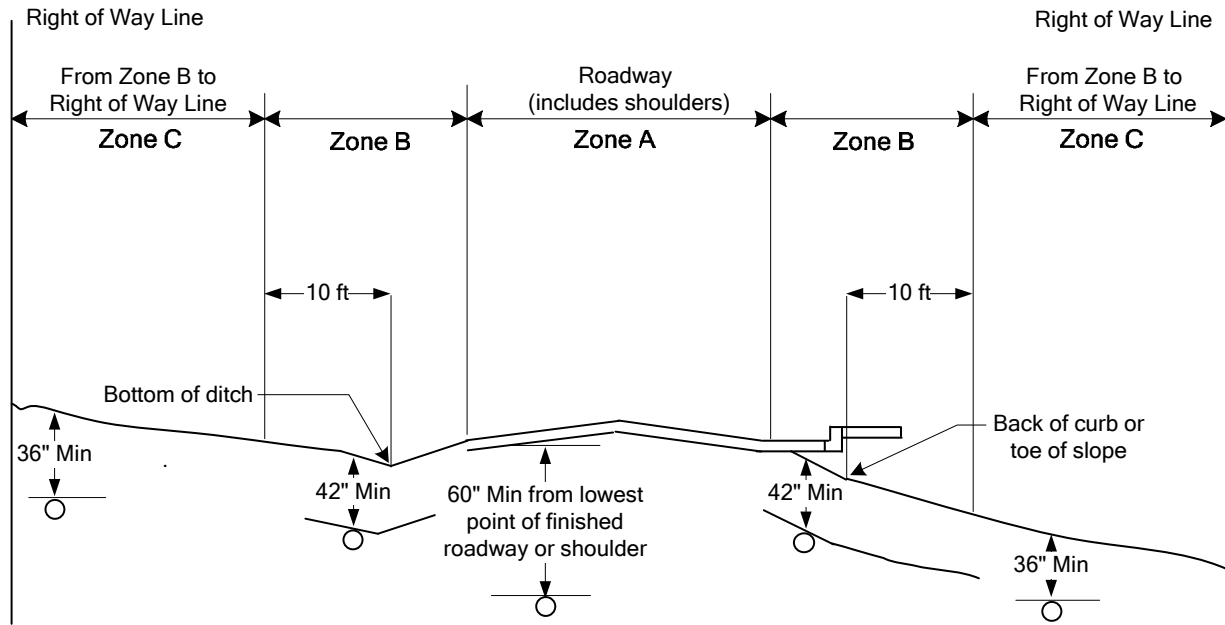

Longitudinal Coverage Detail

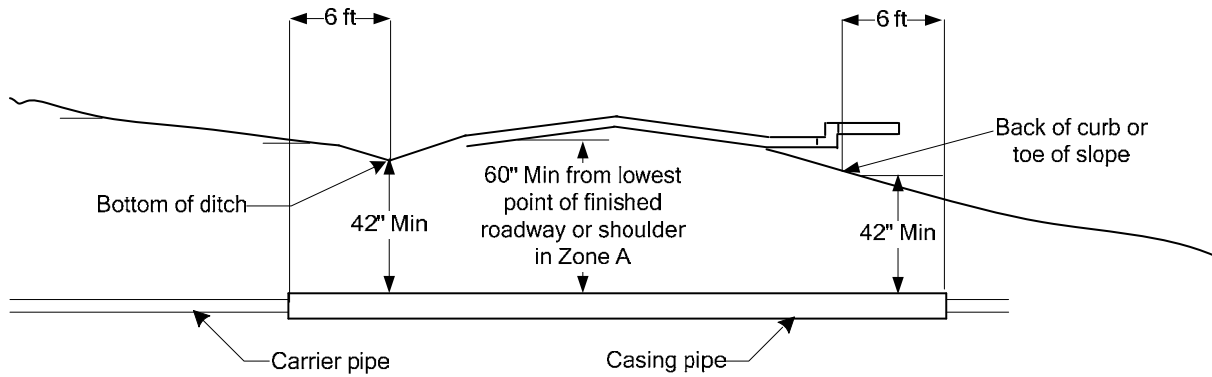

Note:
Casing pipes shall extend a minimum of 6 feet beyond the toe of fill slopes, or bottom of ditch line, or outside curb.

Crossing Coverage Detail

Minimum Cover for Pipe Installation

Figure 120-3

 Best Practice

- (c) **Trenchless Construction: Non-Limited Access Right of Way** – Jack or bore pits or other construction methods necessary for trenchless construction within non-limited access right of way may be allowed without a variance.

 WAC 468-34-250(3)

- (d) **General Trenchless Construction Requirements** – When trenchless installation techniques are used, the following requirements must be met:

 WAC 468-34-250(3)(a)

 Best Practice

- Trenchless construction method shall be reviewed and approved by WSDOT before work begins.
- Trenchless pipe installation where the casing or carrier pipe diameter is 36 inches or greater shall require a review by the State Geotechnical Engineer.
- Casing shall extend 6 feet beyond the edge of the roadway prism or back of curb. (See 120.15, Casing, Conduit, Innerduct, and Encasement, and Figure 120-3, Minimum Cover Detail, for additional guidance.)
- Limits of bore pit excavation should not extend into any portion of the roadway prism. Pit excavation work encroaching within highway drainage systems should have preapproved protective measures in place at all times during construction. Bore pits that encroach within the roadway prism shall be preapproved by WSDOT. Shoring plans for approval shall adequately present the method of shoring. Utility work that fails to follow the shoring plan should be stopped until the shoring plan is adhered to.
- The size of the bore opening shall not exceed 5% oversize in diameter. Backfill of voids in a manner approved by WSDOT, such as pressure grouting, is required for all pipes 12 inches in diameter or greater.
- Unused or abandoned holes or casings shall be backfilled as directed by WSDOT using standard methods. (See 130.06, Abandoned, Deactivated, or Disconnected Utilities, for detailed guidance.)

 WAC 468-34-250(3)(c)

 WAC 468-34-250(3)(d)

(15) Pipeline Appurtenances

Pipeline appurtenances shall meet the requirements outlined below.

 WAC 468-34-220

 WAC 468-34-220(4)

- (a) **Manholes** – Whenever possible, manholes should be located outside the roadway prism and as close to the edge of right of way as possible. Placement of manholes should be at locations that minimize interruptions to highway operation and maintenance efforts during utility maintenance work. Manholes shall not be located within any limited access highway pavement or shoulder.

 WAC 468-34-220(5)

- (b) **Automatic and Emergency Shut-Off Valves** – Automatic and emergency shut-off valves shall be located near the structure ends if attached to a structure and as may be required by WSDOT, industry standards, or governmental codes and regulations. Valves should be located in such a manner as to allow isolation of pipeline segments in the event of a hazardous condition. Shut-off valves shall not be located within any limited access highway pavement or shoulder.

(16) Pipeline Identification and Detection

 WAC 468-34-220(3)

- (a) **Markers** – Post-type markers are required for all subsurface utility installations. Markers should be installed using conspicuous colors and contain the following relevant information:

- Pipeline identification and utility station location.
- Owner of the pipeline.
- Contact phone number and other contact information with a local utility office.

- Utility size and/or capacity.
- Pipe contents.
- Warnings that may be necessary for individual utilities.
- Double markers at subsurface vaults.

1. **Marker Locations** – Markers shall be located:

- At both ends of a roadway crossing.
- At 500-foot intervals on longitudinal installations, or greater if sight distance allows.
- At all angle points.

WAC 468-34-220(3)

(b) **Locate Wire** – All subsurface installations shall be detectable by a Locate Service by way of a locate wire or other means approved by WSDOT, to be installed at the time of installation or by wire integrated into the pipe itself during manufacture.

Best Practice

(c) **Detection Tape** – Detection tape should be used for all open trench pipeline installations. The detection tape should be placed in the pipe trench 12 to 18 inches above the pipe to avoid unintentional excavation of the pipe during highway maintenance or construction operations.

Best Practice

120.05 Storm Drainage and Hydraulics

A utility permit for stormwater discharge (DOT Form 224-693) is utilized to regulate constructed facilities that discharge stormwater onto state right of way and into a highway drainage system. WSDOT will consider issuing permits for constructed facilities such as pipes, ditches, storm sewers, or other drainage facilities intended to discharge stormwater into the highway drainage system, provided that the surface runoff naturally flowed toward and onto state right of way before any alteration of the terrain caused by development. For the purpose of this section, “utility” refers to any party seeking to discharge stormwater onto or through WSDOT right of way by means of a constructed facility, as described above. Further guidelines governing the acceptance of surface runoff exist in WSDOT’s *Development Services Manual* and *Highway Runoff Manual*. Acceptance of surface runoff is subject to the following conditions:

(1) Runoff Characteristics

(a) **Rate of Flow** – Development of property tends to increase the rate of surface runoff. WSDOT will require the rate of flow entering the highway drainage system from the utility (applicant for the permit) to meet the flow control standards required in the *Highway Runoff Manual* (HRM):

- If the flow control standards required by the local government are more restrictive than the standards contained in the HRM, the local government’s standards must be used.

In some instances, WSDOT may agree to accept unrestricted runoff from a utility. However, in those instances, the utility will remain liable for damages that occur as a result of any increased runoff. The increased runoff is that portion of the total rate of flow entering the highway drainage system that is in excess of the natural rate of surface runoff that flowed toward and onto the state right of way prior to development of the property.

- (b) **Quality of Runoff** – The utility discharging runoff into a highway drainage system shall assume all responsibility and liability for the water quality of this runoff. This includes water quality both during and after development of the property in question. The water quality treatment requirements and guidelines in the [Highway Runoff Manual](#) must be followed when the local government practices stormwater management.

(2) **Runoff Management**

- (a) **Compliance** – The utility shall abide by Department of Ecology requirements and issued NPDES permits, local rules, regulations, ordinances, and resolutions. The utility discharging collected surface runoff into a highway drainage system shall be responsible for compliance with all existing and future rules, regulations, ordinances, and issued NPDES permits, and resolutions of the applicable local agency and the Department of Ecology with regard to drainage, land use associated with drainage, and water quality and quantity. All local agency permits associated with drainage in any manner shall be made part of the permit application, unless local agency approval is contingent upon a WSDOT-issued permit.
- (b) **Costs** – All costs and liabilities associated with the design, construction, maintenance, and operation of stormwater management facilities to restrict the rate of flow entering the highway drainage system or to maintain water quality shall be the responsibility of the utility.
- (c) **Connection to Highway Drainage System** – The choice of materials and the nature and details of the connection from the highway right of way line to the highway drainage system shall comply with the [Standard Specifications](#) unless otherwise approved by WSDOT. All costs associated with this connection shall be the responsibility of the utility.
- (d) **Surface and Subsurface Systems** – WSDOT will not consider appropriate the use of public land for the construction of subsurface disposal systems that would accommodate only surface runoff originating off the highway right of way. Drywells, perforated drains, and other subsurface disposal systems from a development should not be permitted on the highway right of way, regardless of the natural direction of surface flow from the property in question in the undeveloped state.

(3) **Documentation**

- (a) **Data Requirements** – The application to the region for a permit to discharge stormwater runoff into a highway drainage system shall be accompanied with the following information:
1. A statement of the design criteria used in the drainage design for the property in question. If stormwater management principles are used in the drainage design, include a description of the stormwater management design criteria used for the hydraulic analysis.
 2. A contour map of the property being drained. All contributing drainage areas identifying associated land use should be outlined on the map.
 3. A plan and profile of the proposed drainage system showing:
 - All inlets: size, type, and location.
 - All pipe sizes.
 - Location and type of manholes.

- Location and details of connection to highway drainage system and any stormwater management facilities (such as runoff treatment and flow control) and conveyance systems (such as pipes, culverts, channels, or ditches) that are part of the drainage system for the property in question.
4. Complete hydrological and hydraulic calculations for the drainage system under consideration.
 5. Details of temporary erosion control measures to prevent silts and other contaminants from entering the highway drainage system.
- (b) **WSDOT Review and Approval** – Region Hydraulics Office staff shall review all applications that propose discharge of collected stormwater into the highway drainage system. Such review shall consider:
- Whether or not the property in question drained onto the highway right of way in the undeveloped state of the property.
 - The rate of flow that flowed onto the highway right of way from the property in question in the undeveloped state of the property.
 - The rate of flow from the property in question that is proposed to enter the highway drainage system and its effect on WSDOT's system.
 - The effectiveness and adequacy of stormwater management facilities used in the system in question.
 - The future maintenance and operation of the facility that routes water to WSDOT's system.
 - The adequacy of the connection to the highway drainage system.
 - The addition of appropriate site-specific Special Provisions to the permit as noted in Special Provisions below.
- (c) **Special Provisions** – Any site-specific special provisions to the individual Permit should be added (as necessary) to DOT Form 224-157, Stormwater Permit Special Provisions, Exhibit A (see [Appendix B](#)), to clarify the utility's liabilities and responsibilities.

120.06 Open Cuts and Trenching

The purpose of this section is to explain the necessary steps involved in permitting open cuts and trenching. This includes the open cutting of a paved roadway or the open trenching outside the paved roadway.

(1) Open Cutting

Open cutting is the cutting of the existing paved roadways or shoulders.

- Open cutting the traveled lanes and shoulders of the through traffic roadways, ramps, and frontage roads on state highways is a variance from WSDOT policy. Variances must be justified as required by [120.14](#), Variances: Types, Treatment, and Approval.
- Open cutting public and private approach roads within the state's right of way is allowable under WSDOT policy.

In the decision to allow open cutting, the region should consider traffic volumes and disruption to traffic.

The policy on open cutting does not apply within the corporate limits of a city or town on non-limited access controlled highways. Utility permits and franchises in this situation are issued and maintained by the local jurisdiction. Local jurisdictions should request WSDOT review, approval, and/or recommendation prior to granting such documents.

Std. Spec. 7-08.3(3)

RCW 47.24.020(4)

The city or town shall, at its own expense, maintain all underground facilities in streets within the corporate limits, and has the right to construct additional underground facilities as may be necessary in those streets. However, pavement trenching and restoration performed as part of installation of those facilities must meet or exceed requirements established by WSDOT.

RCW 47.24.020(5)

The city or town has the right to grant the privilege to open the surface of any street within the corporate limits, but all damage occasioned thereby shall promptly be repaired by either the city or town itself or at its direction. Pavement trenching and restoration performed under a privilege granted by the city under this subsection must meet or exceed requirements established by WSDOT.

Excavations shall be performed in a manner that causes the least possible damage to highways, streets, roads, and other improvements. The trenches shall not be excavated wider than necessary for the proper installation of the utility facility. Excavation shall not be performed until immediately before the installation of conduit, cable, or other appurtenances. Excavated material shall be stored where interference to vehicular and pedestrian traffic and to surface drainage is minimized.

The following items will be addressed for each permit or franchise issued that allows open cutting:

- (a) **Inspection** – WSDOT may have an inspector on site to ensure proper backfill and surfacing material are used and required compaction is attained. (See [Chapter 7](#), Inspection, for further guidance.)

The region may impose additional charges to cover actual inspection costs. These costs are above the administration fee charged for a utility permit or franchise. For further guidance, refer to [Chapter 8](#), Reimbursement.

- (b) **Construction Requirements** – A typical open cut crossing detail, as shown in [Figure 120-4a](#), will be an exhibit of the permit or franchise issued. Any modification of the details with respect to restoration methods should be reviewed and approved by the region Utilities Office and the region Materials Laboratory.

- (c) **Maintenance Responsibility** – Add a Special Provision that makes the utility responsible for any construction deficiencies as a result of the roadway installation.

- (d) **Controlled Density Fill (CDF)** – CDF shall be used as a backfill material when directed by WSDOT. Additional requirements may include:

- CDF mix design(s) must be submitted in writing to WSDOT for approval.
- No CDF shall be placed until WSDOT has approved the mix design.
- CDF placement within the trench shall be designated by WSDOT (determined by the type of soil in the area).
- The utility shall maintain one lane of traffic open at all times during construction.
- The utility shall submit Traffic Control Plans for approval.

Std. Spec. 2-09.3(1)E

(2) Trenching for Utility Installation

Trenching takes place outside paved roadway sections. A typical open trench detail is shown in [Figure 120-4b](#). Trenching shall be constructed in accordance with the following requirements:

Std. Spec. 7-08.3(3)

- Trenching within the roadway prism is a variance from WSDOT policy. Variances must be justified as required by [120.14](#), Variances: Types, Treatment, and Approval.
- Trenching unpaved approach roads, both public and private, within the state's right of way is allowable under WSDOT's policy.
- Excavations shall be performed in a manner that causes the least possible damage to the roadway prism and other improvements.
- Trenches shall not be excavated wider than necessary for the proper installation of the utility facility.
- Excavations shall not be performed until immediately before installation of conduit, cable, or other appurtenances.
- Excavated material shall be stored where interference to vehicular/pedestrian traffic and surface drainage is minimized.
- Excavated material will be protected by BMP to prevent any environmental compliance violation.

The following items will be addressed for each permit or franchise issued that allows trenching:

- (a) **Inspection** – WSDOT may have an inspector on-site to ensure proper backfill material is used and required compaction is attained. (See [Chapter 7](#), Inspection, for further guidance.)

The region may impose additional charges to cover actual inspection costs. These costs are above the administration fee charged for a utility permit or franchise. (See [Chapter 8](#), Reimbursement, for further guidance.)

- (b) **Construction Requirements** – Construction shall be in accordance with Standard Specification 7-08.3, Construction Requirements.
- (c) **Maintenance Responsibility** – Add a Special Provision that makes the utility responsible for any construction deficiencies as a result of the installation.

Trenching through a creek, stream, wetland, or canal requires approval of the regulatory agencies of these construction activities (such as Army Corps of Engineers, city/county ordinances, DOE, DNR, tribal councils, and so on).

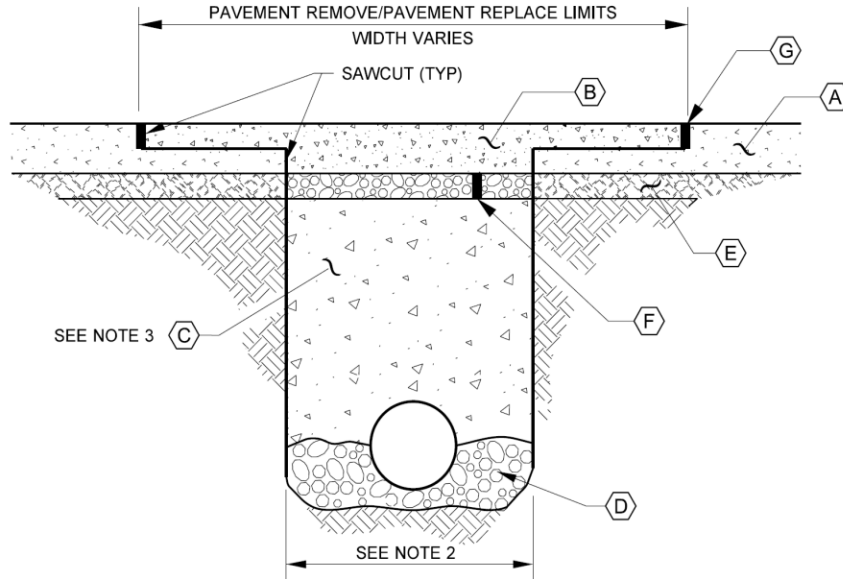

OPEN CUT CROSS SECTION
NTS

LEGEND

- (A) Existing HMA (Hot Mix Asphalt) or PCCP (Portland Cement Concrete Pavement).
- (B) HMA class 1/2 inch or PCCP: Depth and material shall match existing pavement. Removal and replacement limits of pavement to be determined at the time of utility permit/franchise review.
- (C) Approved backfill material or CDF (Control Density Backfill) or as specified by WSDOT.
- (D) Bedding material depth beneath the pipe/casing shall be six (6) inches. Additional pipe bedding shall be placed equal to half the diameter of the pipe/casing or six (6) inches, whichever is less.
- (E) Existing crushed surfacing base course.
- (F) Crushed surfacing base course depth shall match depth of existing crushed surfacing base course.
- (G) HMA butt joint requires tack, seal, and sand. For PCCP, refer to General Note 5.

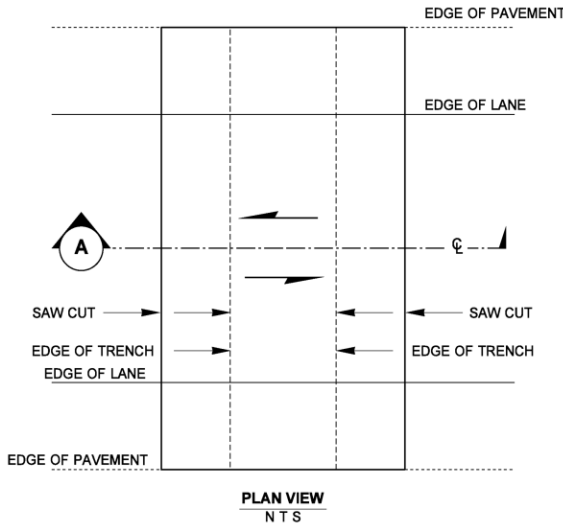

GENERAL NOTES

1. Trenching and pipe installation shall meet the requirements of WSDOT Standard Specification 7-08.
2. Maximum trench width shall not exceed casing/pipe diameter plus an additional one (1) foot on either side.
3. Compaction shall be method "C" per Standard Specification Section 2-03.3(14)C.
4. Minimum depth shall be sixty (60) inches from the finished surface to top of casing.
5. PCCP shall be replaced to the next panel joint in each direction as approved by WSDOT. All work shall be as specified in WSDOT Standard Specification Section 5-01.3(4).
6. When connecting to an existing facility under the pavement, pavement restoration may, at the department's discretion, include the full lane width and encroached shoulder.
7. Casing pipes shall extend a minimum of six (6) feet beyond the toe of fill slopes, bottom of ditchline, or outside of curb.
8. Tack asphalt per WSDOT Standard Specification 5-4.3(5)A.

Open Cut Crossing Detail
Figure 120-4a

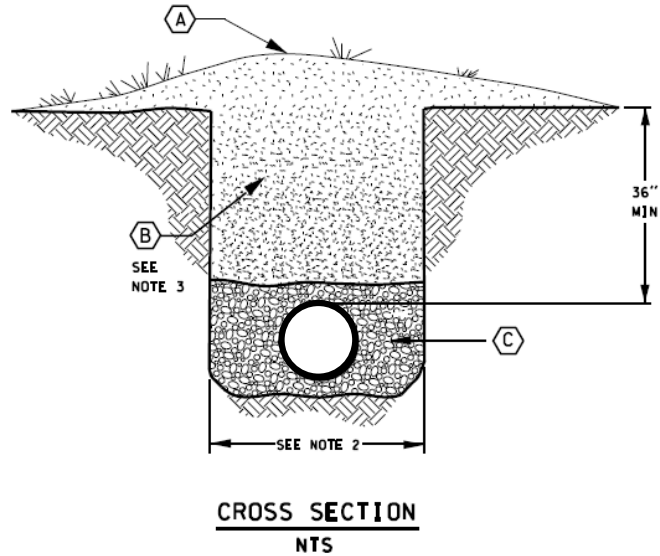
**LEGEND**

- (A) Surface treatment to restore existing to match adjacent (seeding, bark, etc.).
- (B) Native material or as directed by WSDOT.
- (C) Bedding material. Bedding material depth over and beneath pipe casing shall be half the diameter of pipe casing or 6 inches, whichever is less.

GENERAL NOTES

1. Trenching and pipe installation shall meet the requirements of WSDOT Standard Specification 7-08.
2. Maximum trench width shall be outside casing pipe width plus 1 foot either side of casing pipe.
3. Compaction shall be method _____ per Standard Specification Section 2-03.3 (14) C.
4. When connecting to an existing facility under the pavement, pavement restoration may, at the department's discretion, include the full lane width and encroached shoulder.
5. Casing pipes shall extend a minimum of six (6) feet beyond the toe of fill slopes, bottom of ditchline, or outside of curb.

Open Trench Detail
Figure 120-4b

120.07 Bridges and Structures

Utility installations on or near any highway structure listed below require review and written approval by the HQ Bridge and Structures Office prior to application approval.

- Bridges
- Approach slabs
- Retaining walls
- Noise walls
- Tunnels
- Pipe arches
- Box culverts
- Other structures

All installations shall comply with the *Bridge Design Manual* and the *Standard Specifications*.

(1) Approval and Jurisdiction

RCW 47.44.040

Prior review and approval by the HQ Bridge and Structures Office is required for utility attachments on all bridges located within the state highway system, regardless of type of right of way or jurisdiction. Attachments to bridges located on a state highway but within the corporate limits of a city or town also require prior approval by the HQ Bridge and Structures Office. The review process should verify that the bridge or structure is under state jurisdiction.

Best Practice

- (a) **State and Federal Agency Approval** – WSDOT may need to coordinate with other state or federal jurisdictional agencies when authorizing utilities to be attached to highway structures. Refer to [Chapter 5](#), Government Agencies: State, Federal, Tribal, and Other Entities, for additional guidance on coordination requirements.

(2) Bridge Structures

Bridges consist of two basic elements: substructure and superstructure. Utilities proposing to attach to, or be installed near, any portion of the substructure or superstructure require written approval of the HQ Bridge and Structures Office and, in some regions, review and/or concurrence by the region Bridge Maintenance Office prior to approval of application to do so.

Standard
Specifications

- (a) **Substructure** – The substructure is that portion of a bridge that supports the elements of the superstructure or that part of the structure as follows:
- Everything below the bottoms of the grout pads for simple and continuous span bridges.
 - Everything below the bottom of the girders or bottom slab soffits.
 - Arch skewbacks and construction joints at the top of vertical abutment members or rigid frame piers.

Substructure elements include the following:

- Piles
- Footings
- Seals
- Abutment walls, retaining walls, and endwalls
- Piers
- Wingwalls
- Barrier and railing attached to wingwalls and cantilever barriers and railings

Subsurface utilities installed near the substructure must take into account that the geophysical properties of the material surrounding the substructure and other factors eliminate negative impacts to the stability of the structure as a whole.

- (b) **Superstructure** – The superstructure is that portion of a bridge supported by the substructure, that is above the substructure, and that extends:
- From the back of pavement seat to the back of pavement seat when the endwalls are attached to the superstructure.
 - From the expansion joint at the end pier to the expansion joint at the other end pier when the endwalls are not attached to the superstructure.

Superstructure elements include, but are not limited to, the following:

- Girders
- Slabs
- Barrier
- Railing elements attached to superstructure elements

Utility conduits are often preinstalled within the superstructure to accommodate existing or proposed utilities.

- (c) **Other Structures** – Utility installation on or near other structures such as retaining walls, noise walls, sign bridges, or bases for light and signal poles may require approval by one or more Headquarters offices, including Bridge and Structures, Bridge Preservation, and Geotechnical, as well as region Bridge Maintenance.

(3) Bridge Installation Proposals

- (a) **Submittal for Review and Approval** – Early and frequent communication with the HQ Bridge Preservation Office is necessary when a utility installation is proposed on or near a structure. This is especially true for structures located within local agency jurisdictions where utility permitting authority rests with the local agency. Contact the HQ Bridge Preservation Office to determine what information may be necessary for approval of a particular bridge attachment, including planned bridge rehabilitation or replacement.

1. **General Submittal Information** – Submittals to the HQ Bridge and Structures Office for the review and approval of bridge attachments, subsurface installations, or aerial installations near a structure must include enough information to clearly illustrate how the utility is to be installed. Generalized, vague, or incomplete information may delay the approval. An application should be considered incomplete until enough information is received to allow a meaningful review.

All review transmittal packages sent to the HQ Bridge and Structures Office for review should include the following:

- Franchise or permit number
 - State route number and milepost
 - Bridge number
 - As-built bridge details
 - Cross sections
 - Reimbursable account number
 - Other pertinent information
2. **Local Agency Jurisdiction Submittals** – Bridge attachment submittals for installations within local agency jurisdictions that are not within limited access right of way should also include the name and contact information for the local agency.

3. **Bridge Attachment Submittals** – In addition to general submittal information, utilities proposed to be attached directly to a structure should include the following documents with the review transmittal:
- Bridge attachment details. (See [Figure 120-5](#), Utility Installation Guideline Details for Existing Bridges: Utility Hanger Details, for additional information.)
 - Engineering calculations for attachments involving pressurized pipe systems, heavily loaded utilities, or as requested by the HQ Bridge and Structures Office.
 - A plan and elevation view showing the proposed utility location on the structure.
 - Horizontal dimensions from all bridge primary members (girder, stringer, beam, edge of slab, and so on).
 - Anchor details or catalogue cuts with material specifications and proposed spacing, embedment depth, method of installation, and loading calculations.
 - Utility line expansion joint details and proposed locations.
 - Detail of bridge abutment showing the method of transitioning the utility off the bridge. Any excavations or borings at these locations should include a cross section with horizontal and vertical offsets.

(4) Subsurface Installations Near Structures

The HQ Bridge and Structures Office must preapprove all excavations and borings that meet the following:

- Below a footing, seal, or pile group.
- Within a horizontal distance equal to twice the footing width from any edge of a footing.
- Below a 45 degree envelope from the bottom of any edge of a footing. [Figure 120-6](#), Zone of Influence, illustrates these limits. (See also [Figure 120-7](#), Subsurface Bridge Submittal Example.)
- A plan and elevation profile of the proposed utility location with references identifying adjacent bridge piers or retaining walls by WSDOT bridge name, and bridge, pier, or wall number.
- Information regarding the proposed method of installation.
- A location cross section showing the horizontal and vertical relationship between the proposed installation and any adjacent bridge pier footings, wall footings, or existing utilities.
- Any datum equations used to compare utility elevations to bridge as-built elevations.

Pressurized utilities installed within the Zone of Influence must be encased to minimize undermining of the substructure in the event of damage or rupture to the carrier pipe. (See [120.15](#), Casing, Conduit, Innerduct, and Encasement, for additional guidance.)

(5) Aerial Installations Near Structures

For bridge maintenance and inspection purposes, aerial utility installations shall not be installed within 30 feet of any structural element. Aerial utilities proposing to be installed within 30 feet of any structure should be submitted for review and approval by both the HQ Bridge Preservation Office and the region Bridge Maintenance Office.

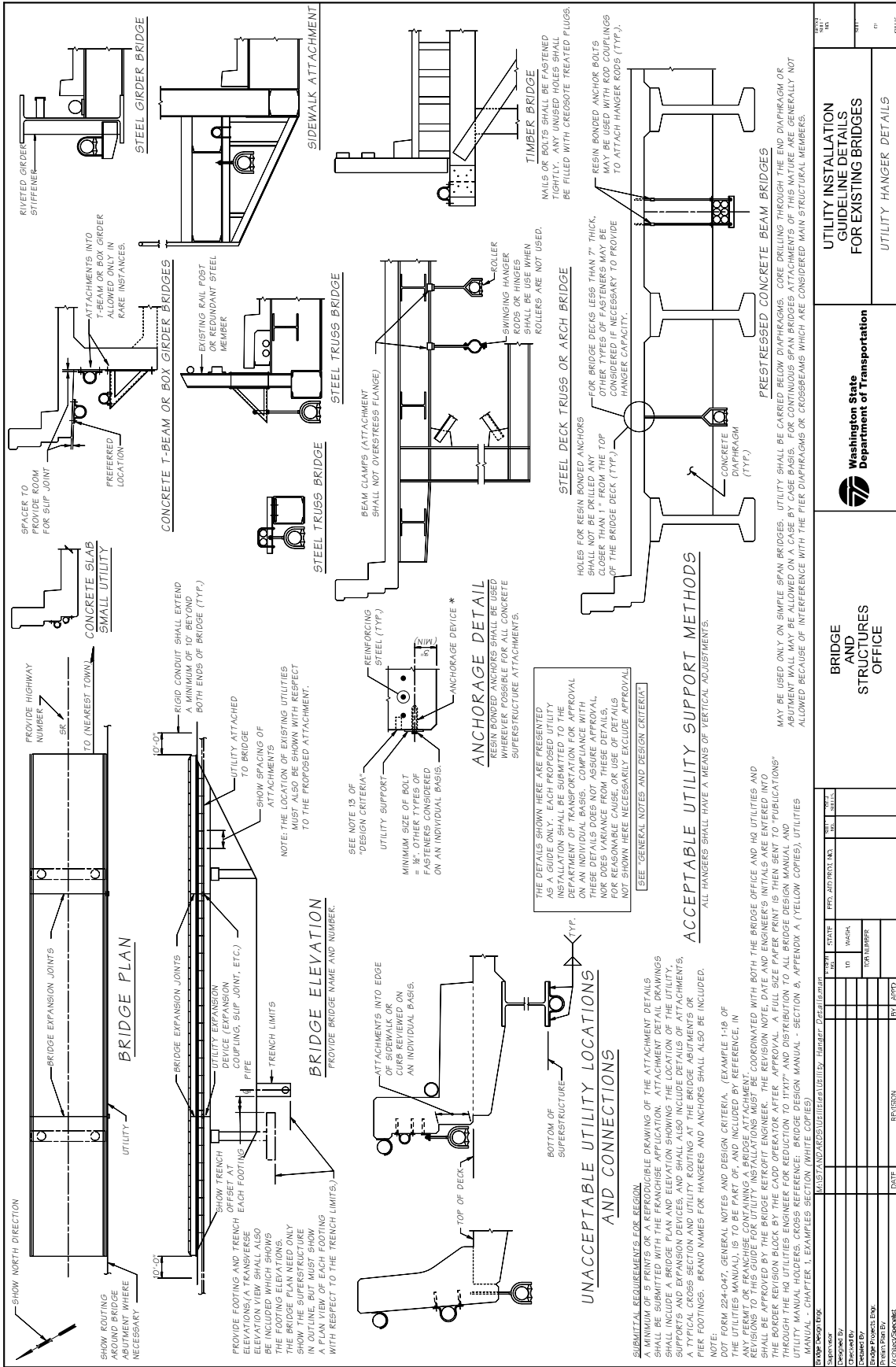

Utility Installation Guideline Details for Existing Bridges: Utility Hanger Details
Figure 120-5

(6) Bridge Attachment Requirements

Proposed utility installations must be submitted to the HQ Bridge and Structures Office for preapproval on an individual basis.

Compliance with standard attachment details does not constitute automatic approval. Installations that deviate from standardized attachment details or preapproved attachment requirements without prior approval from the HQ Bridge and Structures Office will be subject to removal.

WAC 468-34-270

(a) **Design Considerations and Criteria** – At a minimum, all utilities attached to or installed near a bridge or other structure shall meet the design requirements set forth below. These criteria should be used in conjunction with the *Bridge Design Manual*.

WAC 468-34-270

1. **General** – All installations shall meet the requirements of WSDOT’s most recent edition of the *Standard Specifications*.
 - Each proposed bridge attachment should be considered on its individual merits and separately designed to be compatible with the appearance of the structure.
 - Existing structure must be able to support the additional load of the proposed utility.
 - Installation shall not impede in any manner the painting, maintenance, or inspection of the structure.
 - Manholes, hand holes, or similar utility elements shall not be installed in the bridge deck on overcrossings.
 - Attachments on a structure of a pipeline carrying a hazardous material shall be avoided where feasible and where other installation alternatives exist, such as jacking or boring at or near the structure location.

In all cases, the utility is responsible for restoration and repair of damage to structures as a result of the construction and operation of the utility.

WAC 468-34-270

2. **Materials, Design, and Casing** – All pipes carrying transmittants that are flammable, corrosive, expansive, energized, or unstable shall be encased throughout the length of the structure. A sleeve approximately 3 inches larger than the outside diameter of the carrier pipe shall be used. The space between the pipe and the casing must be effectively vented at each end. All piping systems under pressure shall state the maximum operating pressure and test pressure on the plans and on the label. (See 120.15, Casing, Conduit, Innerduct, and Encasement, and 120.04(16), Pipeline Identification and Detection, for additional guidance.)
 - Utilities shall be provided with suitable expansion devices near bridge expansion joints and/or other locations as required to prevent temperature and other longitudinal forces from being transferred to bridge members.
 - Utility supports shall be designed such that any loads imposed by the utility installation do not overstress the conduit, the supports, or the bridge members.
 - Utility locations and supports shall be designed so that a failure, such as a rupture, will not result in damage to the bridge or the surrounding area, nor become a hazard to traffic.
 - Conduit shall be rigid.
 - Lag screws may be used to attach brackets to wooden structures. All bolts holes shall meet the requirements of Sections 6-04.3(4) and 6-04.3(5) of the current edition of WSDOT’s *Standard Specifications*.

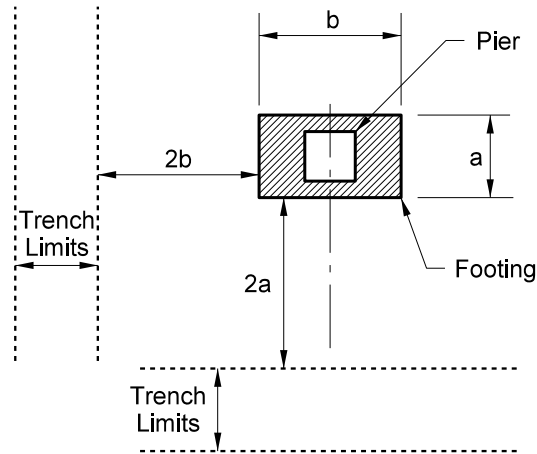
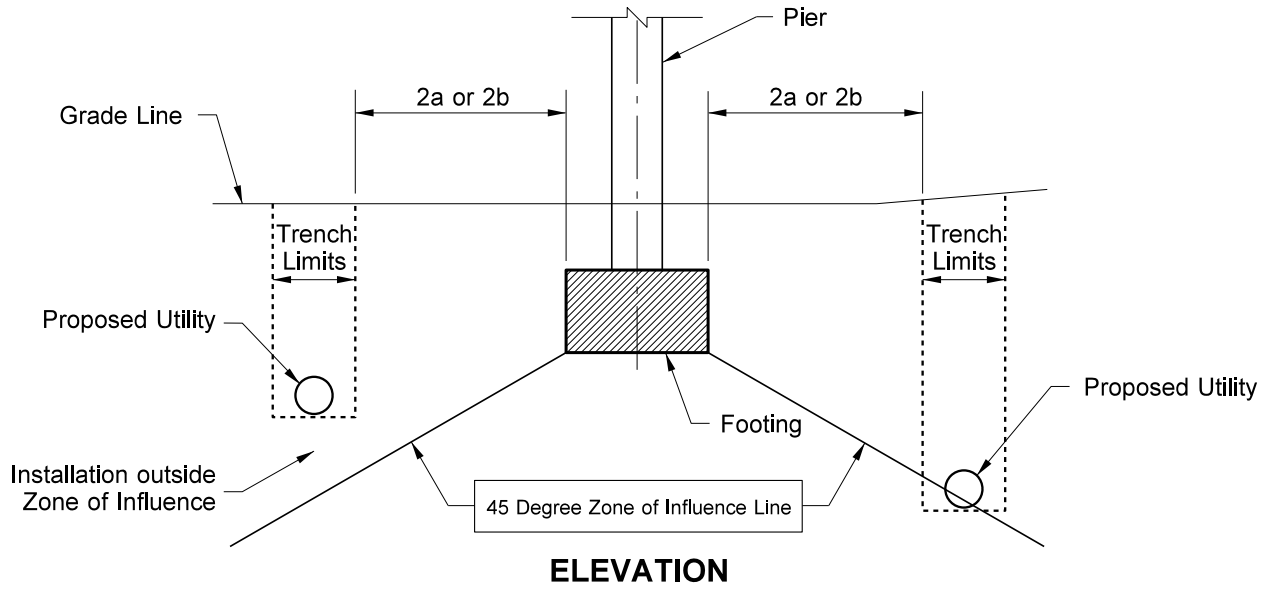

Zone of Influence
Figure 120-6

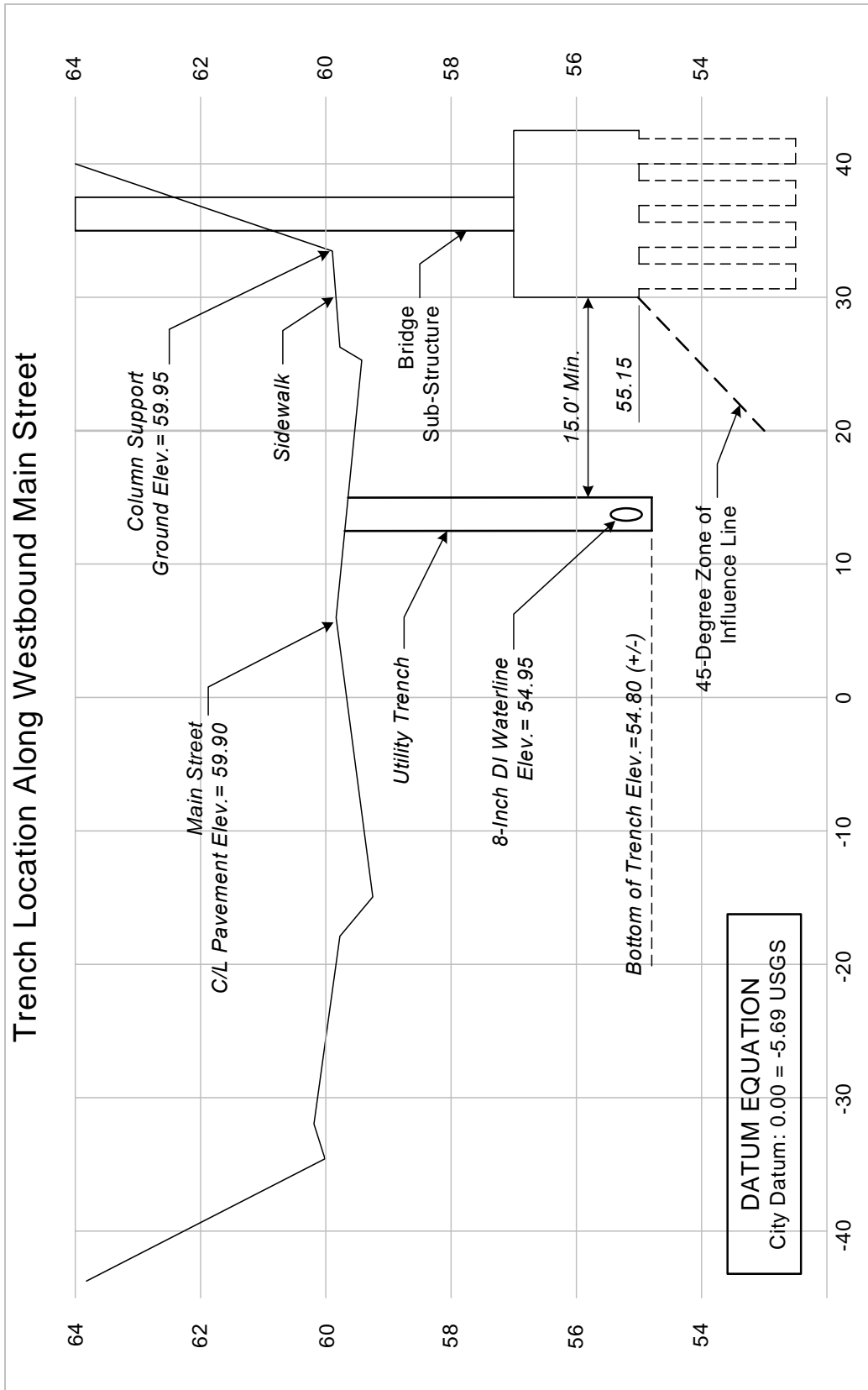

Subsurface Bridge Submittal Example
Figure 120-7

- Welding across main members will not be permitted. All welding must be approved.
- Conduits or brackets shall be attached to concrete superstructure members with resin bond anchors. Lag screws shall not be used for attachment to concrete.
- Drilling through concrete reinforcing steel in concrete structures is not permitted. If steel is hit during drilling, the anchor location must be moved and the abandoned hole filled with nonshrink grout conforming to the requirements of Section 6-03.3(36) of the current edition of WSDOT's *Standard Specifications*.
- There shall be a minimum of 3 inches edge distance to the centerline of bolt holes in concrete.
- All utilities and utility supports shall be designed not only to support their dead load but also to resist other forces from the utility, such as surges, wind, or earthquakes. The utility company may be asked to submit one set of calculations to verify utility design forces.
- Drilling into prestressed and post-tensioned concrete members for utility attachments shall not be allowed.
- Water or sewer lines to be placed lower than adjacent bridge footings shall be encased if failure can cause undermining of the footing.
- All steel in utility supports, including fastenings and anchorages, shall be galvanized in accordance with AASHTO M-111 or M-232 (ASTM A-123 or A-153, respectively).
- Rigid conduit shall extend a minimum of 10 feet beyond the end of the bridge and bridge approach slabs.

3. Location and Placement

- Utilities shall not be attached above the bridge deck or to railing or rail posts.
- Utilities shall not extend below the bottom of the superstructure.
- Whenever possible, all utility installations shall be hidden from view.
- Utilities shall be located to minimize bridge maintenance and inspection requirements. Coordinate installation proposals with the region Bridge Maintenance Office.
- Utility positioning on a structure that inhibits access to any structure part for bridge painting, repair, or maintenance should not be allowed.

WAC 468-34-270

4. Appearance – All utilities and utility support surfaces, including any galvanized utilities, shall be given a primer coat of state standard formula A-6-86 and two coats of state standard formula C-9-86. The final coat shall match the color of the bridge or structure. Utilities hidden from view, such as those installed within box-girder bridges, are exempt.

WAC 468-34-270

- All painted surfaces damaged during construction shall be cleaned and painted as noted above.
- Appearance of the utility installation shall be given serious consideration in all cases. Where possible, the utility installation shall be hidden from public view.
- Any and all paint splatters and overspray shall be removed from the structure to the satisfaction of WSDOT.

(7) Utility Encasement

WAC 468-34-210
WAC 468-34-270

All encasement requirements of the *Utilities Accommodation Policy* shall be met for attachments to structures or for subsurface utilities installed within the Zone of Influence. (See 120.15, Casing, Conduit, Innerduct, and Encasement, for additional guidance.)

WAC 468-34-210

(a) **Piping, Encasement, and Conduit Labeling** – Piping, conduit, and casings for utilities shall be installed with labels. Labeling and label material and installation shall conform to Section 6-01.10 of WSDOT’s *Standard Specifications* or the corresponding section of the most current edition.

Labels shall be color-coded based on the type of utility, with corresponding lettering as follows (see Figure 120-8, Utility Marking Convention):

- Label Background Color
- Content
- Lettering Utility Color

Label Background Color/ Lettering Utility Color	Content
RED	Electrical Power
YELLOW	Gas, Oil, Steam, Petroleum, and Other Gaseous Materials
ORANGE	CATV, Telecommunication, Alarm, and Signal
BLUE	Potable Water
GREEN	Sewer and Storm Drain
PINK	Temporary Survey Markings
WHITE	Proposed Excavation
PURPLE	Reclaimed Water, Irrigation, Slurry – <u>Nonpotable water</u>

Utility Marking Convention
Figure 120-8

120.08 Scenic Classification Policy

(1) General

WAC 468-34-330

The Scenic Classification Policy exists to preserve scenic views visible from state highways. In general, this policy establishes when and under what conditions utility facilities must be installed underground when they would otherwise be allowed to be installed as aerial facilities. These scenic classifications are based on various scenic values along the roadway, including roadway appearance, that may be attainable after ultimate improvements within the right of way.

(2) Roadway Scenic Classification Definitions

WAC 468-34-330(3)

Each scenic class represents the view from the roadway ranging from highest to lowest view quality. There are four individual scenic classifications:

(a) **Scenic Class A** – Areas of superior scenic quality consisting of panoramic views from the highway of ocean beaches, scenic valleys, lake frontage, mountains, forests, rivers, and so on. This scenic class may also include unique historical or cultural settings of superior quality that should be protected or preserved by special treatment for future generations.

- (b) **Scenic Class B** – Locations of high scenic quality where valuable scenic and environmental amenities exist, that are generally enjoyed by travelers and the public, and that deserve serious consideration for preservation and protective measures.
1. **Scenic Subclass X – Scenic Flexibility** – An alternative to Scenic Classes A and B. This class is for use in areas where utility or highway design alternatives, such as configurations, color, location, or other design features, may allow an aerial facility without significantly changing the landscape quality. Aerial facilities must be acceptable to WSDOT and substantiated by appropriate documentation describing the decision-making and justification processes.
 2. **Scenic Subclass X – Provisional Designation** – Route Jurisdiction Transfer (RJT) highways are designated Scenic Class BX(p) on a provisional basis until a Scenic Classification Review Team can be arranged to provide a formal classification designation. Regions should submit a request for formal review of RJT highways to [HQ Utilities](#).
- (c) **Scenic Class C** – Areas of secondary scenic importance. Scenic characteristics are of marginal importance.
- (d) **Scenic Class D** – Areas of industrial development or areas heavily urbanized or deteriorated. Areas where the expense for beautification measures may not be appropriate.
- (e) **Route Jurisdiction Transfers and New Highways** – New highways or roadways whose ownership is transferred to WSDOT from another agency will receive a provisional scenic classification of BX(p) until a field review of the highway can be conducted by a Scenic Classification Review Team.

(3) **New Utility Installations**

- (a) **Scenic Classes A and B** – New utility installations shall be installed underground unless otherwise justified by “Special Exceptions,” noted in [Existing Utility Facilities](#) below. New aerial utility installations proposed within Scenic Classes A and B shall be considered a variance to the Scenic Classification Policy and require reasonable justification. (See [120.14](#), Variances: Types, Treatment, and Approval, for additional guidance.)
- (b) **Scenic Subclasses AX and BX** – Aerial installations may be allowed with justification.
- (c) **Scenic Classes C and D** – Aerial installations are allowed.

WAC 468-34-330(1)

(4) **Existing Utility Facilities**

Existing aerial utilities authorized by franchise within Scenic Class A or B may be renewed for one additional franchise period, as defined [100.02\(3\)](#), Franchise Consolidation, and [100.02\(4\)](#), Franchise Renewal. Upon expiration of the Franchise Renewal, the utility must be placed underground unless the utility has gone through the justification process to remain aboveground. In such cases, the following “Special Exceptions” shall be included in the Franchise Renewal:

WAC 468-34-330(1)

- Upon expiration of this franchise or permit, the utility shall place the existing aerial facility underground in those locations where the facility exists within Scenic Class A or B.
- The utility shall submit a written request and justification within 180 days of expiration of this franchise petitioning WSDOT to allow the existing aerial facility to remain aboveground.

Best Practice

- (a) **Joint-Use Utility Facilities** – Third-party utilities installed upon an existing utility plant within Scenic Class A or B may be installed to the extent that only the existing utility poles may be used. Installation of a new utility pole to accommodate an aerial crossing from an existing utility pole should not be considered. Rather, the utility should make the crossing underground.
- (b) **Joint-Use Utility Facilities: Franchise Expiration** – Third-party utilities installed by franchise upon an existing utility plant should have the same expiration date as the existing franchise. Utilities proposing to make such an installation should be informed, in writing, of the status of the existing utility franchise. Such information should include:
- Scenic classification.
 - Existing franchise expiration date.
 - Undergrounding expectations.
 - Warning that the proposed utility may incur additional expense due to the necessity to underground in the near future.
 - That such expense is to be expected and may not be considered under “Special Exceptions” in [Variance From the Scenic Classification Policy](#) (below).

(5) **Aboveground Utility Reconstruction and Maintenance**

WAC 468-34-330

- (a) **Utility Reconstruction** – Utility reconstruction is defined as the replacement of 25% of any utility poles, towers, or similar aboveground utilities within a mile of a highway. Individual periodic pole or tower replacement is exempt. When such reconstruction is to be done upon an aerial facility within Scenic Class A or B, the facility shall be reconstructed underground as defined by this section.
- (b) **Utility Maintenance** – Utility maintenance is defined as regular and routine maintenance of a utility, including individual replacement of any aboveground facility.

(6) **Variance From the Scenic Classification Policy**

Utilities may be eligible for a variance from the Scenic Classification Policy requirements if one or more of the following “Special Exceptions” is present:

WAC 468-34-330(2)

- Power lines are in excess of 35 Kv.
- Alternative installation locations are unavailable.
- Alternative installation locations are unusually difficult and/or costly.
- Alternative installation locations are more undesirable from a visual quality standpoint.
- Underground installation of utility is not technically feasible.

If a utility wishes to apply for a variance from WSDOT policy, a [Scenic Classification Variance Request Justification](#) (see [Appendix B](#)) must be submitted and maintained in the accommodation document file.

(7) **Scenic Class Reevaluation**

Scenic classification designations should be updated periodically as determined by WSDOT. Designations may be disputed by utilities.

- (a) **Scenic Classification Disputes** – Utilities have the option of disputing existing scenic classification designations. Utilities wishing to dispute existing designations relative to a proposed utility installation must start the variance process and indicate the desire to dispute the existing scenic classification designation. Upon receiving the variance justification package, the Region Utilities Engineer should review the circumstances

and conditions relative to the dispute and provide a findings and recommendation to the HQ Utilities Engineer for further action.

- (b) **Scenic Classification Reevaluation: Department-Initiated** – Regions should conduct reviews of existing roadway scenic classifications periodically to determine which routes to consider for scenic class reevaluation. Include at least the following types of areas:
- Urban growth expansion.
 - Business and industrial development.
 - New roadway cuts, noise walls, or similar infrastructure features.
- (c) **Scenic Classification Review Team** – Forward scenic classification disputes or recommendations for reevaluation to HQ Utilities. Headquarters will arrange and coordinate a regional or statewide review by a Scenic Classification Review Team consisting of the following:
- HQ Landscape Architect (Permanent Member)
 - HQ Utilities Representative (Permanent Member)
 - Utility industry representative
 - Region Utilities Engineer
 - Region Landscape Engineer or other region designee
- (d) **Cost Responsibility** – Utility industry representatives will be responsible for their costs. WSDOT will be responsible for its costs.

120.09 Control Zone

All proposed aboveground utility installations within the operating highway right of way must meet the requirements of the Control Zone Guidelines outlined in [Chapter 9](#). Additionally, WSDOT must manage all existing aboveground utilities within the right of way to ensure compliance with Control Zone requirements as opportunities become available. The Control Zone Guidelines govern the location of utilities within the right of way for:

- New installations or reconstruction.
- Highway projects involving safety improvements.
- Franchise Renewal or Consolidation of existing utility objects.

(1) Utility Maintenance

WSDOT defines utility maintenance as isolated work to damaged or deteriorated facilities. However, work that increases the size or capacity of that utility is treated as a new installation and requires an approved permit or Franchise Amendment from the department. Physical movement, upgrade, or reinforcement of a utility is considered reconstruction and not maintenance.

Work considered to be utility reconstruction includes, but is not limited to:

- Utility pole replacement (see [900.10\(2\)](#), Existing Utility Reconstruction).
- Any increase in utility quantity, size, or capacity.
- Reinforcement or stabilization of any aboveground utility.

Upon review of the proposed utility work, WSDOT may require relocation of the existing utility.

WAC 468-34-350

(2) Utility Reconstruction

Opportunities for safety improvements should be discussed with utility owners when existing utility reconstruction is proposed (see [Chapter 9](#)).

(3) Department Coordination

Best Practice

Each region is encouraged to develop and coordinate communication and training with area maintenance forces that define reporting and responsibilities for proposed utility maintenance and utility improvement approvals.

120.10 Joint-Use and Future-Use Utilities

Joint-use utilities are third-party utilities installed upon or within a primary utility's existing infrastructure such as utility poles or conduit. Future-use conduit placement is encouraged when opportunities arise.

(1) Purpose and Need

Maintaining accurate records of ownership of third-party utilities is a critical requirement. Accurate ownership details can reduce or eliminate unnecessary delays and costs associated with the utility relocation efforts necessary on highway improvement projects. WSDOT should work in a positive and cooperative manner with utilities that may be in a position to allow other utility organizations' infrastructure to be installed upon or within their existing facilities. Utilities should be made aware of some of the benefits of a positive working relationship with the department in this regard, including:

- Accurate and up-to-date records.
- Cost recovery.
- Reduced administrative overhead, especially relating to utility relocations where the utility has no compensatory rights.

(2) Conduit for Future Use

The installation of empty conduits for future use during the construction of a highway project's other utility work should be encouraged. This potentially reduces or eliminates future interruption to traffic and offers flexibility to the utility owner and others wishing to lease or purchase the rights to use the conduit.

- (a) Documentation of New Empty Conduit** – The following requirements apply to empty conduit:
 - Conduit may only be used by the utility that applied for the initial installation unless there is a lease agreement or formal change of ownership (see [130.05](#), Utility Transfer of Ownership – Acceptance of Assignment).
 - Conduits must be applied for as “Empty Conduit for Future Use.” All accommodation requirements apply to the application.
- (b) Vacant Conduit: Lease** – Third-party utilities must apply for an accommodation document when leasing vacant conduit. A copy of the lease agreement must be attached to the application indicating a legal right to make the installation within the primary utility's conduit.
- (c) Vacant Conduit: Purchase** – New utility facilities installed in existing conduits after a fee-simple purchase must first satisfy the requirements of the Acceptance of Assignment process before an accommodation document will be issued.

- (d) **Joint-Use Conduit: Franchise Expiration Date** – Franchises for leased conduit or conduit of fee-simple purchase of conduit by a third party located within the same gallery of conduits shall all expire at the same time as the franchise that originally placed the conduit. This allows WSDOT the opportunity to review the status of the entire gallery of conduit at the time of expiration and, if needed, coordinate joint trench relocation or address other needs.

(3) **Joint-Use Utility Poles**

A third-party utility wishing to attach its facility to existing utility poles must provide a Joint-Use Agreement, or other documentation deemed suitable by WSDOT, indicating that permission has been granted by the utility pole owner. Language should be included in the franchise Special Provisions that makes the primary pole owner responsible for any other utilities that are allowed on the pole by the pole owner. This responsibility will include future relocations required by either the pole owner or department needs.

Similar to joint-use conduits, third-party installations upon a primary utility's poles shall expire on the same date as the existing utility franchise to facilitate Consolidation, Renewal, and relocation issues.

- (a) **Joint-Use Utility Poles: Relocation** – In most cases, utilities attached to poles shall relocate together at such time as WSDOT or the originating utility deems relocation necessary. The pole owner is responsible to remove the pole or poles in their entirety.

120.11 Access Control

(1) **Access Types**

There are two types of access control on highway rights of way that affect utility accommodations. These are non-limited access (managed access) and limited access.

- (a) **Non-Limited Access** – This type of right of way is defined as a conventional highway where access control has not been established by WSDOT. This is also known as managed access control. Label this type of right of way as “None” in the Access Control box of DOT Form 224-697, Utility Facility Description.

WAC 468-51
WAC 468-52

- (b) **Limited Access** – Limited access is the type of highway right of way where the right to access is controlled. Any installation requiring an access break requires Headquarters Access and Hearings approval. Accommodation of utility installations is restrictive within this type of right of way. Limited access is divided into the following types:

WAC 468-54
WAC 468-58

- Full access control: Generally allows access connections only at selected public roads.
- Partial access control: Generally allows access connections at selected public roads and some crossings and private driveways.
- Modified access control: Generally allows access connections at most approaches and includes existing commercial approaches.

WAC 468-34-110(3)(a)-(c)

Label this type of right of way as Full, Partial, or Modified in the Access Control box of DOT Form 224-697, Utility Facility Description, Exhibit B (see [Appendix B](#)).

1. **Full Access Control** – Longitudinal utility installations within full control limited access right of way are a variance to WSDOT policy and require justification. (See [120.14](#), Variances: Types, Treatment, and Approval, for additional guidance.)

Utility installations other than crossings normal to centerline are discouraged.

For the purpose of processing utility franchises and permits, the term full access control is inclusive of all highway facilities designated as full control limited access by WSDOT.

- a. **Interstate** – Access for utility installations within this type of right of way is highly restrictive.
- b. **Non-Interstate** – Utility installations within full access control of right of way are restrictive.

Label this type of right of way as “Full” in the Access Control box of DOT Form 224-697, Utility Facility Description, Exhibit B (see [Appendix B](#)).

WAC 468-34-110(3)
WAC 468-34-110(3)(a)
WAC 468-34-110(3)(d)

2. **Partial and Modified Access Control** – For the purpose of processing utility franchises and permits, modified and partial controlled access are treated the same. Justification must be reasonable and satisfactory to WSDOT. (See [120.14](#), Variances: Types, Treatment, and Approval, for additional guidance.)

Label this type of right of way as “Partial” or “Modified” in the Access Control box of DOT Form 224-697, Utility Facility Description, Exhibit B (see [Appendix B](#)).

(2) Signature Authority

Refer to [100.06](#), Approval Authority, for detailed guidance regarding approval authority for accommodation documents.

120.12 Environmental Considerations

WSDOT accommodation documents require utility applicants to secure all environmental permits for a utility installation. (See EF 224-030, Special Provisions for Permits and Franchises.) For further information on environmental considerations, see WSDOT’s [Environmental Procedures Manual](#), [Design Manual](#), and [Maintenance Manual](#).

(1) Utility Environmental Permit Compliance

WSDOT is not a regulatory agency. Thus, when a utility affirms that all of the necessary environmental permits are complete, it is not the department’s responsibility to obtain proof of the permit completion. If a hazardous spill or environmental damage occurs, the utility is responsible for corrective action.

(2) WSDOT as Land Owner

The risk to WSDOT as the land owner occurs when the utility owner and/or the utility’s contractor are financially small and not able to abate or correct their environmental damage. Theoretically, WSDOT could be required to correct the damage with department funds. WSDOT would then be in the position of attempting to collect expenses from the small utility, the utility’s contractor, and its bonding and insurance companies. The utility would have an interest in satisfying the debt if it desired to continue occupying highway right of way. The utility contractor could suffer remedies involving bonding and licensing.

(3) Corrective Action by WSDOT

If a hazardous spill or a deteriorating environmental situation (such as stormwater or air quality) occurs during utility installation or facility operation, the responsible utility representative should be notified of the situation as soon as possible. If any delay in taking the necessary corrective action appears likely, WSDOT has the right and responsibility to take corrective action. WSDOT may mobilize department staff, engage outside assistance to control the situation, or notify the Department of Ecology Spill Response Team as deemed appropriate by the department. The utility representative must be advised that WSDOT will hold the utility financially responsible for all costs incurred for the department's corrective actions. This notification will allow the utility the option to mobilize and assume the abatement actions with utility staff and/or contractors.

(4) Environmental Requirements for FHWA Approvals

FHWA's review and approval of utility design variances and limited access breaks within interstate rights of way constitute a federal nexus that results in the requirement for NEPA, ESA, and NHPA Section 106 compliance.

- (a) **NEPA Documentation** – FHWA's approval of utility installations along or across a transportation facility is categorically excluded under NEPA, pursuant to 23 CFR Section 771.117(c)(2); however, FHWA requires WSDOT to provide verification of this categorical exclusion for each installation. At a minimum, the region Environmental Manager must provide written verification to FHWA that 23 CFR Section 771.117(c)(2) is applicable to the proposed installation and that no further NEPA documentation is necessary.
- (b) **ESA Documentation** – WSDOT must ensure that utility installations requiring FHWA approval will not have adverse effects on species protected under ESA. If WSDOT verifies that no effects to listed species would result from the proposed installation, WSDOT must issue a "no effect" letter to FHWA for documentation. If, however, an ESA listed species may be present in the vicinity of the installation, further documentation related to the likelihood that the installation would affect the species is required. Contact the region Environmental Office for more information on ESA documentation.
- (c) **NHPA Section 106** – WSDOT and FHWA have entered into a statewide programmatic agreement that establishes stipulations for National Historic Preservation Act compliance for WSDOT highway projects. Under Exhibit B, Section B-12, of this agreement, "Trenching or other excavation to install, replace, or repair electrical, water, sewer lines, fiber optics, telephone cable, or other utilities in areas demonstrated to have been previously disturbed by construction, fill, or prior trenching activities" is presumed to have minimal potential to cause effects, pending additional screening, in order to determine that further review or documentation under NHPA is not required.

If utility installations requiring FHWA approval are consistent with B-12, the programmatic agreement requires that the qualified WSDOT cultural resource specialist conduct the additional screening to make and issue such a determination, and issue a statement to FHWA that Section B-12 of the Section 106 programmatic agreement is applicable to the proposed installation, and that no further NHPA documentation is necessary. If, however, the screening indicates that the proposed installation does not meet the conditions of Exhibit B, Section B, further review and documentation may be necessary. Contact the region Environmental Office for more information on NHPA Section 106 documentation.

120.13 Utility Maintenance

WAC 468-34-340(2)(B)

All utilities installed within the highway operating right of way shall be maintained in good condition operationally and visually. Utilities requiring routine maintenance or inspection shall notify WSDOT and receive approval before any work is performed.

(1) Utility Maintenance Requirements

At a minimum, utility maintenance proposals must include:

- Contractor name and contact (if different from utility owner of record).
- Type of maintenance required.
- When work will be performed.
- Location of work (state route and milepost).
- Accommodation document's number authorizing existing facilities.
- Traffic control.

Other items to consider include:

- Plan view drawing and/or cross section.
- Ingress and egress points.
- Number and type of equipment needed for maintenance operations.
- Staging areas for equipment and materials, if applicable.

(2) Notification of Maintenance Operations Within State Right of Way

Utilities shall submit a Notification of Maintenance Operations Within State Right of Way to the region Utilities Office within three (3) working days prior to any maintenance work. Some highway locations may require that specific information be submitted for approval.

Utilities installed within limited access may require that more detailed information be submitted.

WAC 468-34-340(2)(C)

- (a) **Emergency Repair** – The need for emergency repair of a utility must be communicated to WSDOT immediately and approval as to the manner of repair secured as soon as possible.

In all cases, the safety and protection of the traveling public is the prime concern of WSDOT and the utility. All traffic control shall conform to the current issue of the *Manual on Uniform Traffic Control Devices* (MUTCD).

120.14 Variances: Types, Treatment, and Approval

A variance is a proposed utility installation that is contrary to the *Utilities Accommodation Policy* established by WSDOT. All variations from department policy require written justification from the utility for review and appropriate approval. WSDOT shall avoid approving variance proposals that are insufficiently justified.

By definition, variances have the potential to negatively affect the continued operation of the highway. Therefore, review in detail variance proposals and their impact on highway facilities both during construction and in the future.

(1) Variance Documentation

Best Practice

The variance approval process must be thoroughly documented in the application file. This documentation may be required at a future date to illustrate the variance approval decision process in the event of a tort claim or other litigation involving the utility installation. (See 100.05, Accommodation Documents: Management and Administration, for detailed guidance on file maintenance best practices.)

(2) Types of Variances

Items considered a variance to WSDOT's *Utilities Accommodation Policy* include:

- Open cuts of state roadway.
- Open trenches within areas defined as Category 1.
- Shallow depth installations that do not meet the requirements of [WAC 468-34-200](#).
- Longitudinal installations inside limited access control right of way.
- Longitudinal installations within any median.
- Aerial installations within Scenic Class A or B.
- Uncased crossings that do not meet the requirements of [WAC 468-34-210](#).
- Control Zone Location I and II aboveground objects.

A single utility installation may include more than one of the variances listed. Regardless of the number of variances proposed for a single utility installation, document each variance completely, as described in this section.

(3) Justification Requirements: General

The approval of any variance installation proposal must meet four criteria. The utility owner or its representative must provide sufficient information to prove that the proposed variance is:

- Reasonable
- Verifiable
- Valid
- Justified

The proposal must be **reasonable** and within the bounds of normal industry standards. There must be a **valid** reason the variance is necessary, and it should not place the convenience of the utility ahead of the needs or goals of WSDOT. Issues or circumstances cited as reasons for the variance must be able to be **verified** by documentation. The proposed variance must also be **justifiable** as the only available means of installing the proposed utility based on all other alternatives considered but rejected.

To begin the variance approval process, utilities must complete a variance justification package for review by WSDOT. It is the responsibility of the utility to provide proof sufficient for approval by the department.

In addition to the general application requirements listed below, include the following specific information for each type of variance proposal:

- Engineering plans, profiles, and details for the chosen route.
- Roadway cross section of the entire right of way width at regular intervals (maximum 50 feet) where the open trench encroaches upon the roadway prism. Show details relating to width of travel lanes; turn lanes; shoulders and widened areas; and location of existing utilities.
- Open trench cross section showing pipe and casing, if applicable; trench width; pipe zone bedding and material; backfill material; and existing and replacement surfacing material, width, depth, and specifications.
- Utility Maintenance Plan, if necessary.
- Cost estimate, if cost is the reason for the rejection of alternatives.
- Additional supporting information.

WAC 468-34-190(4)

- (a) **Open Cuts of State Roadways** – Open cutting the paved surface of a highway allows intrusion by weather, settling due to poor material or compactive efforts, and other factors that lead to premature roadway deterioration. These and other causes can result in an overall increase in roadway maintenance, snow-removal difficulties, and other cost-prohibitive challenges for WSDOT. It is for these reasons the department considers **any** open cutting of the paved roadway a variance from policy and requires extensive justification for approval of any open cut proposal.

All applications proposing to open cut the paved roadway shall include:

- Open Cut Variance Request Justification (see [Appendix B](#)).
- Plan showing all alternative routes considered.

WAC 468-34-190(3)

- (b) **Open Trench Within Limits of Category 1** – Open trenching includes both longitudinal trenching for utility installation and trenching related to work such as a bore pit. Similar to open cutting, open trenches near the edge of pavement reduce the life span of the roadway structure, can cause undermining of the paved roadway and lead to settling, and have other negative impacts. Because of such issues, these conditions are a variance from policy and require justification for approval of any open trench proposal.

All applications proposing open trenching within the limits of Category 1 must include:

- Roadway Prism Open Trench Variance Request Justification (see [Appendix B](#)).
- Plan showing all alternative routes considered.

WAC 468-34-200

- (c) **Shallow Depth Installation** – Utilities must be installed at depths noted in [Figure 120-3](#), Minimum Cover Detail, to protect the utility from damage to superimposed highway loads and maintenance operations and to avoid impacts to the utility by minor highway improvement projects.

Shallow installation proposals shall include suitable reinforcement to protect the utility from loading and highway operations. (See [120.15](#), Casing, Conduit, Innerduct, and Encasement, for additional guidance on pipeline protection and reinforcement.)

All proposed shallow depth utility installation variance proposals must include:

- Shallow Depth Installation Variance Request Justification (see [Appendix B](#)).
- Reinforcement detail showing the type of protective measures proposed and construction methods.

WAC 468-34-190(3)

- (d) **Longitudinal Installations Within Any Median** – All longitudinal median installations are a variance from WSDOT policy and must be justified. Median installations present construction challenges for the utility; hazards for the traveling public from construction equipment and materials; safety issues for construction workers; highway improvement relocation issues for the utility; and potential for construction delays on department highway improvement projects.

All applications proposing a utility installation in a median must include:

- Longitudinal Median Installation Variance Request Justification (see [Appendix B](#)).

- (e) **Longitudinal Installations Within a Limited Access Controlled Highway** – WSDOT and the FHWA purchase access rights to some highway rights of way in order to limit access to the facility. Full access control facilities access transportation facilities only from interchanges.

See AASHTO's "A Policy on the Accommodation of Utilities Within Freeway Right-of-Way"

- Access to worksites from interchange ramps or to areas outside the designated main line traveled way is also restricted.
- Any access from outside the right of way or to locations beyond interchange ramps or main line traveled lanes must be justified.

To determine the limited access level of specific rights of way, refer to the Access Control Tracking System managed by the Access and Hearings Section of the HQ Design Office.

All applications proposing an installation anywhere within limited access or that require access to or from limited access right of way must include:

- Limited Access/Encroachment Variance Request Justification (see [Appendix B](#)).

- (f) **Aerial Installation Within Scenic Class A or B** – The Scenic Classification Policy exists to preserve scenic vistas along or over state highways, and it applies to any aerial or surface utility. Scenic classification does not apply to subsurface utilities.

Generally, installations proposing to install aerial facilities within Scenic Class A or B are a variance to WSDOT policy and require reasonable justification. At its option, the department may allow aerial facilities proposed within Scenic Class AX or BX if acceptable mitigation measures are applied. (See [120.08](#), Scenic Classification Policy, for guidance on scenic classes.)

All applications proposing an aerial facility within Scenic Class A or B must include:

- Scenic Classification Variance Request Justification (see [Appendix B](#)).

- (g) **Control Zone Location I and II Utility Objects** – Locate all utility objects outside the Control Zone in order to maintain a highway free from objects that may be struck by errant vehicles. Installations that are proposed to be installed inside the Control Zone (Location I or II) must be supported by sufficient justification for variance consideration. (See [Chapter 9](#), Control Zone, for detailed information on Control Zone requirements.)

All applications proposing the installation of a Location I or II aboveground utility object must include:

- Control Zone Location I and II Variance Request Justification (see [Appendix B](#)).
- Utility Object Relocation Record (see [Appendix B](#)).

(4) Variance Justification Review

Justification packages are sent to be reviewed and approved by the appropriate region and Headquarters specialty groups. Conditions and situations vary from installation to installation. Specialty groups that may need to be involved in variance reviews include, but are not limited to, the following:

- | | |
|-------------------------------|-----------------------------------|
| • Area maintenance personnel | • HQ or region Hydraulics Office |
| • Region Environmental Office | • HQ Bridge and Structures Office |
| • Region Traffic Office | • HQ Geotechnical Division |
| • Region project offices | • HQ Access and Hearings Section |
| • Region Development Services | • FHWA |
| • HQ or region Materials Lab | • Survey Support Unit |

Best Practice

(5) Variance Approval

Certain variances are delegated to the Regional Administrators for approval; others require the approval of the HQ Utilities, Railroad, and Agreements Manager after concurrence by FHWA. (See 100.06, Approval Authority, for a specific list of delegated approvals, and Figure 100-8 for general guidance and a flowchart outlining the process.)

Each region should develop a system for the processing of region-delegated variance approvals.

(a) **Headquarters Approval Transmittals** – Variance approval requests should be prepared for signature and forwarded to HQ Utilities. Contact Headquarters early in the approval process. A preliminary submittal is recommended for review, comments, and any additional information needed. As such, all Variance Request packages must contain a completed Justification.

1. **Application Package** – All variance approval requests transmitted for Headquarters approval must contain:

- An Utility Accommodation Application with the utility's signature.
- Special Provisions for permits and franchises.
- Utility Facility Description.
- Appropriate permit or franchise exhibits.
- Approved Traffic Control Plan, if required.
- Approved TESC Plans, if required.
- Approved Dewatering Plan, if required.

2. **Variance Request Package** – A memorandum providing the following information must be attached as a cover to the Variance Request Package.

- Description of the variance with a reference to the appropriate part of the Utilities Accommodation Policy for which a variance is being requested.
- Highway classification.
- Region review effort, comments, and support.
- Justification.
- Access type.
- Scenic classification.
- ADTs.
- Method of construction and maintenance access.
- Maintenance Plan (if appropriate).
- Bridge data (if appropriate).
- Other pertinent information that may have a bearing on approving authority's signature.

120.15 Casing, Conduit, Innerduct, and Encasement

(1) General Requirements and Considerations

Encasement or casing of utilities within the roadway prism is necessary for a variety of reasons, including constructibility, code requirements, or other situations. When considering utility installations within the right of way, WSDOT's review should not focus strictly on the immediate construction impacts of the installation, such as with open cuts. Attention should also be paid to the preservation of the roadway and the long-term effects the proposed utility may have upon continued operation, maintenance, and improvement of the highway. Issues to consider include:

- Pressurized pipe rupture or leaking.
- Leaking of hazardous, caustic, or combustible materials.
- Utility maintenance or improvements that may require removal or replacement of carrier pipe or conduit.
- Utility relocation.

All pipeline installations shall meet the requirements outlined in this section. Any application for utility accommodation proposing to install a utility without casing as defined under [Required Casing Conditions](#) (below) is a variance to WSDOT policy. (See Section [120.14](#), Variances: Types, Treatment, and Approval, for detailed guidance on justification procedures.)

(2) Required Casing Conditions

Casing of utilities is required for the following situations and conditions:

- Utilities installed under completed limited access highways or freeways. Casing shall extend from right of way line to right of way line on all access controlled rights of way.
- Utility crossings where casing is required by appropriate industry code or special conditions.
- Pressurized carrier pipe installed within the roadway prism, including pipe installed longitudinally under the roadway.
- Pipelines carrying transmittants that are flammable, corrosive, expansive, energized, or unstable.
- Utility installations where local features, embankment materials, construction methods, or other conditions indicate any possibility of damage to the protective coating of carrier pipe during installation. It is the responsibility of the utility to provide evidence that the pipe coating will not be damaged during installation.
- Installations at locations such as freeways or other high-volume or controlled access highways where the current or future insertion, removal, replacement, or maintenance of utilities would avoid open trench construction.
- Protection of the utility from external loads or shocks both during and/or after construction.
- As a method of conveying leaking fluids or gasses away from the area directly under the roadway to a point of release at or near the right of way line or to an established highway drainage containment facility.

WAC 468-34-210

WAC 468-34-210

WAC 468-34-210
WAC 468-34-210(3)(a)
and (b)

WAC 468-34-210
WAC 468-34-210(1)(a)
AASHTO
WAC 468-34-210(1)(b)
WAC 468-34-210(1)(c)
WAC 468-34-210(1)(d)
WAC 468-34-210(2)(a)
WAC 468-34-210(2)(b)
WAC 468-34-210(2)(c)
WAC 468-34-210(2)(d)

WAC 468-34-100
WAC 468-34-210(3)
WAC 468-34-210(3)(a)

- (a) **Exceptions to Required Casing Conditions** – Casing is required for all conditions defined by this section. Except as outlined below, no exceptions to casing requirements should be allowed for utility installations that might otherwise be installed using open trench construction methods or in advance of highway construction. All utility installations that require encasement but are proposed to be installed without encasement must be justified as defined by this manual. (See 120.14, Variances: Types, Treatment, and Approval, for additional guidance regarding variance justification.)

WAC 468-34-210(3)(c)
WAC 468-34-210(3)(b)

The exceptions to casing are as follows:

- Uncased crossings for local service connections of 1-inch-diameter or less carrying natural or other gas across two-lane highways may be installed without casing.
- Pipelines conveying natural or other gas that meet the design, installation, and cathodic protection provisions of the Minimum Federal Safety Standards, 49 CFR, Part 192, and WAC 480-93, Gas companies – safety.

(3) Longitudinal Casing Installation

WAC 468-34-190

Longitudinal installations are typically not subject to casing requirements. In all cases, WSDOT should work with the utility to find alternative installation locations within the right of way that will avoid the need for longitudinal installations.

(4) Encasement Requirements: Materials and Construction

WAC 468-34-210(4)

- (a) **Crossing Length** – Casing shall extend a minimum of 6 feet beyond the edge of the roadway prism or back of curb (see Figure 120-9, Rural Casing Installation, and Figure 120-10, Urban Casing Installation).

WAC 468-34-210(5)
WAC 468-34-250(3)(c)

- (b) **Seals and Annular Fill** – Casings shall be sealed at both ends. Casings over 12 inches in diameter shall have the annular spaces between carrier pipe and the casings filled with pressurized grout or blown sand unless otherwise authorized by WSDOT.

WAC 468-34-220(1)

- (c) **Vents** – Vents are required for all casings holding carrier pipe transmitting fuel where required by 49 CFR, Part 192, Minimum Federal Safety Standards. Vents shall be located as close to the right of way line as possible and free from vegetated cover.

WAC 468-34-220(2)

- (d) **Drains** – Drains are required for all casings holding carrier pipes that contain liquid, liquid gas, heavy gas, or other petroleum products. Drains should outfall to locations approved by WSDOT and where, if a rupture in the carrier pipe were to occur, it would not cause harm or damage to environmentally sensitive areas. Under no circumstances shall the drain or drain outfall be used as a wasteway for purging the carrier pipe unless specifically authorized by WSDOT.

WAC 468-34-210

- (e) **Installations on Highway Structures** – Encasements within, upon, or near any highway structure require the advance review and approval of the region Bridge Maintenance Office, HQ Bridge Preservation, or HQ Bridge and Structures Office. (See 120.07, Bridges and Structures, for detailed guidance on structure attachments.)

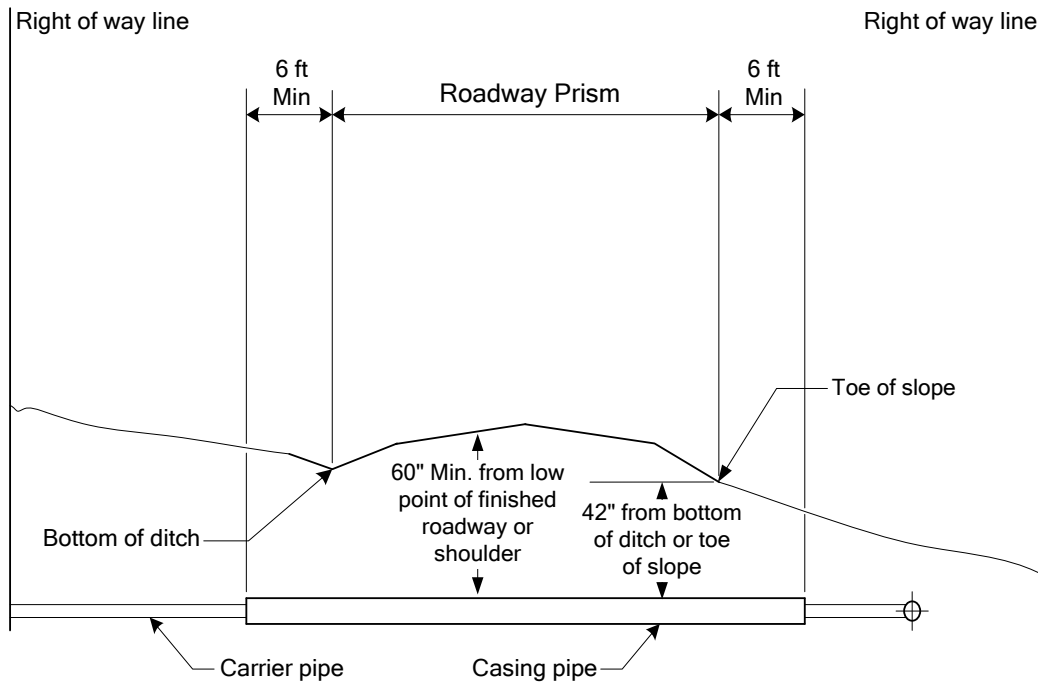

Rural Casing Installation
Figure 120-9

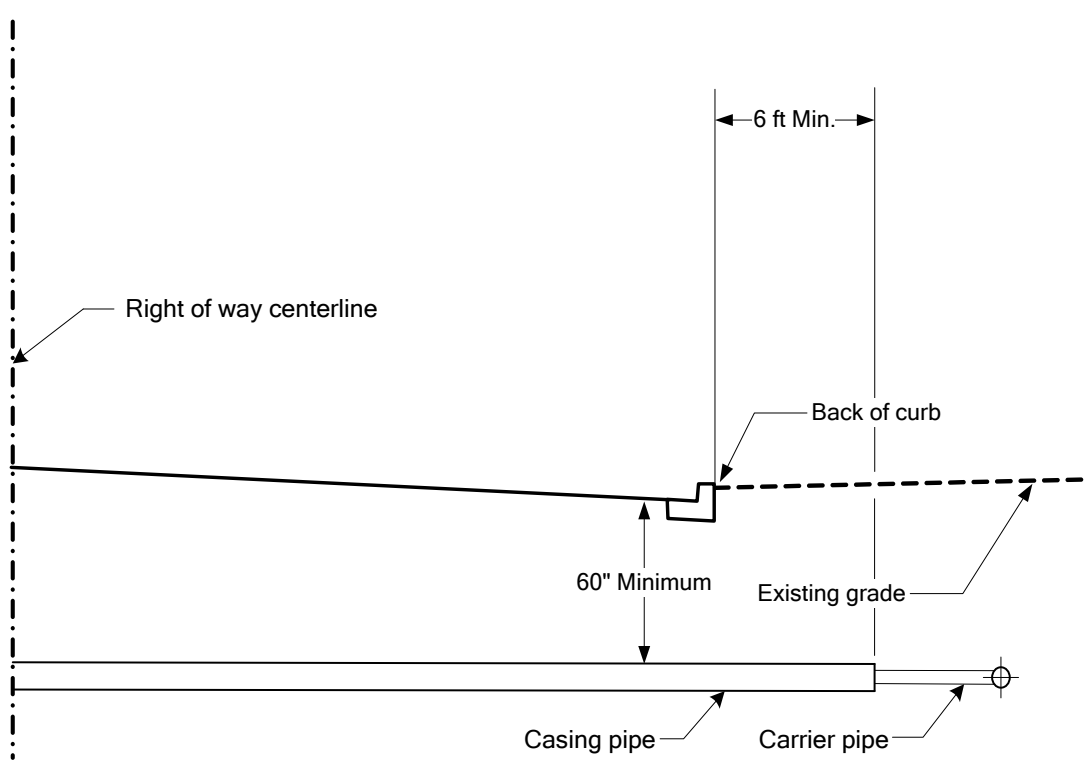

Urban Casing Installation
Figure 120-10

130 Post-Approval Administration

130.01 Addenda to Approved Accommodation Documents

An addendum is any document or plan that revises, modifies, or supplements a previously approved utility accommodation document, becoming part of the approved utility installation.

Minor changes to previously approved utility accommodation documents often make resubmitting the entire permit or franchise application costly and impractical. An addendum allows the focused review of a minor change or addition to the approved permit or franchise and could avert the need to submit an entirely new application.

Note: Addenda should be used only prior to or during construction. Minor post-construction changes should be noted on as-builts.

(1) When to Use an Addendum

Addenda should be used when a revision to an approved permit or franchise is necessary, but submitting a complete new application is not practical. Examples of when an addendum may be an alternative to resubmitting the entire utility installation proposal for another review include:

- Revision to a Special Provision, such as a change in WSDOT's contact person, addition or modification to a provision, or correction of an error or omission.
- Changes in the location or scope of work that do not change the details of the overall approved installation.
- Changes in size, capacity, or quantity of the utility being installed.
- Changes, additions, or revisions to an exhibit such as the Traffic Control Plan (TCP), Temporary Erosion and Sediment Control (TESC) Plan, or other preapproved exhibit.
- Change in construction method(s).

Circumstances may warrant the use of a method other than an addendum to remedy a given situation. Consider each addendum separately based on the risk of the proposed change. Documentation may range from a simple letter approval or red-line correction for a low-risk revision, to complete addenda documentation. A new application may be the best solution for a higher level of risk. Check with the approving authority for guidance.

(2) When Not to Use an Addendum

Significant changes in the originally approved application will usually require submitting an entirely new application for complete review approval. Some examples where an addendum may not be appropriate include, but are not limited to:

- Impacts occur to a highway structure.
- Changes where a new approval process must be completed.
- Changes impact the access level of the highway where the utility is being installed.
- Changes impact a highway project.
- Due to the proposed addendum, the approval level authority changes to a higher approval authority from that of the originally approved accommodation document.
- Producing the addendum will require more work or expense to approve than submitting a new application.

(3) Approval

An addendum or other change to the originally approved accommodation document should be approved by the original approving authority. (See 100.06, Approval Authority, for additional guidance.)

(4) Components of an Addendum

It is important to maintain a record of addendum approvals. Records of addenda may consist of an e-mail or a simple addendum approval letter, to a complete set of formal addendum documents (see sample in Figure 130-1). Under no circumstances should verbal authorizations be considered an appropriate method of revising an approved accommodation document.

(a) **Formal Addendum Documentation** – A complete set of formal addendum documents should consist of:

- A cover letter with instructions to the permit or franchise holder explaining the addendum procedure.
- Addendum documentation (see sample in Figure 130-1).
- Addendum receipt (see sample in Figure 130-2).

(5) Confirmation Receipt

A confirmation receipt may be required for revisions or changes to approved documents. The receipt should include language that legally confirms or endorses the change. The need for a receipt should be considered depending on the significance of the change. The approving authority is the decision maker regarding the need for a confirmation receipt. (See Figure 130-2 for a sample receipt.)

(6) Procedure

The recommended procedure for processing changes or revisions to an approved accommodation document is as follows:

- Identify the item or issue that requires a revision or addition. Verify that an addendum to the original document is the appropriate method of amending the issue.
- If appropriate, initiate any necessary reviews.
- Process changes to permit or franchise documentation as needed.
- Obtain approval for the revisions or additions from the approving authority.
- Forward the addendum package to the utility owner with receipt confirmation, if needed.
- Once addendum receipt confirmation is received, forward a copy of the signed addendum to the region Utilities Inspector. File the original addendum documentation in the accommodation document file.
- Forward a copy of any revisions, additions, or new approved applications to the original accommodation document recipients.
- File the original addenda documentation in the region accommodation file.

Department of Transportation
Olympic Region Utilities Office, Olympia, WA 98504

**UTILITY FRANCHISE AMENDMENT NO. 6123, Amendment 12
SR 88, Milepost 35.56 to Milepost 41.02**

ADDENDUM NO. 1

The General Provisions, Special Provisions, and Exhibits for this utility permit or franchise are amended as follows:

General Provisions

The following is added to item 16:

Costs incurred by the Department shall be billed to existing Jx Account No. 1234. Any and all costs and impacts incurred by the State to restore the project site to State contract 4321 specifications due to work performed under this franchise will be the responsibility of the utility.

Special Provisions

Exhibit A

On page 1, the following Department representative is revised to read:

*John Engineer, P.E.
5720 Capitol Blvd.
Tumwater, WA 98504
(360) 555-1212
E-mail: enginej@wsdot.wa.gov*

On page 1 the following is added:

Item 9 is hereby added as an applicable provision.

On page 3 the following is added:

42. As agreed in the August 14, 2008 field meeting between the Department and the Utility, the Utility shall coordinate its work with the Department representative noted in Special Provision 1. It was agreed that the Utility will use the Department's contractor to reestablish any disturbed vegetation, landscaping, or planting previously completed by the Department and its contractors or subcontractors.

Page 1 of 1

**Addendum Document
Figure 130-1**



**Washington State
Department of Transportation**

Paula J. Hammond, P.E.
Secretary of Transportation

Transportation Building
310 Maple Park Avenue S.E.
P.O. Box 47300
Olympia, WA 98504-7300
360-705-7000
TTY: 1-800-833-6388
www.wsdot.wa.gov

ADDENDUM RECEIPT

**UTILITY FRANCHISE NO. 10028 C AM 5
SR 123, Milepost 5.76 to Milepost 5.78**

Addendum No. 1

By my signature, I hereby acknowledge that I am authorized by my company or organization to approve the above utility permit or franchise addendum and concur with the revisions contained therein.

Signed and dated this _____ day of _____, 20 ____.

Sign name

Print or type name

Print or type title

Print or type company name

Print or type company address

Print or type City, State, Zip Code

Addendum documentation must accompany other utility permit or franchise documentation on the jobsite and is not effective until received by the Department. Please sign and return this page by mail, e-mail, or return fax.

Addendum Receipt
Figure 130-2

130.02 Extension of Installation Time

By signing the Utility Accommodation Application, applicants agree to begin construction within one year from the date of approval of their application. Utility accommodation documents will be considered invalid if construction does not begin within the time frame indicated on the application. When this occurs, or if construction cannot be started within the one-year time frame, the utility must either apply for an Extension of Installation Time or reapply for a new accommodation document.

WSDOT Policy

(1) Purpose

The primary purpose of this time constraint is to ensure no changes have occurred in the scope of the installation or the method of construction from that originally approved. WSDOT should review the original documents to ensure no changes have occurred.

(2) Requests for Extension of Time

If construction has not begun within the one-year time frame, as determined by the application approval the applicant should (1) submit a written request for an extension of time to begin construction or (2) submit a new application. The request should include justification for the delay in construction start. WSDOT should review the request and make a reasonable effort to verify that no significant changes have been made in the scope or nature of the installation.

- (a) **Cost Recovery** – If construction for an approved accommodation document has not occurred, the cost-recovery policies apply to the request for the extension of time. In the event additional reviews are warranted, accommodation cost-recovery policies may be instituted for the review costs necessary to acquire approval of the request.
- (b) **Requirements for Extension of Time to Begin Construction** – For applications previously approved, but for which construction has not begun within the one-year period after the approval date, all of the following should be submitted or apply:
 - Written justification for the delay in construction start.
 - If changes have occurred, new plans for approval, along with application to be treated as a completely new submittal.
 - Approval should be by the original permit or franchise signatory or equal.

Additionally, items that should be considered on a case-by-case basis when an Extension of Installation Time request is received include:

- Meeting with applicant and WSDOT support personnel, as appropriate.
- Establishment of a reimbursable account may be necessary for the additional review and/or meetings required, if the applicant does not have an active reimbursable account.
- Reevaluation of existing Traffic Control Plans or new plans, as may be needed for revised installation plans.
- Review and approval by appropriate support groups.

130.03 As-Builts: Record Drawings

As-builts (or Record Drawings) are plans showing the actual installation location of the utility after necessary field adjustments.

Whenever there is an approved field change to the accommodation document, an As-Built shall be submitted to WSDOT within 90 days after the completion of the installation.

As-Built documents shall be submitted by the utility owner or its authorized agent, unless the WSDOT inspector documents the changes. These changes should be noted in the original accommodation document and in the Utility Franchise and Permit (UFP) database.

Changes to the proposed installation shall be submitted on new plan sheets or on existing plan sheets, with *additional* installations in red and *deleted* items in green.

Upon receipt of as-builts, make the appropriate changes in the UFP and the original accommodation document. New copies of the changes shall be sent to the original recipients.

130.04 Penalties

RCW 47.44.060

All persons, firms, or corporations that construct, operate, or maintain a utility or similar facility must first have, and have at all times and in full force and effect, a utility franchise or permit in the manner provided by law. Those found in violation of the law are guilty of a misdemeanor and may be liable for a civil penalty of \$100 per calendar day from the date notice is given.

Accommodation issues that need to be considered for penalties include, but are not limited to:

- Expired franchises.
- Utilities inherited by a Route Jurisdiction Transfer.
- Issues resulting from impacts from a highway improvement project.
- A breach of the terms of the approved utility permit or franchise.

(1) Notification and Department Action

Prior to attempting to formally collect any penalties, a three-step notification process must be followed:

- Step 1** – Make every effort to work in an informal, cooperative manner with utility owners to resolve issues for which penalties may be under consideration. Document all formal and informal contact with the utility while attempting to resolve the penalty issue.
- Step 2** – Send a certified letter to the utility per [RCW 47.44.060](#). The notice must inform the utility owner that an [Utility Accommodation Application](#) must be submitted within 45 days or the utility installation must be removed from the right of way. The letter must indicate the location of the utility within the right of way.
- Step 3** – If no application has been received from the utility owner within 45 days, contact [HQ Utilities](#). [HQ Utilities](#) will meet with the Attorney General's Office to discuss the next step that may need to be taken.

The utility owner has 45 calendar days from the date of receipt of the certified letter to apply for an accommodation document and comply with WSDOT's [Utilities Accommodation Policy](#).

130.05 Utility Transfer of Ownership – Acceptance of Assignment

One of the key objectives of the utility accommodation process is to maintain accurate records of the type, capacity, location, and ownership of each utility located in the operating highway right of way. The Utility Transfer of Ownership process was created to document the ownership changes of existing utilities. Ownership changes have an effect on sureties, Franchise Renewals, and data management and administration. These areas should be taken into account when utility ownership transfers occur.

WAC 468-34-020(1)

(1) **Benefits of Documenting Ownership Transfer**

Accurate records benefit WSDOT by allowing the Region Utilities Engineers to contact utility owners in the event utility relocation is necessary to accommodate a highway improvement project.

(2) **Transfer Requirements**

The Utility Transfer of Ownership process is required whenever an existing utility:

- Transfers ownership
- Changes its name
- Makes a change in corporate structure

(3) **Coordination and Responsibility**

The lead for the Utility Transfer of Ownership process varies depending on the utility and the circumstances.

- (a) **Region-Only Transfers** – Region Utilities offices should maintain a recordkeeping system that tracks individual accommodation document assignments for utilities that are restricted to within region boundaries, where the change in ownership will not affect other regions' business needs.
- (b) **Statewide Transfers** – Utility Transfers of Ownership for utilities that cross region boundaries should be coordinated by HQ Utilities. This ensures statewide involvement in the transfer process and allows for coordination and communication of ownership and blanket surety issues.

(4) **Effect on Accommodation Documents**

There are secondary effects to accommodation documents when there is an ownership transfer. Those effects depend on the type of accommodation document, its status, and the location of the utility. (See [100.05](#), Accommodation Documents: Management and Administration, and [100.02](#), Types of Utility Accommodation Documents, for additional guidance on accommodation documents.)

- (a) **Current Utility Franchises** – The ownership transfer process should not have an immediate effect upon current unexpired utility franchises. However, when franchises are involved in utility transfers of ownership, several issues must be confirmed and, if necessary, communicated to the new utility owner to ensure full disclosure of pending issues that will affect the utility.
 1. **Utility Franchise Expiration Date** – Utility franchise expiration dates carry over to the new utility owner in the Utility Transfer of Ownership process. There is no change or adjustment in the franchise expiration date. It is important that WSDOT advise the company assuming utility ownership responsibility of any pending franchise expiration issues that will require Franchise Renewal.

2. **Transfer of Aerial Franchises in Scenic Class A or B** – Similar to notification of pending or currently expired franchises, it is critical to disclose to the company assuming utility ownership any existing or pending franchise expirations that will require an aerial facility to be removed and installed underground on highways within Scenic Class A or B. (See [120.08](#), Scenic Classification Policy, for additional guidance on scenic classification issues.)
 - (b) **Transfer of Expired Franchises** – Expired franchises are not legal documents; they have expired and are therefore not eligible for transfer from one entity to another. Before any transfer can legally take place, the original owner must renew the franchise, or the new owner must apply for a new utility accommodation application or Consolidation.
 - (c) **Utility Permits** – Utility permits are by nature perpetual documents. There should be little administrative effect to utility permits due to an ownership transfer. Surety issues and database name changes must be addressed.

(5) Effect(s) on Surety

Blanket sureties held by WSDOT insuring the previous utility owner should not be released until the ownership transfer process is complete. If the previous utility has installations pending release of surety, a new surety must be obtained by the new utility until the utility installations are eligible for release from surety. If the new utility plans to make additional applications for utility installations, the utility should be encouraged to obtain a blanket surety. However, the new utility also has the option of obtaining individual sureties for new utility installations. (See [110.04](#), Sureties, for additional guidance.)

Utility Transfers of Ownership for companies holding a blanket surety must be coordinated with [HQ Utilities](#) to ensure the existing blanket surety for the outgoing utility owner is released and replaced by an appropriate surety for the new utility owner.

(6) Document Administration

Use of a single Utility Transfer of Ownership form with an attached list of affected accommodation documents may be used to document the ownership transfer. A single form for each document being transferred is also acceptable. Regardless of the method, the Utility Transfer of Ownership form must list each accommodation document affected by the transfer. Regions should ensure each permit or franchise involved in the transfer has a copy of the Utility Transfer of Ownership form placed in each accommodation document file.

- (a) **Utilities Database** – Updates to the UFP database relating to transfer of ownership are the responsibility of [HQ Utilities](#). Contact Headquarters when changes need to be made to the database holder table, whether the transfer is region-specific or being done statewide.
- (b) **Filing: Region** – Regional transfers of ownership should be maintained at the region Utilities Office. An appropriate file or data system should be maintained to track the changes in ownership of various utilities within the region.
- (c) **Filing: Statewide** – [HQ Utilities](#) maintains a file or data system of statewide transfers of ownership as well as a database that tracks the historical changes in ownership of various utilities across the state.

(7) Utility Transfer of Ownership Form

Use a Utility Transfer of Ownership (Acceptance of Assignment 224-051 EF) form when transferring ownership of utilities between entities.

130.06 Abandoned, Deactivated, or Disconnected Utilities

Discovery of abandoned, deactivated, or disconnected utilities often results in project delays during highway improvement projects or maintenance activities. There is also a safety issue when locating underground utilities near other active utility lines. Whenever possible, the first goal should be to completely remove any utility facility no longer required by the utility owner, at the owner's expense.

When utility removal is infeasible, take appropriate steps to document and secure the abandoned, deactivated, or disconnected utility's status and ownership. Maintain an accommodation document on file to document the location, ownership, and status of abandoned, deactivated, or disconnected in-place utilities. (See 120.04, Pipelines, for guidance on abandoning pipes and casings.)

Certain utilities (such as pipes or casings) that are abandoned, deactivated, or disconnected but are not removed may offer opportunities for future utility installations without the need to install additional ducting or casings. Consideration should be given to the safety of the public, the condition of the existing utility, compliance with current standards, and other issues that may be evident.

If feasible, completely remove direct buried utility company facilities such as telecommunication lines, unless the facility lies under an existing roadway or environmentally or culturally sensitive land. If WSDOT has a need for such facilities and would benefit from acquiring ownership of such, then there may be a purpose for keeping the facilities in place.

(1) Removal of Hazardous Materials

Utility facilities that may have transported hazardous materials, or any utilities composed of hazardous materials, must be considered for removal, at the owner's expense, at the time of abandonment. Removal may also be delayed until some future time, as approved by WSDOT. Avoid placing the department in a position where it may need to pay for the future cost of removal and disposal of hazardous materials or contaminants.

(2) Options

Utilities that wish to abandon, deactivate, or disconnect utilities in place and avoid removal costs may do so, but only under specific circumstances. Facilities that are abandoned, deactivated, or disconnected in place remain the property and responsibility of the utility owner unless the owner wishes to transfer ownership to WSDOT and the department agrees.

- (a) **Ownership Maintained by Utility** – Utilities that wish to keep ownership of deactivated or disconnected facilities that have been left within the operating highway right of way must maintain an accommodation document listing the facility as deactivated or disconnected.

Until abandoned, deactivated, or disconnected utilities are either removed or ownership is transferred to another organization, the utility facility remains the responsibility of the utility owner of record.

- (b) **Ownership Transferred to WSDOT** – Utilities that wish to transfer ownership of abandoned facilities to WSDOT may do so, provided the department agrees to the transfer.

Requirements for such transfers are as follows:

- WSDOT must have a clear and present need for the facility.
- The utility agrees to release all future claims to the facility.
- The transfer must be at no cost to WSDOT, as the transfer is for the convenience of the utility.

Contact [HQ Utilities](#) if transfer of ownership is being contemplated by a utility.

(3) Documentation

Ownership of abandoned, deactivated, or disconnected utilities should be documented using a new and/or existing utility accommodation document. A file should be maintained in the region as described in [100.05](#), Accommodation Documents: Management and Administration. A database record should also be maintained listing the utility as “Inactive.”

130.07 Undocumented Utility Installations

RCW 47.44

One of the primary goals of the WSDOT *Utilities Accommodation Policy* is to document location and ownership of utilities. Therefore, it is important to work in a cooperative manner with utility owners to record existing utility installations not already documented by WSDOT. When undocumented utilities are discovered, every effort should be made to work with the utility owner to properly document the existing installation. (See [130.04](#), Penalties, for repeated unauthorized installations.)

(1) Level of Notification

When informing a utility of an undocumented utility installation, it should be assumed that the utility owner desires to comply with the WSDOT *Utilities Accommodation Policy*. Generally a phone call to the utility is sufficient to begin the documentation process and remedy an undocumented installation. Occasionally, additional and more formal notification may be necessary.

- (a) **Initial Notification** – Initial notification to a utility owner should start informally with a phone call or an e-mail. Approach the utility with a collaborative attitude, as formal documentation of utility location and ownership benefits both WSDOT and the utility.

Document all contact, including date, time, contact name, and outcome of the communication with the utility.

- (b) **Additional Notification** – Additional contacts with undocumented utility owners should be progressive in nature, working toward more formal communications as time and level of cooperation from the utility dictates. This may involve additional informal communication or more formal methods (such as return receipt letters) as circumstances dictate, with the end goal of receiving formal application from the utility and subsequent utility location and ownership documentation by WSDOT.

Document all communication with the utility as discussed under [Initial Notification](#) above.

- (c) **Final Notification** – After exhausting all reasonable efforts to obtain compliance from the utility owner, WSDOT shall give final notice by Certified Mail that a franchise or permit is required or the facility must be removed. (See [130.04](#), Penalties, for additional guidance.)

(2) Existing Utilities Installed Contrary to WSDOT Policy

Existing utilities are not exempt from the *Utilities Accommodation Policy*. Documenting existing utilities should include language explaining the circumstances surrounding the installation, such as Route Jurisdiction Transfers.

- (a) **Route Jurisdiction Transfers** – Highways transferred to WSDOT from a local agency will normally include existing utilities. A reasonable effort should be made to document noncompliant utilities, safety issues, and other situations that do not meet current department standards. Future utility or WSDOT projects should correct noncompliant utilities as needed or as defined elsewhere in this manual.
- (b) **Non-Route Jurisdiction Transfers** – Existing utilities installed without prior approval that do not meet department policy should be treated on a case-by-case basis. Undocumented utilities that have been in place for a long period should be documented and, if noncompliant and there is no history of problems, reinstalled or corrected when an opportunity arises, such as during a highway or utility project.

Recently installed undocumented utilities should be handled on a case-by-case basis as well, but with greater scrutiny. If the utility meets WSDOT standards, it may be appropriate to document the installation. Utilities installed that do not meet department standards should be removed and installed correctly, or a variance should be obtained. (See 130.04, Penalties, for additional guidance.)

- (c) **Factors to Consider** – Various elements of the *Utilities Accommodation Policy* must be considered when reviewing how the undocumented utility was installed. For example, utilities must meet Control Zone requirements. If they do not, the facility must be corrected to meet the Control Zone Guidelines.

Subsurface installations must meet depth requirements. For example, if a buried cable installed within a ditch line is shallow enough to be impacted by highway maintenance operations, the utility may be instructed to bury the cable at the required minimum depth or relocate. However, if a buried cable installed near the edge of right of way does not meet depth requirements, the utility may be allowed to remain if determined reasonable by WSDOT. In all cases, document the reasoning and justification for the approval as with any variance justification.

Use individual judgment to determine the best course of action for each situation based on the contents of this manual and its references.

(3) Fees and Cost Recovery

All fees and cost recovery efforts apply to the documentation of existing undocumented utility installations.

WAC 468-34-020(1)

130.08 Turnback Areas and Construction Permits

The types of utility accommodation conditions that require coordination with local agencies are:

- Construction permits
- Turnback areas

Each of these types of construction conditions involves similar coordination efforts with local agencies to ensure the local agency will accept ownership of the utility installation after completion of construction. Because of ownership issues, both types of utility accommodation situations must be treated differently.

(1) Construction Permits

Construction permits are used when a highway project will affect existing local agency right of way. The permit is a temporary right of entry to construct highway improvements. WSDOT has no property rights or utility accommodation approval authority within construction permit areas.

(2) Turnback Areas

Turnback areas are new or existing rights of way belonging to WSDOT that are planned to be transferred to a local agency once highway construction is complete. The department, as fee title owner, has utility accommodation approval and oversight authority for these areas until title to the area is transferred to the local agency. However, to help ensure acceptance of turnback areas after highway construction, any utility installations within the area should be coordinated with the local agency.

Utility accommodation applications located within turnback areas or construction permit areas should be treated differently than utility accommodations within other areas of highway operating right of way, as defined in this section.

- (a) **Coordination With Local Agency** – In all cases, the local agency has an interest in the location and installation of utilities within turnback areas or construction permit areas that are temporarily managed by WSDOT. Approval of all utility accommodation applications within these areas should be coordinated with the local agency, as well as the project construction office administering the project, to avoid construction conflicts between the utility installation and highway construction efforts.

(3) Turnback Process

To ensure turnback areas involving utility accommodation or relocations are accepted by local agencies at the end of the process, every effort should be made to include them in utility accommodation. Refer to the [Agreements Manual](#) for detailed information on the turnback process.

- (a) **Initial Meeting** – An initial meeting should be held to discuss turnback issues.

WSDOT functional areas should include Maintenance, Local Programs, Utilities, Traffic, and others as warranted. Utility owners should also be included in the meetings.

Utility accommodation items that should be considered for discussion in the meeting include:

- Inform the local agency of any utilities that will be turned back to them after the project is complete.
- Discuss local agency utility accommodation standards and ensure utilities are installed or relocated accordingly.
- Review any terms the local agency may want to have included in the accommodation document, such as any Special Provisions, termination clauses, or other language.
- Manage documentation transfer (hard copy or electronic information).

This process will help ensure the local agency will accept any turnback areas that include utilities.

- (b) **Turnback Agreement Language** – Ensure any project Turnback Agreements include a discussion of utilities to be turned over to the local agency.

- (c) **Approval** – WSDOT approval of accommodation documents within turnback areas should not be granted until the local agency has provided written concurrence of the installation.
- (d) **Turnback Area: Transfer to Local Agency** – Approved accommodation documents for utility installations within turnback areas must be sent to the local agency after transfer of ownership. Prior to transfer, the local agency may ask for informational copies of approved accommodation documents. These should be provided if requested.

The region should consider maintaining informational copies of transferred accommodation documents after the transfer is completed. Informational copies may be necessary in the future because of claims issues, future highway projects, or other situations.

(4) **Construction Permit Areas**

- (a) **Construction Permit Area: Utility Accommodation Jurisdiction** – The local agency retains jurisdiction for the processing and approval of accommodation documents within construction permit areas. Approval of proposed utility installations within construction permit areas is the responsibility of the local agency.
- (b) **Construction Coordination** – Because of construction coordination issues, WSDOT has a vested interest in reviewing and concurring with the proposed utility installation if it affects the department’s construction project. The region Utilities Office should work with the local agency to ensure the proposed utility installation is coordinated with the highway project.
- (c) **Postconstruction** – For postconstruction installations where roadway construction is substantially complete but the construction permit remains in effect, the requesting utility should be referred to the local agency for processing and approval of the proposed installation.
- (d) **Approval** – Approval is provided by the local agency.

130.09 Compliance Reviews

In order to reasonably ensure regions are administering the *Utilities Accommodation Policy* consistently statewide and within the guidance provided in this manual, Compliance Reviews will be conducted. HQ Utilities will review each region’s utility permit and franchise approval process at least biannually. The review will involve a representative sample of the regions’ approved permits and franchises, as determined by HQ Utilities.

(1) **Compliance Review Areas**

The following accommodation areas will be reviewed for compliance with this manual and the *Utilities Accommodation Policy*:

- Approval authority
- Application requirements
- Variances from WSDOT policy
- Justification procedures for variances

(2) **Compliance Review Findings**

Findings of inconsistent or procedural deficiencies will be discussed with the region. HQ Utilities and the Region Utilities Engineer will develop a cooperative solution to the findings of the Compliance Review. Any identified improvements relative to processes or standards will be shared with other regions for consideration and possible revision to policy or guidance.

- 200.01 General
- 200.02 Utility Property Rights
- 200.03 Preliminary Engineering Agreements
- 200.04 Construction Agreements

200.01 General

This chapter is intended to be a resource for guidance in processing and administering utility agreements: specifically, Preliminary Engineering Agreements and Construction Agreements. These agreements are typically associated, directly or indirectly, with a transportation improvement project. An agreement is required to define the roles, requirements, and cost responsibilities between the Washington State Department of Transportation (WSDOT) and the utility.

(1) Preliminary Engineering Agreements

Preliminary Engineering (PE) Agreements are normally used when a utility requests reimbursement for preparing a cost estimate and a relocation plan where WSDOT is obligated for all or a portion of the utility relocation costs (see [200.02](#), Utility Property Rights). PE Agreements can also be used by the department to obtain reimbursement for design costs when the utility requests that work be included in a WSDOT contract.

For guidelines, examples, and the approving authority on PE Agreements, see [200.03](#), Preliminary Engineering Agreements.

(2) Construction Agreements

Construction Agreements are the most common agreements and are used for several different types of applications. Examples of when to use this type of agreement include the following:

- When a WSDOT project impacts a utility facility in which the utility has an easement or some type of compensable property interest (see [200.02](#), Utility Property Rights), WSDOT is obligated to pay for its relocation costs and replacement easement and/or fee title property interest. Typically, the utility would perform the removal of its facilities and construct its new facilities within its replacement property. Work would be covered under a Utility Construction Agreement, Work by Utility – State Cost (DOT Form 224-053 EF).
- When a utility requests that WSDOT include construction of the utility’s facilities, such as conduits, water, or sewer lines, as part of a WSDOT project, that work would be covered under a Utility Construction Agreement, Work by State – Utility Cost (DOT Form 224-062 EF). The utility in this case would be responsible for all actual direct and indirect costs, including, but not limited to, WSDOT contract administration, mobilization engineering, and overhead costs.

For guidelines, examples, and the approving authority on Construction Agreements, see [200.04\(1\)](#), Construction Agreement Forms.

(3) Scoping Phase

During the Scoping Phase, specifically on projects requiring new rights of way, the region Utilities Office shall review the project in detail. If utilities are present within the proposed right of way take, there is a good chance a utility agreement and a replacement easement and/or fee title property interest will need to be addressed in the project. Addressing potential agreements early will help build and generate better schedules and estimates.

Early in the Design Phase, each utility shall be notified in writing of the WSDOT project so that it can budget, schedule, and address its relocation needs, and perhaps request to include utility work in the WSDOT project's contract. This will provide WSDOT time to properly schedule and incorporate the agreement work into the project schedule. All utility agreements shall be fully executed prior to contract advertisement.

(4) Definitions

For definitions, see [Appendix A](#), Glossary.

(5) Policies Governing State and Federal-Aid Agreements

[23 Code of Federal Regulations \(CFR\) Part 172](#), Administration of Engineering and Design Related Service Contracts

[23 CFR Part 645](#), Subpart A, Utility Relocations, Adjustments, and Reimbursement

[23 CFR Part 645](#), Subpart B, Accommodation of Utilities

Program Guide: Utility Relocation and Accommodation on Federal-Aid Highway Projects, Federal Highways Administration (FHWA). Regions will inform utilities of the location of this Program Guide: www.fhwa.dot.gov/reports/utilguid/index.htm

Utilities Accommodation Policy M 22-86, WSDOT

For further information, see [Appendix C](#), Policy Guidance.

(6) Applicable State Laws

[Chapter 8.26](#), Revised Code of Washington (RCW), Relocation assistance – real property acquisition policy

[Chapter 47.12 RCW](#), Acquisition and disposition of state highway property

[RCW 47.24.020\(8\)](#), City franchise on city streets that form part of a non-limited access state highway

[Chapter 47.28 RCW](#), Construction and maintenance of highways

[Chapter 47.44 RCW](#), Franchises on state highways

For further legal references, see [Appendix D](#) and the RCW and WAC References.

200.02 Utility Property Rights

The region Utilities Office should work closely with Real Estate Services to ensure all utility property rights issues are addressed as early as possible.

(1) *Compensable Real Property Interest*

A utility is entitled to cost reimbursement for facility relocation and/or adjustment, as well as a replacement property interest, when the utility owns a compensable real property interest. The utility must produce the following to be eligible for cost reimbursement or replacement:

- A deed showing fee title ownership to the property.
- A deed showing easement rights to use the property.
- A court finding of prescriptive easement rights.

A city- or town-owned utility that is located within its street right of way along a nonlimited access state highway within city limits is entitled to utility relocation and/or adjustment cost reimbursement.

Note: Although [RCW 47.44.030](#) provides for a utility cost reimbursement under certain circumstances, all but the first sentence of this statute has been found unconstitutional by the Washington State Supreme Court. Therefore, the utility is only entitled to reimbursement under the conditions listed above.

(2) *Determining Utility Property Rights*

A utility's compensable real property interest must be verified in order to determine whether an agreement is required and to select the proper agreement form.

- (a) **Utilities Located Within WSDOT Right of Way** – The first step in determining utility property rights is to generate a franchise and permit listing for the project from the Utility Franchise and Permit (UFP) database. Where utilities are located within WSDOT right of way by franchise or permit, the cost for any adjustment or relocation will be at the expense of the utility. If the utility or its contractor performs the adjustment or relocation work, a utility agreement should not be required. If the utility would like any portion of the work to be performed by WSDOT or its contractor, a utility agreement will be required.

Adequate accommodation of utilities must be considered during development of a highway project. When determining right of way needs for a highway project, adequate space should be made available to locate utility facilities in a manner that does not interfere with the safe and efficient operation of the highway. To accomplish this goal, WSDOT may acquire the additional right of way necessary to provide a corridor for relocation of utilities.

Not all utilities located within WSDOT right of way have been authorized by a *current* franchise or permit. A utility is illegally located if it does not have a *current* franchise or permit or documented property right. In these cases, the utility must pay all its own costs and apply for a franchise or permit from WSDOT if the utility chooses to remain within the right of way. A utility's application for a franchise or permit and/or to maintain existing facilities within the right of way does not guarantee that WSDOT can issue a franchise or permit for such facilities.

In some instances, utilities are located within WSDOT right of way by easement, or WSDOT may have an easement across property owned by others. If a documented easement exists, it should be shown on the official right of way plan for that section of highway. The cost for any adjustment or relocation will be at WSDOT expense, and a utility agreement will be required. Utilities located within WSDOT right of way by easement are not listed in the UFP database. Utility representatives should provide documentation defining where their facilities are located within an easement. If possible, WSDOT should verify whether the utility-provided easement legal description actually covers the area in which the utility is located, to ensure the utility occupies the claimed easement location. Sometimes, a utility does not occupy a claimed easement location.

On nonlimited access highways within city or town limits, only the city or town has the authority to issue franchises or permits. Therefore, utility facilities located on these rights of way will not show up in the UFP database unless an “informational” permit or franchise has been filed and entered. Typically, when utilities that are not owned by the city are located within the city street/state highway right of way, they have been issued a permit or franchise by the city or town. You should research the city or town records for such franchises or permits. Utility adjustment or relocation should be at the utility’s expense. However, read the city or town franchise and/or permit conditions; if there is a question, seek legal assistance. If a city-owned utility requires adjustment or relocation, WSDOT is responsible for the cost of relocation because the city or town owns the underlying right of way.

- (b) **Utilities Located Outside WSDOT Right of Way** – In order to determine utility property rights outside WSDOT right of way, title reports for each affected parcel must be obtained and reviewed. Review of the title reports should include a search for utility easements. Where utilities hold easement rights on private property, the cost for adjustment or relocation will be at WSDOT’s expense. It may speed up the process during the scoping phase (see 200.01(3)) to request that the utilities produce copies of relevant deeds.

Title reports may not always describe an easement in enough detail. A copy of the actual easement document may be required in order to determine its exact location.

If WSDOT or its contractor performs the adjustment or relocation work when the utility has a documented property interest, reimbursement for the relocation work will not be necessary because WSDOT is responsible for the costs. In this instance, a utility agreement will be required to specify contract terms covering the engineering design, plans, specifications, construction, and acceptance of the utility work. The agreement may include provisions for WSDOT to reimburse utility costs for design review or inspection. If the utility or its contractor performs any portion of the work, a utility agreement will be required because WSDOT is responsible for the costs.

Where utilities are located on their own property by fee title, the property should be identified by its own parcel number on the official right of way plan and a title report obtained for the parcel. In this case the cost of adjustment or relocation of the utility will also be at WSDOT’s expense, including a possible replacement property interest.

Where utilities are located on another public agency's right of way by permit, franchise, or city ordinance, and adjustment or relocation is required by a WSDOT project, the cost of the work is typically at the expense of the utility. However, in order to verify this, a review of the permit, franchise, or city ordinance should be made. If there is a question, seek legal advice.

(3) Compensation and Replacement of Utility Property Rights

A utility is entitled to just compensation for its compensable real property interest when: the utility documents its existing compensable real property interest; facility adjustment or relocation is required by a highway project; or the property interest is taken to the extent that the facility adjustment or relocation cannot be accomplished inside the utility's existing property right. Under these circumstances, WSDOT will follow (a) or (b) below:

- (a) **Compensation** – The first option should be for WSDOT to compensate the utility for its property rights and issue a permit or franchise to authorize the utility to locate within WSDOT right of way. The region Real Estate Services Office will negotiate the compensation to be paid and prepare a quitclaim deed (see Quitclaim Deeds below) for execution by the utility, in conjunction with the region Utilities Office issuing the permit or franchise.
- (b) **Replacement** – If unable to utilize option (a), WSDOT replaces the utility's property rights with the same type of property rights, in accordance with the guidelines listed below.

1. **Utility to Remain Within the Limits of Its Existing Property Rights and Within the New State Right of Way Limits** – The utility conveys its fee title or easement rights within the new highway right of way limits to WSDOT by quitclaim deed. In turn, WSDOT conveys by quitclaim deed a replacement easement to replace all or a portion of property acquired by the WSDOT, subject to appropriate conditions (see Replacement Easements below). If WSDOT replaces a fee title ownership with an easement, the utility may be entitled to some compensation; the region Real Estate Services Office will negotiate the compensation to be paid.

Note: Where the utility's existing property right is an easement, WSDOT still conveys a new easement rather than acquiring the right of way subject to the existing easement. This procedure is recommended so the easement can include language applicable to the new conditions.

2. **Utility to Be Relocated Outside the Limits of Its Existing Property Rights and Outside State Right of Way**
 - **Utility possesses powers of eminent domain** – Utility conveys to WSDOT by quitclaim deed property rights within the new highway right of way limits. WSDOT acquires on behalf of the utility an easement or fee title (as appropriate) and transfers it to the utility, or the utility acquires an easement or fee title (as appropriate) and is reimbursed by WSDOT for the new corridor outside the state's new right of way limits.
 - **Utility does not possess powers of eminent domain** – Utility conveys to WSDOT by quitclaim deed property rights within the new highway right of way limits. WSDOT acquires additional right of way and

thereafter conveys an easement to the utility located within the state's new right of way. If WSDOT replaces a fee title ownership with an easement, the utility may be entitled to some compensation; the region Real Estate Services Office will negotiate the compensation to be paid.

Note: Where the utility's existing property right is an easement, WSDOT still conveys a new easement rather than acquiring the right of way subject to the existing easement. This procedure is recommended so that the easement can include language applicable to the new conditions.

- (c) **Quitclaim Deeds** – Quitclaim deeds are prepared by the region Real Estate Services Office. This process must be completed for Real Estate Services to obtain clear title to the right of way. The quitclaim deed may indicate a monetary value for which the utility is to be compensated for relinquishing its rights.
- (d) **Replacement Easements** – When WSDOT is acquiring an easement for transfer to a utility or granting an easement within WSDOT right of way, the easements are shown on WSDOT's official right of way plan. The replacement easement deed granted to the utility is described in accordance with the terms of an agreement.

Replacement easements remaining within WSDOT's right of way are subject to specific conditions, which will be negotiated with Real Estate Services.

200.03 Preliminary Engineering Agreements

A Preliminary Engineering (PE) Agreement is required when a utility requests reimbursement for design work, preparation of a cost estimate, and/or preparation of a relocation/construction plan. This applies only if WSDOT is financially responsible for all or a portion of the utility's facility relocation costs. Prior to entering into such an agreement, the utility must be proven to have a documented property right showing that it is eligible for reimbursement (see 200.02, Utility Property Rights). A PE Agreement is also required if WSDOT includes the relocation or construction of the utility's facility in a WSDOT project's contract, regardless of whether or not WSDOT is responsible for the utility's costs.

Federal Highway Administration (FHWA) policies and procedures, with respect to the preliminary engineering for phases of federal-aid highway projects, are explained in plain language in the *Program Guide: Utility Relocation and Accommodation on Federal-Aid Highway Projects* (www.fhwa.dot.gov/reports/utilguid/index.htm). The Program Guide includes the sections pertaining to utilities contained in the Code of Federal Regulations ([CFR Title 23](#)) that is interpreted in the Program Guide's plain language section. Observance of the federal regulations is required on projects involving any amount of federal funding. WSDOT has adopted this Program Guide and the attendant federal regulations for application to all fully WSDOT-funded highway projects as well.

(1) Preliminary Engineering Cost

The region Utilities Engineer and the utility may jointly determine the estimated cost of preliminary engineering. Preliminary engineering shall include a breakdown of labor hours, rates, materials, equipment, and any overhead costs with their percentages. Preliminary engineering can be performed by the utility, by a consultant hired by the utility, or by WSDOT.

If the utility has a consultant perform the preliminary engineering on its behalf, the utility and its consultant must agree in a written contract on the services to be provided and the fees for these services. Instead of a project-specific consultant agreement, the utility may use its existing continuing consultant contract for preliminary engineering services. However, the utility will need to demonstrate to WSDOT that such work is performed regularly by that consultant and that the costs are reasonable. The split in percentage of the work to be performed by the consultant and the utility is included in the heading of the PE Agreement.

The contract between the utility and its consultant, whether continuing or project-specific, may be subject to review by WSDOT. The utility is required to provide a copy of the consultant contract when requested to do so by the department. Contracts and associated preliminary engineering costs are subject to an audit by WSDOT or the FHWA, as appropriate. The utility and its consultant will be responsible for producing all the required records for any such audit.

(2) Preliminary Engineering Agreement Preparation

A cost estimate for the work to be performed is provided to you by either the utility, if it is doing its own design work, or by the Project Design Engineer, if WSDOT is doing design work for the utility. The estimate from the utility should have as much detailed cost information as possible. You should review the estimate to ensure the costs presented by the utility are reasonable. Overhead percentages are especially important because the overhead rates are often audited, and we want to make sure we are being charged appropriately. If you have questions about whether or not an overhead rate is reasonable, [HQ Utilities](#), Railroad, and Agreements can assist with that determination.

The first step after receiving a cost estimate for the agreement, whether from the utility or WSDOT's Project Design Engineer, is to obtain an agreement number. This is done by initiating an Agreement Review Transmittal (ART) form in the ART system, which will automatically generate your agreement number. Information you need to provide on the transmittal includes:

- State Route Number.
- Project title.
- Dollar amount of the agreement.
- Contractor (use the name of the utility the agreement is with).
- Contact person and phone number (list yourself).
- Agreement Manager and org. code
- Start and end dates
- Milepost limits
- Vendor number
- If Chapter 39.34 RCW applies
- Retention time for the agreement
- Reason for the agreement (for example, relocation of a utility waterline on an easement or inclusion of utility waterline construction in a WSDOT project)

Indicate (by checking the box) whether the agreement is reportable under the contracting policy, and select the agreement type under the pull-down menu. (Utility agreements associated with a construction project will be Public Works/Capital Projects.)

Following its issuance, include the UT number in the header of the agreement, on each page of the agreement, and on each of the exhibits prior to sending the agreement to Headquarters for review or to the utility for signature.

(a) **Preliminary Engineering Agreement Forms** – There are two types of Utility Preliminary Engineering Agreement forms: Work by State and Work by Utility. The variations of these forms depend on who is paying for the relocations or new installations.

The standard form Utility Preliminary Engineering Agreement variations are:

- Work by State – Utility Cost (DOT Form 224-301 EF)
- Work by Utility – State Cost (DOT Form 224-072 EF)

1. **Utility Preliminary Engineering Agreement – Work by Utility** – Standard form agreements are used when preliminary engineering is performed by the utility’s own forces or by a consultant retained by the utility, and some or all of the cost is WSDOT’s responsibility. The standard form agreement is used whenever possible; however, unique circumstances may require the use of a nonstandard agreement. If a standard form agreement is altered in any way after the statement “IT IS MUTUALLY AGREED AS FOLLOWS,” it is a nonstandard agreement and requires “approval as to form” by the Attorney General’s Office (AGO). AGO approval as to form is also required if the exhibit changes the terms of the standard form agreement.
2. **Utility Preliminary Engineering Agreement – Work by State** – Standard form agreements are used when a utility requests that WSDOT include utility relocations or construction of its facilities in the WSDOT project contract. In these cases, at least a minimal amount of preliminary engineering work will have to be performed by WSDOT. The financial responsibility may be the utility’s or WSDOT’s, depending on the utility’s property rights. Even if WSDOT is not doing the actual design of the utility’s facilities, WSDOT should recover the costs it incurs to incorporate the utility’s plans into WSDOT’s project contract unless the costs are WSDOT’s responsibility.

If the utility is responsible for any preliminary engineering cost for work to be performed by WSDOT, a utility agreement is required. If WSDOT is responsible for all costs, an agreement may or may not be required, depending on the individual circumstances.

(b) **Preliminary Engineering Agreement Elements** – The appropriate standard form agreement or nonstandard agreement will be used for the main body of the agreement. The legally binding sections of the agreement begin after the statement “IT IS MUTUALLY AGREED AS FOLLOWS.” The “WHEREAS” sections explain the conditions and any relevant information pertaining to why the agreement is being entered into. These sections can be modified without being considered a change to the standard form agreement or requiring a nonstandard agreement, only as long as the changes do not modify the terms of the agreement.

- (c) **Exhibit A: Special Provisions** – Exhibit A is used to further define those items of work that may be generally addressed in the body of the agreement or to clarify the specific work to be done. An Exhibit A should be limited to the actual work to be done and not used to modify or create agreement terms that address, for example, payment, right of entry, or indemnification. An Exhibit A is required if a standard form agreement is used. If a nonstandard agreement is used, work specifications may be included in the body of the agreement as long as it is appropriate to do so. Caution should be used to ensure the language in Exhibit A does not contradict the language in the standard form or nonstandard agreements; otherwise, the agreement could be found null and void and be indefensible in court. It is particularly important to avoid inconsistent terms between the Exhibit A and the standard form agreements, as they are usually not reviewed by the Attorney General’s Office.

Exhibit A includes a statement of the reason the agreement is being entered into (usually needed if a standard form agreement is used). Do not repeat an agreement term in Exhibit A if it is the same. Remember to number each paragraph section.

Sections that Exhibit A should or may contain are as follows:

1. **Scope of Work** – This section defines the work to be accomplished under the agreement, with a statement of the cost responsibilities of that work.
2. **Division of Work** – This section describes the proposed work separately under the headings “Work to Be Performed by the State” and “Work to Be Performed by the Utility.” Under each heading, the description of work should have sufficient detail to allow an accurate comparison between the work described in this section and the plan sheet exhibit. If no work is performed under one of the above headings, the heading is followed by the word “None.” A comparison between this Exhibit A, the cost estimate exhibit, and the plan sheet exhibit must show continuity among all three.
3. **Betterment** – This section states whether or not there is a “betterment” of the utility’s facility that is not due to a statute, industry standards, or other justification acceptable to WSDOT. A betterment is any upgrade in a utility facility that is in excess of the “replacement in kind” (see [Appendix A](#), Glossary) that the utility is entitled to as a result of its documented property right. When there is a betterment, the utility is responsible for all costs, including preliminary engineering costs, in excess of those it is entitled to for “replacement in kind.”
Note: It is not a betterment if the increased capacity is due solely to a statute, industry standard, or other acceptable requirement that the utility has to meet.
4. **Financial Responsibility** – This section states which party is responsible for the costs of the work and, if there is a shared cost, explains how the “proportional share” of cost responsibility for each party was determined. Percentages are often used for this purpose, and the percentages are derived from the estimated costs and applied to the actual costs. The percentages are most often determined by dividing the work between those portions of the facility to be relocated that are currently located with documented property rights (such as an easement, fee title, or court finding of prescriptive right) and those portions of the facility that have no documented property rights.

Note: Care needs to be taken with this method. If you divide based on just the lineal feet of the facility *on easements* versus the number of feet *not on easements*, the proportion may not reflect a real shared cost. The reason is that more expensive facilities may exist on one site and not on the other; for example, where a power facility has all the poles and aerial lines, except for one large vault not on an easement. If the shared cost does not recognize the higher cost of the vault in calculating the percentages, the shared cost will be skewed to the benefit of the utility facility on the easement.

- (d) **Exhibit B: Cost Estimate** – Exhibit B must include the position title of the person doing the work (specific employee names are not to be used, as personnel may change during the life of the agreement), the rate per hour, the number of estimated hours, and the total for each position. It may also include such items as consumables (such as paper or printing), equipment, and transportation. When possible, the costs supplied by the utility should be used; however, the region Utilities Agreements Engineer may choose to transfer the information over to a WSDOT format for clarification. If this is done, a copy of the utility’s estimate must accompany the agreement when you send the agreement to Headquarters. If the work is performed by WSDOT at the utility’s expense, sales tax is not applied to engineering costs. Advance payments for work to be performed by the utility are not legally authorized (see Article 8, Section 5, Washington State Constitution, Gift of State Funds).
- (e) **Exhibit C: Plan Sheets** – Exhibit C must consist of at least a vicinity map and the current location of any facility being relocated. The plans may show the proposed route for relocation, if known, with the understanding that this route may change during the course of the design of the relocation. If a new facility is being constructed where there was no existing facility, include a right of way plan showing the proposed area where the facility will be placed.
- (f) **Agreement Binding** – The agreements are to be bound in light blue jackets with 40-pound bond paper backing. The jackets for the originals of the agreements are to be labeled “State Original” and “Utility Original.” If a nonstandard agreement is with a city, the word CITY may be substituted for UTILITY in all appropriate sections of the agreement, including the label on the jacket of the agreement.
- (g) **Preparation of a Nonstandard Preliminary Engineering Agreement** – The usual reason nonstandard agreements are required is because a utility’s legal department has objected to the standard “Legal Relations” clause in the standard form agreement. When this is the case, the utility’s legal representative will need to provide alternate language to be included in the agreement. If the language supplied by the utility is unacceptable to WSDOT, some negotiations involving both legal representatives may be necessary. Since it is a change to the agreement’s legal language, this kind of change cannot be addressed in Exhibit A, Special Provisions, without creating a conflict in the agreement’s language. Such a change would nullify the terms of the agreement, rendering it invalid and indefensible; therefore, a nonstandard agreement must be written.
 - 1. There is no format prescribed for nonstandard PE Agreements. The method typically used is to copy the standard form agreement language for the type of agreement being written into a separate Microsoft Word document and then make modifications to the agreement form as necessary. The nonstandard agreement should contain all of the information and exhibits

from the standard form agreement that are relevant to the nonstandard agreement.

Note: It is required that any nonstandard agreement be reviewed by Headquarters and, if necessary, be approved as to form by the Attorney General's Office before the agreement is sent to the utility for signature.

2. If the Exhibit A is not used in a nonstandard agreement because everything was covered in the main body of the agreement, Exhibit B, Cost Estimate, may become Exhibit A, and the plan sheets that are normally Exhibit C become Exhibit B.

Note: This is applicable only to an original agreement and may not be applied to an amended agreement where an Exhibit A, titled Special Provisions, was included in the original agreement.

3. If it is a nonstandard Agreement Amendment, the references must remain consistent with the original exhibit designations of Exhibits A, B, and C, with the number of the amendment added; for example, an Amendment 1 would have Exhibit A-1, Exhibit B-1, or Exhibit C-1 if the exhibits are modified. If the original nonstandard agreement referenced Exhibit A as the Cost Estimate, Exhibit A-1 must also be Cost Estimate. However, if final actual costs are known and are shown in the exhibit, the title should change to Exhibit (A or B) of Costs instead of Cost Estimate, since it is no longer an estimate. This applies whether the cost exhibit is Exhibit A or B.

(3) Preliminary Engineering Agreement Amendments

Typically, PE Agreements are amended whenever WSDOT or the utility will exceed the allowable cost estimates of the original and any previous amendments to the PE Agreement. Such amendments to the agreement should be finalized prior to the utility or WSDOT exceeding the cost estimate of the original agreement or prior amendments. It is not always possible to amend the agreement in time to avoid a project delay. If this is the case, the region Project Design Engineer, or the appointed authority for that project, needs to write a letter to the utility giving it permission to proceed with its design. The letter must inform the utility that WSDOT will not be able to reimburse the utility for its work until the Agreement Amendment is executed.

Amendments to standard and nonstandard Preliminary Agreements are written in the form of a nonstandard agreement and are sent to Headquarters for review. If the language, scope of work, and/or intent of the standard form agreement does not change, Headquarters can recommend region execution. If the amendment to the standard form does change the scope of work, intent, and/or language of the agreement, the amendment may require approval as to form by the Attorney General's Office (AGO). An Agreement Amendment's references to the exhibits must remain faithful to the original exhibit, with the number of the amendment added after the alphabetic exhibit designation; for example, if it is Amendment 1, it would have Exhibit A-1, Exhibit B-1, or Exhibit C 1. The review procedures for amendments to all nonstandard agreements will follow the same process as the original agreement, which requires review by Headquarters and the AGO.

Note: Previously, Agreement Amendments were called Agreement Supplements. The AGO determined that we should be amending agreements and not supplementing them. Therefore, if you see older agreements that either refer to or are named supplements, they were completed prior to this change in terminology.

(4) Agreement Processing for Region Approval

(a) Agreement Processing for Work by Utility's Own Forces or Work by State

1. The region prepares the standard form PE Agreement. The region then sends two originals (one labeled "State" and one labeled "Utility" or "City") of the agreement to the utility requesting signature by its designated authority. The designated authority is the person who has the right to sign the agreement on behalf of the utility. It is best to confirm who has such authority before sending the agreement to the utility for signature. The request needs to inform the utility to return BOTH (if you don't emphasize "both," you may get back only one) of the originals for final execution by WSDOT and that, upon final execution, the duplicate original marked "Utility Original" (or "City Original") will be returned to the utility.
2. Following signature by the utility and return to the region of the duplicate originals, the Regional Administrator or a delegated representative signs the duplicate originals of the agreement. This authority varies from region to region.
3. Upon approval of a Work Order Authorization, the region notifies the utility that preliminary engineering work covered under the agreement may proceed as of the effective date of the agreement.
4. The region transmits the original of the fully executed PE Engineering Agreement to the HQ Division of Accounting & Financial Services (AFS), with a completed copy of the current Agreement Review Transmittal form.

Note: The Agreement Review Transmittal form is required to set up the agreement in the accounting system and must accompany every agreement sent to the AFS. The effective date on the front or last page of the agreement and the Start Date in the Agreement Review Transmittal form must match. The Start Date is the date from which the utility can be reimbursed. If advanced authorization was given to the utility to perform the work prior to the execution date, the date it was authorized to start work—not the execution date—must show on the last page of the agreement.

(5) Agreement Processing

(a) Standard Form Agreement: Headquarters Review

1. The only time it is required that a standard form agreement be reviewed by Headquarters is when the facility is to be located longitudinally within Interstate right of way or there is to be open cutting of the roadway or shoulder by the utility. In these cases, the region prepares the standard form PE Agreement and electronically transmits the complete agreement to Headquarters in its preferred format. The region retains standard form agreement originals pending HQ Utilities review and approval.
2. HQ Utilities prefers that all agreements to be reviewed be electronically submitted using level-playing-field software such as, but not limited to, MS Word, MS Excel, and, for scanned Exhibit C plans, Adobe PDF files. An Agreement Review Transmittal form is added to the database by the agreement writer, and the agreement documents are attached to an e-mail and sent to the Headquarters reviewer. The e-mail must include the request for review and the reason for the agreement.

(b) Nonstandard Agreements

1. An Agreement Review Transmittal form is added to the database by the agreement writer. The region prepares the nonstandard PE Agreement and electronically (by email attachment) submits the documents to HQ Utilities for review using level-playing-field software such as, but not limited to, MS Word, MS Excel, and, for scanned Exhibit C plans, Adobe PDF files.
 2. HQ Utilities reviews the agreement and secures approval as to form from the Attorney General's Office for nonstandard agreements. The review includes, but is not limited to:
 - Inclusion of necessary documents: cost sheet, plan sheet, scope of work, Memorandums of Understanding (MOUs), Letters of Understanding (LOUs), and other documents mentioned in the body of the agreement.
 - Engineering issues: location of facility (vertical and horizontal), crossing locations, access breaks, material quantities, easements, and quantities.
 - Compliance with the *Utilities Accommodation Policy*.
 - Financial accuracy: materials, quantities, unit costs, hourly rates, benefits, travel costs, overhead rates, and calculations. Be sure the appropriate percentages are applied for engineering, contingencies, mobilization, and sales tax.
- Note:* LOUs do not create legally binding commitments.
3. The HQ Design Office obtains FHWA review/approval for all nonstandard PE Agreements for projects on the Interstate System.

(6) Headquarters Approval

HQ Utilities reviews the agreement for completeness, accuracy, acceptability of accounting, and compliance with applicable laws and policies. Upon completion of the Headquarters review, the agreement is returned to the region for consideration of Headquarters' suggestions/comments and for the opportunity to make changes. After region consideration, the agreement is returned to Headquarters. HQ Utilities then submits the nonstandard agreement to Attorney General's Office (AGO) for "approval as to form" (see [Appendix A](#), Glossary). The language of the standard form agreement is preapproved as to form and no AGO review is required. However, you must make sure that the language in the exhibits does not contradict the language in either the standard form or nonstandard agreements, as this could render the agreement null and void and make it indefensible in court. If you have questions about whether or not language you are using in an exhibit is going to conflict, it is best to consult HQ Utilities for assistance and a determination.

The HQ Utilities Unit will either notify the region that the originals of the standard form agreement may be sent to the utility for signature or will return the originals of the nonstandard agreement with the AGO approval signature to the region for the utility's signature.

Do not have the utility sign the agreement until HQ Utilities review and approval are completed.

(7) Post-Headquarters Processing

- (a) **Region Processing Following Headquarters Review** – The region sends the duplicate originals of the agreement to the utility requesting signature by its designated authority. The request also needs to inform the utility that it must return BOTH of the originals for final execution by WSDOT and that, upon final execution, the duplicate original marked “Utility Original” (or “City Original”) will be returned to the utility.

Following signature by the utility and return to the region, the Regional Administrator or delegated representative signs the duplicate originals of the agreement. This constitutes “final execution” of the agreement, and it is now a legally binding document. The region then sends the Utility/City original to the Utility/City and the WSDOT original to HQ Utilities, which will attach the Agreement Review Transmittal form and deliver it to the HQ Division of Accounting & Financial Services. This is for reviewed agreements only.

(8) Region Disbursement

Copies of the agreements are sent to the appropriate region recipients according to the requirements or needs as determined by each region. For Preliminary Engineering (PE) Agreements, the minimum dispersal would be to the Project Design Engineer and region Program Management. Other recipients could include the plan review staff, Project Construction Engineer, region Real Estate Services Office, and region Financial Services Office. The region Utilities Office shall maintain copies of all PE Agreements in its files.

- (a) **Programming of Funds** – The region must have an approved Work Order Authorization and, when federal funds are involved, an approved Request for Federal-Aid Project Approval and Authorization. These forms are usually filled out and submitted by region Program Management when setting up the agreement in the accounting system.
- (b) **Authorization to Proceed** – The date on the front or last page of the fully executed PE Agreement is the effective date of that agreement and must reflect the start of the work covered by the agreement. The effective date of the agreement and the start of work date on the Agreement Review Transmittal form must match. The Start Date is the date from which the utility can be reimbursed. If advanced authorization was given to the utility to perform the work prior to the execution date, the date it was authorized to start work—not the execution date—must show on the first page of the agreement.

Note: It is acceptable to send a scanned or faxed copy to the utility so the work can proceed without waiting for the mailed copy.

200.04 Construction Agreements

A Construction Agreement is required to be completed when:

- A WSDOT project impacts existing utility facilities located pursuant to a documented property right (see [200.02](#), Utility Property Rights); or
- A utility requests that its facility relocation and/or new installation work be included in the construction contract for a WSDOT project.

(1) Construction Agreement Forms

There are two types of Construction Agreement forms: Work by State and Work by Utility. The variations of these forms depend on who is paying for the relocations or new installation work (see [200.02](#), Utility Property Rights). The standard form Utility Construction Agreement variations are:

- Work by State – Utility Cost (DOT Form 224-062 EF)
- Work by State – Shared Cost (DOT Form 224-071 EF)
- Work by Utility – State Cost (DOT Form 224-053 EF)
- Work by State – State Cost (DOT Form 224-077 EF)
- City Construction and Maintenance Permit (DOT Form 224-035 EF)

These standard forms may not be altered in any way after the statement “IT IS MUTUALLY AGREED AS FOLLOWS”; otherwise, a nonstandard agreement must be used. Which standard agreement form to use will be determined by which party is responsible for what costs, whether a utility occupies state right of way by franchise/permit, or whether the utility is located on a documented property right (see [200.02](#), Utility Property Rights).

(2) Letter of Understanding (LOU)

The LOU is used by WSDOT to establish the scope, schedule, and responsibility of costs for adjusting utility facilities (such as manholes, valve boxes, or vaults) to finished grade as required by a department paving project. The utility has the option of adjusting its own facilities or letting WSDOT adjust the utility facilities under the WSDOT project. The department generally prefers to adjust these utility facilities as part of the paving project; as a result, the LOU is written to encourage the utility to allow WSDOT the right to adjust its facilities.

The use and application of the LOU for utility adjustments is at the region’s discretion. (LOUs do not create legally binding commitments.) The document(s) are numbered and tracked according to each region’s requirements.

(3) Nonstandard Agreement

When unusual or unique conditions exist, or when a standard form agreement is not applicable, a nonstandard agreement may be used. However, it should be used with the understanding that this type of agreement will need to be reviewed by [HQ Utilities](#) and approved as to form by the Attorney General’s Office, thereby increasing the time required to complete the agreement.

(4) Agreement Exhibits

The Construction Agreement contains Exhibit A, Exhibit B, and Exhibit C, which are described in detail as follows:

(a) Exhibit A: Special Provisions

Exhibit A includes a description of work and a division of work. Please make sure the provisions of Exhibit A do not contradict the provisions of the standard form agreement or nonstandard agreement. Such contradictions cause ambiguity in the agreement, which will make it not enforceable. There is no need to repeat an agreement term in Exhibit A if it is the same. Further, number each paragraph

section. The following are brief summaries of some of the items that can be included in this exhibit:

1. **Scope of Work** – This section defines the work to be accomplished under the agreement, with a statement of the cost responsibilities of the work to be done.
2. **Division of Work** – This section describes the proposed work separately under the headings “Work to Be Performed by the State” and “Work to Be Performed by the Utility.” Under each heading, the description of work should have sufficient detail to allow an accurate comparison between the work described in this section and the Exhibit C Plans. If no work is performed under one of the above headings, the heading is followed by the word “None.” A comparison between Exhibit A, Exhibit B (Cost Estimate), and Exhibit C (Plans) must show continuity, not inconsistencies, among all three.
3. **Work by Contract** – When the utility has a valid and continuing contract with a contractor(s) to perform utility facility relocation or new work, and if WSDOT has reviewed and approved the contract, the following statement is included in this exhibit:

The work shall be performed by (name and address of contractor) under a continuing contract authorized by the state.

If the utility enters into a specific contract or agreement with a contractor to perform all or part of the work required under the agreement, a reference is not required in Exhibit A. However, written approval of the bid and the contractor by WSDOT may be required. Submit the contractor’s contract or agreement along with the bid documents to [HQ Utilities](#) for approval if required.

4. **Salvage** – If salvage is anticipated, and the utility is expected to see a cost benefit from the salvage materials, that cost benefit is to be credited to the state. A brief description of the salvage is shown in Exhibit A and an estimate of salvage credit is included in Exhibit B, Cost Estimate. In a nonstandard agreement, the salvage issue may be addressed in the body of the agreement.
5. **Disconnect and Removal** – If utility facilities will be removed by WSDOT’s contractor and if WSDOT is liable for the costs, the following statement is included as part of Exhibit A:

The utility agrees to disconnect the facilities shown on Exhibit C that will be removed by the state’s contractor at state expense within (___) days of the request by the state.

When a nonstandard agreement is used, the “disconnect and removal” statement may be included in the body of the agreement.

6. **Betterments** – A “betterment” is any upgrade in a utility facility in excess of the “replacement in kind” (see [Appendix A](#), Glossary) that the utility is entitled to as a result of its documented property right. When there is a betterment, the utility is responsible for all costs in excess of those it is entitled to for “replacement in kind.” It is not a betterment if the increased capacity is due solely to a statute, industry standard, or other acceptable

requirement that the utility has to meet. This section states whether or not there is a betterment of the utility's facility that is not due to a statute, industry standard, or other justification acceptable to WSDOT.

If the work involved does not contain a betterment, include a statement in Exhibit A stating that no betterment is involved in the work. In nonstandard agreements, this statement may be included in the body of the agreement.

Betterment credits are the financial obligation of the utility. No betterment credit is required when an existing facility's size or capacity is increased if the increase is required by governmental policy or regulations, local ordinance, or current design practices regularly followed by the utility in its own work or when there is a direct benefit to the WSDOT project. The region must retain copies of these regulations, ordinances, policies, and so on, as supporting project documentation. Documentation should show whether the betterment is for WSDOT's benefit or for the benefit of the utility.

7. **Accrued Depreciation Credit** – This credit is required when there is a replacement of a major facility such as a building, pumping station, filtration plant, power plant, substation, or any other similar operational unit. The credit, if applicable, is included by an explanation in Exhibit A. A credit is not required for a segment of a utility's mains, pipelines, service, distribution, transmission lines, or similar facility, regardless of length. The accrued depreciation credit is based on a ratio between the period of actual facility service and the total useful life expectancy applied to the original cost. The value of the accrued depreciation credit and the calculations used to compute this credit shall be included in Exhibit B, Cost Estimate.
 8. **Easements** – When WSDOT grants a replacement easement to the utility for its relocated facilities, Exhibit A shall include a legal description of the easement, as well as the terms and conditions of the easement.
 9. **Permit or Franchise** – If a permit, franchise, or amendment to a franchise or permit will be issued to the utility for relocation or new work done under the agreement, include a statement that the utility shall apply for, and WSDOT will grant, the necessary permits, franchises, and franchise amendments ([Chapter 47.44 RCW](#)).
- (b) **Exhibit B: Cost Estimate** – Exhibit B details the cost of utility relocation work or new installation work to be performed under the agreement. If the costs are known, this exhibit shall be titled "Cost Estimate." For Work by Utility Agreements, the cost estimate must show removal costs separate from installation costs. Removal and installation costs should be further broken down by labor, materials, and equipment. The cost estimate supplied by the utility for a Work by Utility Agreement is used in the format provided by the utility. As a guide, WSDOT may provide an example cost estimate for the utility to use in constructing its estimate. However, the utility is not required to follow the department's format. If WSDOT reformats the cost estimate prepared by the utility, include the original utility cost estimate as part of Exhibit B. Standard Bid Items, with their corresponding Standard Bid Item Numbers, are contained in the cost estimate when the agreement is for Work by State. Specific portions of some of the items in the cost estimate are as follows:

1. **Labor, Materials, and Equipment** – Provide labor costs for the number of hours estimated for each job title such as foreman, lineman, operator, and so on. The hourly rate for each title may include labor overhead, or the percentages for these may be added to the total direct labor costs. In either case, provide a breakdown list of these percentages in the estimate. List the material and supply costs in sufficient detail so it can be determined by review whether or not estimated costs are reasonable. The material items shall be identified by a common name (such as 50-foot wooden pole, 8-foot cross-arm, or 6-inch gate valve) and not just a letter or number code designation.

The utility may use code designations in the estimate if the utility provides WSDOT with a list of the corresponding common names for the material codes used. Overhead or handling costs for materials may be included in the estimate if the utility routinely charges these costs as a part of doing business and this can be supported by the utility's records. Under equipment costs, include the name or description of each piece of equipment, the unit rate of charge (such as miles or hours), and the estimated number of units.

2. **Betterment Credit** – Additional costs resulting from the upgrade in size, material, or capacity of utility facilities, other than what is currently required by governmental policy or regulations, local ordinance, or design practices followed by the utility, shall be the responsibility of the utility. These additional costs shall be reflected in the cost estimate as a credit to WSDOT.
3. **Salvage Credit** – When utility items removed from service are sold or reused by the utility, the value of these items shall be shown as a salvage credit in Exhibit B, which should list the description, quantity, and value of the items. The total salvage value shall be subtracted from the costs shown in Exhibit B, resulting in a decrease in the bottom line of the cost estimate.
4. **Accrued Depreciation Credit** – A credit to WSDOT is required for the accrued depreciation of a utility facility being replaced, such as a building, pumping station, filtration plant, power plant, substation, or any other similar operational unit. Find a detailed discussion on accrued depreciation in FHWA's *Program Guide: Utility Relocation and Accommodation on Federal-Aid Highway Projects*, Publication No. FHWA-IF-03-014: www.fhwa.dot.gov/reports/utilguid/index.htm

A separate estimate detailing the computation of the credit is required as part of Exhibit B. If original cost figures for the facility being replaced are not available, contact [HQ Utilities](#) for the procedures used to establish the amount of accrued depreciation credit.

5. **Mobilization** – In Work by State Agreements, the utility is financially responsible for a portion of the total WSDOT mobilization costs if the utility does not have a documented property right. Mobilization is shown in Exhibit B as a cost to the utility based upon a proration of the cost of the work attributed to the utility to the total cost of the project. This proration is based on the actual bid prices received for the awarded WSDOT contract.

The cost estimate for Work by Utility Agreements may or may not include mobilization costs. When the utility uses its own labor and equipment, the mobilization costs may be included in the hourly rate submitted for labor and

equipment. Include a note in Exhibit B, after the Agreement Cost Summary, explaining the mobilization costs used in the agreement.

6. **Sales Tax Applicability** – Use the following guide to determine whether state sales tax is appropriate as an added item in the cost estimate. Use the Control Section Tax Tables (contact region Program Management for the current tables or rates) to determine the applicable sales tax rate. This is especially useful in determining whether sales tax is appropriate for work to be done inside the corporate limits of a city.

Conditions	Highway Owned by the State	Highway Not Owned by the State
The readjustment of utilities by utility forces at state expense (no sale made).	No	No
The readjustment of utilities by a contractor procured by the utility at state expense.	Yes	No
The readjustment of utilities by WSDOT's contractor at WSDOT's expense.	Yes	No
The readjustment of utilities by WSDOT's contractor at the utility's expense.	Yes	Yes

Sales Tax Applicability

Figure 200-1

To further clarify when sales tax should be added to the estimate, see Sections 107.2(1) and 1-07.2(2) of the *Standard Specifications for Road, Bridge, and Municipal Construction*.

7. **Engineering Costs** – Engineering costs for Work by State Agreements are computed as a proration of the total cost of the agreement to the total cost of the project. The engineering percentage rate to be used for estimating and progress payment purposes shall be taken from the *Plans Preparation Manual*. Include a note in Exhibit B, after the Agreement Cost Summary, explaining the engineering costs used in the agreement.
8. **Administrative Overhead**
- Indirect Cost Rate** – When WSDOT performs work for a utility, WSDOT shall apply its current Indirect Cost Rate to the total project costs. The current Indirect Cost Rate is calculated by the HQ Division of Accounting & Financial Services (AFS). New rates must be approved by FHWA prior to WSDOT being able to charge them. The rates are then effective during the current federal fiscal year, which is July 1 through June 30 of the following year.
 - Reciprocating Overhead Agreement** – If the utility is owned and operated by a municipality, and a Reciprocating Overhead Agreement¹ exists between the municipality and WSDOT, then the Indirect Cost Rate

¹ In a Memorandum from the Chief Engineer on April 29, 2010, the department was instructed that as of July 1, 2011, these agreements are no longer in effect, and as of June 2013, the use of Overhead Agreements will be discontinued.

is not applied. Include a note in Exhibit B, at the end of the Agreement Cost Summary, explaining that the Indirect Cost Rate was not applied to the agreement costs due to the existence of a Reciprocating Overhead Agreement. Show the agreement number and the effective date.

Regions request approval for new Reciprocating Overhead Agreements from the HQ AFS. New agreements will not be approved by the AFS unless WSDOT will actually receive a benefit by doing so. New agreements will also not be approved solely for the benefit of the city, town, or county. The region Accounting Office maintains a current list of Reciprocating Overhead Agreements.

9. **Cost Sharing** – When WSDOT and the utility share the cost of the relocation, the method of establishing each party’s share must be shown in Exhibit B. Show the shared costs in percentages using one of the following two methods:

- The percentage was established by comparing cost estimates of work for which each party is responsible.
- The percentage was established by comparing the length of the facility for which each party is responsible. This is acceptable only if the construction features are reasonably similar for each party’s portion of the facility.

The first method is preferred because it eliminates the impact that variables can have on the cost of the work. Exhibit B should note that this percentage split is fixed and shall be applied to the actual cost of the work.

10. **Agreement Summary Sheet** – A page titled “Agreement Summary Sheet” may be included as the last page of Exhibit B of a Construction Agreement or an Agreement Amendment. The Agreement Summary Sheet will contain all costs attributed to a single agreement number, such as the original Construction Agreement and all subsequent Agreement Amendments.

Following is an example of information on an Agreement Summary Sheet:

UT 97301 Construction Agreement	\$25,000
UT 97301 Amendment No. 1 Construction Agreement	\$15,000
<u>UT 97301 Amendment No. 2 Construction Agreement</u>	<u>\$10,000</u>
Total to Date	\$50,000

- (c) **Exhibit C: Plans** – Maps and plan sheets included as part of a Construction Agreement are labeled as Exhibit C. The plans are a necessary and valuable part of the agreement and should be prepared with the same care and attention to detail as WSDOT’s highway project plans. Plan exhibits must show the highway centerline and stationing, existing right of way line, new right of way line, and limited access line. If the utility work is involved in a current proposed highway project, the highway project plans may be used in place of the current right of way plan or combined right of way/limited access plans.
- Show existing facilities that are (1) to remain in place and in use, or (2) to remain in place but be deactivated (or abandoned, under limited circumstances), but still owned by the utility.

- Show existing facilities that are to be removed or relocated as a heavy solid green line.
 - Show relocated facilities or new facilities as a heavy solid red line.
- (d) **Construction Agreement Processing** – If a Construction Agreement is warranted, the following procedures apply to the preparation and execution of the agreement:
1. Obtain an agreement number by initiating an Agreement Review Transmittal (ART) form in the ART system, which automatically generates your agreement number.
 2. Prepare the agreement using one of the standard form agreements, or prepare a nonstandard agreement if necessary, and attach the appropriate exhibits. The agreement originals require jackets made of 40-pound light blue bond paper. The jackets of the original agreements are labeled as “State Original” and “Utility or City Original.”
 3. All Construction Agreements are executed by the Regional Administrator or a delegated representative.
 4. When utility work is included in a proposed highway project, the Construction Agreement will be compared to the preadvertisement Plans, Specifications, and Estimates (PS&E) by the region Utilities Office. Inconsistencies may require an agreement amendment.
 5. All Construction Agreements involving longitudinal work within the right of way of the Interstate System require review by HQ Utilities and FHWA for compliance with state and federal laws and policies and accounting provisions.
 6. A Headquarters review may include input from the following offices:
 - The Agreements section of HQ Utilities, Railroad, and Agreements will do an acceptability review. Any alterations to the agreement following the Agreements section acceptability review require a subsequent review by HQ Utilities.
 - Headquarters offices that have specific expertise in areas of work included in the agreement will review the agreement and PS&E when the work is associated with a proposed highway project.
 - HQ Real Estate Services will review the agreement when there are changes in property ownership, including easement and/or quitclaim deeds or right of way revisions.
 - The Attorney General’s Office will be asked for an “approval as to form” for all nonstandard agreements.
- (e) **Agreement Approval and Execution Procedure**
1. **Standard Form Agreement: No Interstate Issues** – Send two originals to the utility for signature: one for a “State Original” and another for a “Utility or City Original.” After both signed documents are received from the utility, obtain the signature of the Regional Administrator or delegated representative on both originals. Retain one copy for the region Utilities Office. Send the

executed State Original and a copy of the Agreement Review Transmittal form to the HQ Division of Accounting & Financial Services. Return the Utility or City Original to the utility. Send a copy of the agreement to region Program Management, the region Financial Services Office, and the Project Engineer's Office.

2. **Standard Form Agreement: Longitudinal Interstate Issues** – E-mail a copy of the agreement to HQ Utilities for Headquarters and FHWA review and concurrence. After resolving any concerns by HQ Utilities and FHWA, follow the procedure for agreement approval and execution as outlined under Standard Form Agreement: No Interstate Issues (above).
3. **Nonstandard Agreements** – E-mail a copy of the agreement to HQ Utilities for Headquarters review and concurrence. FHWA may need to review for an Interstate Agreement. After successful review by all interested parties, and an approval as to form by the Attorney General's Office, HQ Utilities will send a signed original back to the region. For approval and execution of the agreement, follow the procedure as outlined under Standard Form Agreement: No Interstate Issues (above).
4. **Letter of Understanding (LOU)** – Send the LOU, signed by the region Utilities Engineer, to the utility by Certified Mail. The signed Certified Mail receipt will document that the utility received the LOU and was aware of all the terms and conditions stated in the LOU. When the utility decides to adjust its own facilities, it will either not return the LOU by the required date or it will return the LOU, indicating its rejection of the terms and conditions. For these situations, send a copy of the LOU to:
 - The Project Design Engineer, with a letter stating that adjustment of the utility's facilities should not be included in the WSDOT contract and that any utility facilities may be paved over unless they are provided for adjustment.
 - The Project Construction Engineer, with a letter stating that the utility will adjust its own facilities and that the utility should be invited to the Preconstruction Conference.

When the LOU is returned from the utility with a signature of acceptance, the document(s) are numbered and tracked according to each region's requirements. (LOUs do not create legally binding commitments.)

5. **Authorization to Proceed** – The date shown on the last page of the agreement is established as the date of authorization to proceed. This date is set after all Headquarters requirements are met and after the agreement is executed and an approved Work Order Authorization (WOA) is completed. Without an approved WOA, costs incurred under this agreement may be ineligible for coverage.

(5) Utility Agreement Amendment

In the event that unforeseen conditions or circumstances result in the need for additional work beyond the scope of the agreement and associated increases in costs beyond the maximum payable amounts under the original agreement, an Agreement Amendment will be required to be executed between the parties prior to such additional costs being incurred. If it becomes necessary to commence such additional utility work immediately in order to avoid project schedule delays and/or avoid further project costs, the Agreement Manager may authorize such additional work in advance of formal execution of an Agreement Amendment, provided that the authorization is in writing. The Utility may not be reimbursed for any costs beyond the maximum payable amount under the original agreement unless an Agreement Amendment has been executed.

An amendment is needed when unforeseen conditions require an increase that exceeds a set percentage of overrun agreed to in the original agreement, above the cost estimate in Exhibit B, or when the scope of work is significantly changed. The original agreement is modified by an Agreement Amendment covering said increase.

Amendments to standard and nonstandard Construction Agreements are written in the form of a nonstandard agreement and are sent to Headquarters for review. If the language, scope of work, and/or intent of the standard form agreement does not change, Headquarters can recommend region execution. If the amendment to the standard form does change the scope of work, intent, and/or language of the agreement, the amendment may require approval as to form by the Attorney General's Office (AGO).

An Agreement Amendment's references to the exhibits must remain faithful to the original exhibit, with the number of the amendment added after the alphabetic exhibit designation; for example, if it is Amendment 1, it would have Exhibit A-1, Exhibit B-1, or Exhibit C-1. Review procedures for amendments to all nonstandard agreements will follow the same process as the original agreement, which requires review by Headquarters and the AGO.

The region must have an approved Work Order Authorization and, when federal funds are involved, an approved Request for Federal-Aid Project Authorization and Agreement prior to commencement of the amendment work.

- 300.01 General
- 300.02 Responsibilities
- 300.03 Railroad Requirements
- 300.04 Railroad Crossings

300.01 General

Railroad negotiations require extended time and effort to complete and therefore need the earliest possible attention of Washington State Department of Transportation (WSDOT) region and Headquarters (HQ) personnel. In some cases it may take up to one year to complete an agreement. If a project involves a railroad, make early contact with both the railroad and the HQ Railroad Liaison.

300.02 Responsibilities

(1) Headquarters Railroad Liaison

The HQ Railroad Liaison:

- Coordinates between project offices and railroad companies when projects impact railroad facilities.
- Transmits proposed work data to railroad companies.
- Develops and negotiates railroad construction and maintenance agreements.
- Keeps Region Utilities Engineers informed about railroad agreements under development.
- Authorizes the railroad to begin work.
- Provides guidance on railroad crossing design and policy.
- Assists in railroad right of way matters (primary responsibility for this function belongs to the HQ Real Estate Services Office).
- Administers the WSDOT railroad grade crossing inspection program.
- Assists the regions in securing grants for grade crossing safety projects and managing funded projects at the discretion of the regions.

(2) Region Responsibilities

The Regional Administrator typically designates the Region Utilities Engineer as the person responsible for the following railroad matters:

- Advise the HQ Railroad Liaison of all projects with railroad involvement.
- Maintain records/files of region railroad involvement.
- Maintain working contact with the HQ Railroad Liaison.
- Furnish or facilitate plan/project submittals to the railroad to secure necessary agreements, approvals, and information.

- HQ Railroad Liaison keeps the regions informed of any follow-up actions required, including meeting with railroad officials if requested or required.
- Review draft railroad agreements provided by the HQ Railroad Liaison.
- Perform the construction administration of the agreement in accordance with this chapter.
- Report to Headquarters when the project is completed.

When the region receives utility accommodation requests in the vicinity of railroad ownership, closely review WSDOT's rights, and refer utilities to the railroad company when necessary (see [Chapter 5](#), Government Agencies: State, Federal, Tribal, and Other Entities).

(3) Railroad Coordination During Highway Construction

The region is responsible for coordinating all work conducted under a railroad agreement, from the date the railroad is authorized to proceed, through completion of the work, closing of the agreement, and completion of the final audit. The HQ Railroad Liaison is available as needed during the process.

(4) Roadmasters

Region Utilities Engineers should establish good working relationships with roadmasters for railroads operating in the region. When a project is under development, it is advisable to contact the roadmaster and go over the work anticipated on, under, or above railroad properties, including method of access and protective services the railroad may require. The region should keep the HQ Railroad Liaison informed of any such discussions.

(5) Railroad Billings

Billings from the railroad are received by the Region Utilities Engineer or the office assigned to administer the agreement. The region is responsible for ensuring the costs billed by the railroad are accurate and in conformance with the agreement. Costs should be clearly identified on an in-depth billing. If a billing is inaccurate or incomplete, the region is responsible for sending a response to the railroad detailing the deficiencies.

300.03 Railroad Requirements

(1) Railroad Right of Way

Work by the state on railroad property requires that the state have a property right, which the railroad generally grants by easement or temporary occupancy permit. The HQ Real Estate Services Office is responsible for obtaining easements from the BNSF Railway Company and the Union Pacific Railroad Company. Region Real Estate Services offices are responsible for easements when other railroads are involved. Temporary occupancy permits (TOPs) vary according to the scope of work and are handled according to areas of responsibility. For example, TOPs needed for utility crossings should be submitted by the Region Utilities Office; TOPs related to a property acquisition should be handled by Real Estate Services

(Headquarters or region depending on the railroad, as described above); and TOPs needed for construction access are coordinated through the Region Utilities Engineer. The HQ Railroad Liaison assists as needed.

WSDOT employees who will be working on railroad right of way will need to comply with the safety requirements of the railroad, which may include a short training class, steel-toed boots, hard hats, and high-visibility safety clothing. Specifics differ from one railroad to another.

(2) Railroad Agreements

Formal agreements with the railroad are typically required for construction projects taking place within railroad property or where the railroad will be reimbursed for work done at the state's request. Agreements may not be needed where the work will take place entirely inside bridge railings and where WSDOT's contractor will not need to access railroad property. When a formal agreement is necessary, the HQ Railroad Liaison will negotiate an agreement with the railroad and prepare it in accordance with the *Agreements Manual*.

(3) WUTC Petitions

If the project involves modifying, opening, or closing a railroad grade crossing, a Washington Utilities and Transportation Commission (WUTC) petition will likely be required per [WAC 480-62-150](#). The WUTC regulates safety at all public grade crossings in Washington outside first class cities.

- The HQ Railroad Liaison will coordinate with the WUTC and file the necessary petitions. The region must provide the roadway and traffic data required by the petition.
- Once the petition is complete, the HQ Railroad Liaison signs it and forwards appropriate copies to the WUTC and the railroad company.
- When the WUTC completes its review and issues an order, it will be returned to the HQ Railroad Liaison who will retain a copy for the records and forward a copy to the Region Utilities Engineer.

(4) Construction Drawings

Plans for projects that involve building or altering roadway facilities on or affecting railroad property require the railroad company's approval. The primary consideration is meeting the requirements for railroad clearances and design. To expedite this review process, the region should develop a railroad exhibit that specifies impacts to railroad facilities, including horizontal and vertical clearances between the tracks and any new structures; roadway and shoulder widths; and placement of warning devices for railroad grade crossing projects. Other items that require prior railroad approval are falsework, shoring, demolition, and drainage plans.

(5) Railroad Insurance and Flagging

Railroad insurance and flagging will likely be required in connection with construction of highway projects where any portion of the work is within railroad right of way. The General Special Provision, *Relations With Railroad*, provides this information. Questions regarding insurance or flagging should be referred to the HQ Railroad Liaison.

Flagging costs from the railroad that are not associated with a formal agreement should be charged to a separate group in Group Category 99 (Vendor-Supplied Services and Materials). The group should be set up not to accept labor (Labor N), as the group will only be used when making payments to the railroad for flagging.

(6) Pipe, Pole, or Wire Occupancy Permits

These permits are completed by the Region Utilities Engineer. In some cases, it is possible to provide convincing information to the railroad that there are mutual benefits for the requested installation—in which case there may be no charge for the permit. The region should keep track of the various permits issued by assigning each one a region service agreement number.

(7) Maintenance Notifications

Any maintenance work within railroad rights of way requires advance notification and approval from the railroad.

(a) Maintenance Near At-Grade Crossings

[WAC 480-62-305\(4\)](#) requires road authorities to provide at least ten days' notice to the appropriate railroad company whenever it "plans to perform maintenance that will affect a (railroad grade) crossing." In practice, the region should notify the railroad roadmaster whenever any work is planned to occur within 25 feet of the tracks at a grade crossing. Such work will likely require a flagger, so the railroad should be contacted as far in advance as possible to coordinate flagging. Note: The rule is not intended to cover immediate safety hazards or emergencies.

(b) Overcrossing Maintenance

If a bridge is covered by a Construction and Maintenance (C&M) Agreement, the state typically has the right to access railroad property for maintenance purposes, subject to requirements for notification and coordination of railroad flagging. If the work is contracted, the contractor will need to comply with any applicable requirements by the railroad, such as insurance.

300.04 Railroad Crossings

(1) Grade Separation Structure

The region should contact the HQ Railroad Liaison as early as possible for each bridge project that affects railroad facilities. Sufficient information and plans must be provided by the region to allow the railroad to review the proposal and the HQ Railroad Liaison to develop an agreement.

(2) Railroad-Highway Grade Crossings

The intersection of railroad lines with streets and highways at grade introduces the potential for conflict between trains and highway vehicles. Hazards at railroad grade crossings can often be mitigated through improvements to grade crossing warning devices, geometry, or sight distance. WSDOT is required to inspect the railroad grade crossings along state highways to ensure adequate sight distance per [RCW 47.32.140](#). Inspections also provide the opportunity to ensure the department is meeting its

responsibilities at railroad grade crossings and to prioritize the state's crossings for safety upgrades. Questions regarding WSDOT's railroad grade crossing inspection program should be directed to the HQ Railroad Liaison.

WSDOT projects that alter grade crossings (such as roadway widening, realignment, or changes to traffic control devices) require an agreement with the railroad. For coordination of projects that do NOT alter grade crossings (such as paving or maintenance-related work), the region should contact the railroad roadmaster and discuss the proposed work. (Contact information for most railroads in Washington is available at: www.wsdot.wa.gov/Freight/Rail/railroadsContacts.htm.) If necessary, the region representative should meet the roadmaster on-site to discuss the work. The HQ Railroad Liaison should be kept informed of these discussions.

Additional information concerning railroad-highway grade crossings is contained in the *Design Manual*, Chapter 1350, Railroad Grade Crossings, and Chapter 8 of the *Manual on Uniform Traffic Control Devices* (MUTCD).

(3) Temporary Railroad Crossings

Temporary railroad grade crossings are occasionally required as the result of highway construction projects or for some other access need. If a temporary crossing is needed as part of a construction project already covered by a railroad Construction and Maintenance Agreement, the HQ Railroad Liaison can, in most cases, include the crossing as part of the agreement. If, however, a temporary crossing cannot be attached to a railroad Construction and Maintenance Agreement, such rights are usually issued by the railroads as temporary crossing permits. In these cases, the Region Utilities Engineer has primary responsibility for applying for the temporary crossing permits. The HQ Railroad Liaison will assist as necessary.

(4) Crossings Along Abandoned or Out-of-Service Rail Lines

Upon notification that a rail line crossing a state highway is to be abandoned, the HQ Railroad Liaison will work with the railroad to ensure it plans to remove warning devices and tracks from the crossing. The HQ Railroad Liaison should be advised whenever a region becomes aware of rail abandonment proceedings.

Whenever rail lines are taken out of service, the railroad is responsible for removing any gate arms and removing, turning from view, or placing hoods over active warning signals at grade crossings along such lines to clearly indicate they are not in operation. In addition, it may be appropriate for the railroad to replace the crossbucks at the crossing with an R8-8 (Tracks Out of Service) sign for the benefit of vehicles that are otherwise required to stop at railroad grade crossings.

Questions regarding this chapter should be directed to the HQ Railroad Liaison at (360) 705-7271.

This page was intentionally left blank.

Government Agencies:

Chapter 5 State, Federal, Tribal, and Other Entities

- 500.01 General
- 500.02 State Agencies
- 500.03 Federal Agencies
- 500.04 Tribal Authorities
- 500.05 Railroad Companies

500.01 General

This chapter describes the role state agencies, federal agencies, tribal authorities, and railroad companies have in the Washington State Department of Transportation (WSDOT) utility work process.

The WSDOT *Design Manual* chapter on environmental permits and approvals contains procedures for acquiring necessary permits and approvals for highway construction projects. These permits are generally regulatory in nature and may apply to utility installations. The *Design Manual* does not discuss property rights relating to right of occupancy by other agencies or utilities.

500.02 State Agencies

(1) Washington State Department of Natural Resources (DNR)

DNR manages 2.6 million acres of aquatic lands, including tidelands of Puget Sound, and navigable rivers, lakes, and other waters; and 3 million acres of uplands, including forests, farms, and commercial properties. WSDOT highways cross lands and waters controlled by DNR. When highways cross waters and lands owned by DNR, DNR generally retains the right to regulate and charge for utility use of the property. DNR typically handles land transfers by County Plat Map; WSDOT right of way maps should be reviewed for concurrence with the plats. The department sends all applicants to DNR when DNR ownership is affected. WSDOT regions and the Headquarters (HQ) Bridge Division retain the right and responsibility for the approval of bridge use.

WSDOT projects and utility projects must acquire a DNR Forest Practices Permit when cutting more than 5000 board feet (approximately one log truck load) of merchantable timber.

(2) Washington State Department of Health (DOH)

DOH approves any project involving two or more domestic water connections.

(3) Washington State Department of Ecology (DOE)

DOE approves any project involving discharge of wastewater and any impacts to water quality for nearby water bodies and wetlands. DOE also regulates and requires spill prevention plans for all projects. A spill prevention plan is required for all utility installations, whether on state rights of way or not.

500.03 Federal Agencies

Contact and negotiation with federal agencies for any property rights, such as easements or rights of entry, are the responsibility of the HQ Real Estate Services Office. Requests for contact are generally initiated by the region and should include submittal of plans, appraisals, and other information necessary for negotiation.

(1) U.S. Army Corps of Engineers

Agreements with the U.S. Army Corps of Engineers (Corps) are normally entered into for dam construction and inundation of highways. These agreements are negotiated through the Utilities section of HQ Utilities, Railroad, and Agreements.

Other agreements with the Corps are handled similarly to those with the Bonneville Power Administration (see below).

Permits for Corps use or occupancy of state property are issued in accordance with [110.05](#), Local, State, or Federal Agencies.

(a) Utility Accommodation Where U.S. Army Corps of Engineers Owns Property

Where highways occupy property owned by the U.S. Army Corps of Engineers, WSDOT may only have highway operation rights and cannot grant utility accommodation rights to others. Review the highway Right of Way Plans and confer with the HQ Real Estate Services Office if questions about accommodation rights exist. If utilities locate on U.S. Army Corps of Engineers property where WSDOT has a presence but does not have utility accommodation rights, an informational document should be recorded in the Utility Franchise Permit (UFP) database. For further information, see [100.02](#), Types of Utility Accommodation Documents.

(2) U.S. Department of Energy, Bonneville Power Administration (BPA)

(a) BPA Installations With No Property Rights

Proposed crossings of the operating highway right of way by BPA transmission lines where BPA does not have a compensable or other property right requires submittal of an Application for Utility Permit or Franchise for U.S. Government Agencies (see [Appendix B](#)). All utility accommodation policies and requirements should apply. Refer to [Chapter 1](#), Utility Accommodation, for additional guidance on processing federal utility accommodation applications and other utility accommodation requirements.

(b) BPA Installations Where Property Rights Exist

When the BPA has a compensable property interest, WSDOT is required to pay the costs of any necessary relocations of existing BPA facilities to allow for the improvement of a state highway. These costs may include:

- Agreement preparation costs (if requested by the BPA).
- Preliminary engineering expenses necessary for the redesign of existing BPA facilities.
- Construction, materials, inspection, and other work necessary for the relocation of an existing facility.

(c) Funding of Relocation Expenses

Where the BPA has a property right, all costs for relocation of existing BPA facilities caused by a highway improvement project will be paid using a Trust Agreement. The Trust Agreement should establish a trust or escrow account that will fund the preliminary engineering costs (if applicable) and the construction/relocation phase of BPA facility relocation. Other payment methods may be used on a case-by-case basis if agreed to by the BPA.

(d) Reimbursable Agreement Preparation

If the BPA requests reimbursement for the preliminary engineering costs to prepare the Trust Agreement, WSDOT will prepare an actual cost Reimbursable Agreement using either a standard or nonstandard Preliminary Engineering Agreement form. Refer to [Chapter 2](#), Utility Agreements, for guidance on the preparation, processing, and approval of Preliminary Engineering Agreements.

The BPA will prepare and submit the Trust Agreement, with a signed invoice voucher, to the Region Utilities Engineer. The Region Utilities Engineer requests a UT (utility) agreement number from the HQ Division of Accountability and Financial Services and will:

- Assign that same UT agreement number to the Trust Agreement.
- Arrange to obtain the authority to perform work and funding authorization.
- Forward the Trust Agreement to [HQ Utilities](#) for approval and execution.

Upon establishment of funding and receipt of the work order authorization, the Region Utilities Engineer should ensure the voucher is prepared for processing.

The Region Utilities Engineer returns the executed Trust Agreement and voucher (advance payment trust fund) to the BPA at the same time. The BPA is informed at this time whether or not they can proceed with the work covered by the agreement.

(e) Utility Accommodation Where the U.S. Department of Energy Owns Property

Where highways occupy property owned by the U.S. Department of Energy, WSDOT may only have highway operation rights and cannot grant utility accommodation rights to others. Review the highway Right of Way Plans and confer with the HQ Real Estate Services Office if questions about accommodation rights exist. If utilities locate on U.S. Department of Energy property where WSDOT has a presence but does not have utility accommodation rights, an informational document should be recorded in the UFP database. For further information, see [100.02\(6\)](#), Informational Accommodation Documents.

(3) U.S. Department of the Interior, Bureau of Reclamation**(a) Blanket Crossing Agreement**

A “Blanket Crossing Agreement,” identified as U.S. Contract No. 14-06-100-2193 and GC-1020-B, was entered into on June 14, 1961, between the United States Department of the Interior (Bureau of Reclamation) and the Washington State Department of Transportation. This agreement outlines the responsibilities of each agency when crossing the facilities and/or right of way of the other.

(b) Purpose of the Blanket Crossing Agreement

The purpose of the Blanket Crossing Agreement is:

- To outline a procedure for handling plan approvals of construction projects wherein Bureau of Reclamation facilities or right of way are involved.
- To ensure compliance with state policy relative to the use of highway rights of way in accordance with the Utilities Accommodation Policy, which includes Chapter 468-34 WAC.
- To ensure reimbursement to the state by the Federal Highway Administration on federal-aid projects when costs are determined to be an obligation to the state.
- To ensure proper project and fund programming.

(c) Procedure for the Blanket Crossing Agreement

The working procedure for the Blanket Crossing Agreement is divided into the following two situations:

1. Project Initiated by the State

The region shall consult with the Bureau of Reclamation (and the local irrigation district, when applicable) whenever it is determined that Bureau of Reclamation facilities or property will be affected by a highway improvement. This contact can provide for negotiation of a mutually satisfactory solution for the accommodation of Bureau of Reclamation and state facilities.

a. Agreement ARTICLE 9

The region will submit construction plans, including vicinity map, plan, profile, agreement number, and details of the proposed crossing to the Bureau of Reclamation for approval in compliance with ARTICLE 9. Following the approval and signature by the Bureau of Reclamation, an original copy will be returned to the region. The region will send the original set of plans, including a signed vicinity map, to HQ Utilities for copying and distribution to the appropriate Headquarters offices.

2. Project Initiated by the Bureau of Reclamation**a. Agreement ARTICLE 9**

The Bureau of Reclamation will submit reproducible plans to the region Utilities Engineer. The region will submit the reproducible plans, along with their recommendations for approval, to HQ Utilities for review and approval. Following execution (ARTICLE 9 approval) of the plans, they will be sent to the region Utilities Engineer, who will transmit a copy to the Bureau of Reclamation.

b. ARTICLE 9 Approval Format

Approval of an item in accordance with ARTICLE 9 of the Blanket Crossing Agreement will be by affixing the appropriate signature to the vicinity map for the construction plans in a form similar to the following:

ARTICLE 9 APPROVAL

Approved By: _____ Date: _____

Title: _____

c. Approval Format Utilization

The above ARTICLE 9 approval format is used by both the WSDOT and USBR.

(d) Title to and Maintenance of Crossing Facilities**1. Project Initiated by the State – Agreement ARTICLE 16**

Upon completion of a project involving the Bureau of Reclamation, the Region Construction Engineer will sign a copy of the “as built” construction plans. The region Utilities Engineer will transmit a copy to the Bureau of Reclamation for its approval in compliance with ARTICLE 16.

Approval by the Bureau of Reclamation will consist of affixing the appropriate signature to the plans and returning them to the state. The region will retain a copy and the region will send a copy to HQ Utilities for further processing.

2. Project Initiated by the Bureau of Reclamation – Agreement ARTICLE 16

Upon completion of the project, the Bureau of Reclamation will submit “as built” plans to the region Utilities Engineer, who will transmit a copy to HQ Utilities for signature by the State Design Engineer, in accordance with ARTICLE 16 of the Blanket Crossing Agreement. Following execution, a signed copy will be sent to the region Utilities Engineer, who will transmit a copy to the Bureau of Reclamation.

3. ARTICLE 16 Approval Format

Approval of an item will be by affixing the appropriate signature (per ARTICLE 16) to the “as built” construction plans in a form that includes the following information:

The following notes should be affixed to all copies of the “As Built” construction plans. Use a format similar to the following:

United States Ownership and Maintenance (ARTICLE 16)

UNITED STATES OWNERSHIP AND MAINTENANCE

All pipe in pipelines or culvert crossings, transitions, control and delivery structures, and/or protection that may be a part of the inlet or outlet of a culvert pipeline, and all other protection, and all waterways installed for the benefit of the United States, including the continuation of such features through WSDOT rights of way.

UNITED STATES OF AMERICA

Accepted By: _____ Date: _____

Title: _____

State of Washington Ownership and Maintenance (ARTICLE 16)

STATE OF WASHINGTON OWNERSHIP AND MAINTENANCE

All (*bridges, including footings, piers, abutments, approach fills**) road surfacing, road right of way, and all embankments, ballast, and fills supporting a road.

STATE OF WASHINGTON, Department of Transportation

Accepted By: _____ Date: _____

Title: _____

*Use the Italic text within the parentheses for bridge projects

(4) U.S. Department of Agriculture, Forest Service

(a) Memorandum of Understanding, No. NFS 00-MU-11060000-040

The Memorandum of Understanding (MOU), *Highways Over National Forest Lands* (WSDOT Publication M 22-50), executed May 31, 2001, defines how WSDOT and the U.S. Department of Agriculture, Forest Service, handle certain issues on state highways that are located within Forest Service lands. Issues such as coordination; planning; highway maintenance and construction; signage; and access are discussed in the MOU.

The MOU also defines how WSDOT will communicate and inform the Forest Service when third-party utility installations are proposed within the highway right of way that occupies Forest Service lands. This MOU is currently being rewritten; always see the latest adopted document.

(b) Forest Service Opportunity to Review and Comment

WSDOT is obligated to provide the Forest Service an opportunity to review any Utility Accommodation Applications that fall within Forest Service lands. Refer to [Figure 500-1](#) for Forest Service boundary intersections on state highways.

Under the terms of the MOU (above), the Forest Service has 30 days from the receipt of the draft Utility Accommodation Application (see [Appendix B](#)) to comment on the proposed installation, with a recommendation for approval or reasons for denial of the utility installation request. After 30 days, if WSDOT has received no comment from the Forest Service, the department may grant the utility installation request.

U.S. Forest Service Areas										
State Route	RRT/RRQ Identifier	Begin SRMP	B	End SRMP	:	State Route	RRT/RRQ Identifier	Begin SRMP	B	End SRMP
002		34.74		48.48	:	113		2.00		6.06
002		48.99		98.88	:	119		9.22		10.93
012		128.40		128.48	:	123		0.00	B	2.56
012		151.15		179.14	:	131		0.00		0.01
020		102.23		110.98	:	141		29.25		29.30
020		139.10		181.28	:	165		0.00		3.44
020		210.05		214.85	:	207		0.00		4.38
020		292.67		294.88	:	395		253.32		253.48
020		312.83		335.42	:	395		256.45		256.95
020		378.60		388.46	:	395		260.87		262.80
020		398.63		400.56	:	395		264.59		270.26
021		147.96		152.58	:	410		69.21		100.11
031		15.12		26.79	:	542		32.89		57.26
090		41.04		52.72	:	542	COMTBAKR	54.60		54.97
097		152.34		163.72	:	706		10.28		13.64
097		163.72		180.88	:	906		0.00		2.65
097	AR	208.08		208.15	:	906	SPHYAK	2.55		2.98
097	AR	218.30		219.66	:	971		1.44		1.71
097	AR	224.53		224.96	:	971		1.75		2.04
101		118.15		125.52	:	971		3.74		3.77
101		208.88		219.21	:					
101		236.28		240.08	:					
101		298.01		300.90	:					
101		301.96		305.37	:					

U.S. Forest Service Boundary Crossings

Figure 500-1

(c) Disclosure of Forest Service Requirements

The MOU also obligates WSDOT to inform the utility that either a Forest Service Special Use Permit or an easement is required by the utility. However, according to the terms of the MOU, the department is under no obligation to enforce this requirement.

1. Special Provision

The terms of the MOU require that all approved utility accommodation documents that allow for encroachment upon Forest Service lands must include the following Special Provision:

Approval of this utility permit or franchise is contingent upon the applicant utility obtaining an approved USDA Forest Service Special Use Permit and/or easement for use of National Forest System land prior to the construction of the proposed utility installation.

(d) Forest Service Requirements

In addition to WSDOT obligations, the MOU obligates the Forest Service to withhold issuance of a Forest Service Special Use Permit or easement until the applying utility has an approved Utility Accommodation Application issued by the department.

500.04 Tribal Authorities

When highways exist on tribal lands, it must be determined whether there are any restrictions on WSDOT's ability to allow utility accommodations. Researching highway grants may be quite difficult since they could be by letter, Bureau of Indian Affairs (BIA) agreement, or permit, or by more formal documentation, such as easements and quitclaim deeds. If no restrictions are found, WSDOT may process utility accommodation documents in accordance with this manual.

Where rights are reserved by tribal authorities or where a right of way conveyance cannot be established, lands belonging to federally recognized Indian tribes are acknowledged to have sovereign immunity. In these areas, the Region Utilities Engineer should file an informational utility accommodation document. For information, see [100.02\(6\)](#), Informational Accommodation Documents.

Indian tribes have rights of consultation for historical and archaeological purposes beyond the specific tribal boundaries. Highway projects and major utility installations may become involved in tribal archaeological studies outside tribal boundaries. For more information, see the GIS site, Indian Reservations of Washington State (www.wsdot.wa.gov/mapsdata/geodatacatalog/Maps/24k/DOT_Cartog/federal/IndianRes.htm), WSDOT Executive Order: E 1025.00, "Tribal Consultation," and WSDOT's Tribal Liaison for further guidance.

Tribe	County
Chehalis Confederated Tribes	Grays Harbor and Thurston
Colville Confederated Tribes	Okanogan and Ferry
Cowlitz Indian Tribe	Cowlitz and Clark
Hoh Tribe	Jefferson County
Jamestown S'Klallam Tribe	Clallam
Kalispel Tribe	Pend Oreille County
Lower Elwah Klallam Tribe	Clallam County
Lummi Tribe	Whatcom County
Makah Tribe	Clallam County
Muckleshoot Tribe	King County
Nisqually Tribe	Thurston County
Nooksack Tribe	Whatcom County
Port Gamble S'Klallam Tribe	Kitsap County
Puyallup Tribe	Pierce County
Quileute Tribe	Clallam County
Quinault Nation	Grays Harbor
Sauk-Suiattle Tribe	Skagit
Shoalwater Bay Tribe	Pacific County
Skokomish Tribe	Mason County
Snoqualmie Tribe	King
Spokane Tribe	Stevens County
Squaxin Island Tribe	Mason County
Stillaguamish Tribe	Snohomish
Suquamish Tribe	Kitsap County
Swinomish Tribe	Skagit County
Tulalip Tribes	Snohomish County
Upper Skagit Tribe	Skagit
Yakama Nation	Yakima and Klickitat

Indian Tribes in Washington State

Figure 500-2

500.05 Railroad Companies

Where state highways are constructed on railroad right of way, WSDOT has acquired an easement or encroachment right. These rights are normally limited to highway operational needs and do not grant the department a right to allow utility occupancy. If utilities locate on railroad property where WSDOT has a presence but does not have utility accommodation rights, an informational document should be recorded in the Utility Franchise Permit (UFP) database (see [100.02\(6\)](#), Informational Accommodation Documents).

In reviewing a utility accommodation document application, examine highway Right of Way Plans where highways are in close proximity or cross the railroad right of way. Consult the HQ Real Estate Services Office if the highway rights are in question.

When WSDOT needs a wire or conduit crossing permit from a railroad, consult with the HQ Railroad Liaison. The permits are generally acquired by region staff. For further guidance, see [Chapter 3](#), Railroads.

- 600.01 General
- 600.02 Schedules, Goals, and Strategies
- 600.03 Early Utility Identification
- 600.04 Coordination, Cooperation, and Communication
- 600.05 Roles and Responsibilities
- 600.06 Cost Responsibility and Recovery
- 600.07 Coordination Milestones
- 600.08 Project Initiation: Project Design Notification
- 600.09 Geometric Review (30%)
- 600.10 Subsurface Utility Engineering (SUE)
- 600.11 Preliminary Engineering Agreements
- 600.12 General Plans Review (60%)
- 600.13 Preliminary Contract Review (90%)
- 600.14 Preadvertisement
- 600.15 Design/Construction Utility Relocation Facilitation
- 600.16 Project Award and Construction
- 600.17 Developer Projects and Utility Relocation

600.01 General

The Washington State Department of Transportation's (WSDOT's) Region Utilities Offices are responsible for the oversight and control of utility installations within the operating highway right of way. During the project development and construction phases, Region Utilities Offices serve as subject matter experts regarding utility installation requirements. They provide organizational contact and coordination support between utility organizations and highway project managers as well as utility agreement- and service agreement-writing services. In addition, Region Utilities Offices are responsible for providing guidance and assistance to project development staff as they address utility issues relating to their projects.

600.02 Schedules, Goals, and Strategies

The project team should approach utility relocations systematically during the development phase of highway projects. Establishing a Utility Relocation Plan early in the project development process that includes goals, strategies, and expected milestones facilitates appropriate and timely utility conflict resolution throughout the process. It also serves as a template for measuring the progress and success of utility conflict resolution early in the project and helps prioritize and focus resources in later project stages.

The primary goal of any project utility conflict should be to relocate the utility before construction begins. However, this is often not possible when utility relocation is dependent upon the acquisition of right of way or the construction of a highway element such as a utility conduit on a bridge, major earthwork, or environmental permitting. Regardless of the utility conflict, solutions should be identified and goals established as early as possible for each conflict resolution.

(1) Schedules

It is the Region Utilities Engineer's responsibility to be sure that utility companies understand the project schedule. The Region Utilities Office will ensure utilities provide the Project Engineer with necessary, reasonable utility relocation schedules. Any possibility of schedule delays needs to be communicated to the Project Engineer for resolution.

(2) Goals

Involvement in initial project meetings such as Pre-Design meetings provides opportunities to work with various project stakeholders to discuss utility conflict goals and strategies. Some projects will have few utility conflicts and will require little effort to resolve them. Other projects will have extensive utility conflict resolution issues and will require more involvement and effort by the Region Utilities Office. Establishing conflict resolution goals and strategies early will also assist in forecasting the resources that will be necessary to meet those goals.

(3) Strategies

Developing an effective strategy to deal with various utility elements helps to facilitate the overall conflict resolution objective. As mentioned above, strategies are the means by which to achieve the goals.

- What needs to happen in order to achieve a specific utility conflict resolution?
- Does a strategy include advancing certain design work to minimize or avoid a utility conflict?
- Will changing a design element minimize the conflict?
- Does the strategy benefit the state?

Many variables may be present and available to influence overall goals and strategies and will differ considerably between projects. Other issues that may influence utility conflict resolution strategy include the following:

- Multiple utilities
- Right of way limitations
- Project schedules
- Easement rights
- Agreements

The Region Utilities Office is responsible for all utility issues within the right of way and should be available for assistance and to provide input regarding utilities. Developing an effective utilities strategy involves the consideration of all variables within a project. A good strategy represents a "contingency approach" that can offer the greatest and most efficient project benefit for resolution of utilities conflicts.

600.03 Early Utility Identification

The Region Utilities Office is responsible for acquiring existing utility information. Early recognition of utilities located within the project limits is crucial to the overall success of a highway improvement project. Identification can come from a variety of sources available to the Region Utilities Office and may include various levels of detail. These sources include:

- WSDOT utility databases.
- Region Utilities Office hard copy files.
- Region utility contact lists.
- Utility company as-built records.
- Subsurface Utility Engineering (SUE) investigation.
- Site visits.
- SR View program.

Virtually all highway improvement projects will involve some type of a utility facility within the highway right of way. Utility conflicts should be expected and anticipated. Each utility facility within the project limits has the potential to influence the project; therefore, consider utility issues as early as possible in the project development process. This early recognition will help avoid schedule and budgetary pitfalls in later stages when the project is more established and recovery from unexpected project redesign or utility relocation coordination conflicts can be more difficult to overcome.

Careful and diligent research should identify existing utility facilities and their general locations. If not already identified, early research should also determine any compensable property rights an existing utility may possess. Since compensable rights may have a budgetary impact on the project, it is prudent to identify compensable interests as early as possible in the project development phase. Refer to [Chapter 2, Utility Agreements](#), for detailed information regarding utilities with compensable property rights.

600.04 Coordination, Cooperation, and Communication

Utility coordination often involves working with multiple utility representatives to:

- Identify existing utilities within project limits.
- Resolve conflicts between those utility facilities and various project elements.

Coordinating between affected utility owners and the project development team can represent a significant effort by the Region Utilities Office. This effort should include vital design or construction personnel who are familiar with the project as well as region support groups such as Real Estate Services or the Environmental Office. Having the utility owner's cooperation is also very important. Note that project utility coordination efforts typically focus on preliminary project design issues; however, it is common for coordination to carry over into construction.

Early and continuous communication between affected utilities and WSDOT helps avoid miscommunication and minimizes the potential for project delays. Effective coordination requires both cooperation and effective communication. Fostering a productive environment in which the affected utilities and the department can exchange mutual concerns and establish realistic objectives can yield mutually beneficial results. Avoid setting unrealistic expectations that will be difficult to achieve. Successful facilitation of utility conflict resolution issues involves an understanding that both parties have requirements that need accommodation.

(1) Utility Engineering Needs

WSDOT should not underestimate utility relocation needs. The relocation of even a short section of buried utility line or a small number of utility poles can easily result in a utility construction project whose scope is larger than anticipated by the department. This may in turn have a negative effect upon the project delivery schedule. Provide utility owners enough time to plan and engineer utility relocations; budget funds; comply with environmental and permit requirements; negotiate real estate transactions; order and receive materials; and schedule construction crews. Utility companies often must advertise and award bids for relocation work. As with other construction issues, the project development team should incorporate utility relocation requirements into the overall project schedule to avoid project delays and provide a realistic project schedule.

(a) Highway Project Schedule and Design Changes

The effects upon utility relocations should also be taken into account when considering highway improvement project scheduling and design changes. Design changes that affect expected relocations add time and expense to utility owners' relocation plans. Maintain regular communication throughout the project development process to ensure WSDOT and affected utilities meet the project's scheduled Ad date.

(2) Communication

Best Practice

Establish regular coordination meetings with utilities to discuss project status. These meetings should provide a forum for open two-way exchanges of critical information. They also provide an opportunity for Project Engineers and designers to manage the project and react to issues as they are identified. The intent should also be to convey WSDOT's expectations concerning project timelines and utility accommodation requirements.

The role of the Region Utilities Office may vary between regions. For those regions using different Design and Construction Project Engineers, the role is to bridge the critical gaps between the design and construction phases. Therefore, the Region Utilities Office must be involved in both project phases.

Other project considerations include:

- Oversight of advance utility relocation efforts.
- Establishing schedules and timelines for all utility relocation work.
- Permitting and accommodations with the Region Utilities Office.

- Design changes, project schedule delays, and shelved projects.
- Tracking necessary right of way acquisitions.
- Additional required environmental permitting beyond that which may be required for the project.

(3) Documentation

To ensure success, approach the utility relocation process with a cooperative attitude. Clearly document all phases of the utility relocation process and WSDOT's efforts to work with and accommodate utility owners. Maintain all correspondence, diaries, plans, meeting notes, and other information in an organized manner. These documents should clearly illustrate and support the steps the department has taken to work with utility owners. For future reference, regions should establish a filing system to maintain all documentation related to utility relocations.

600.05 Roles and Responsibilities

Responsibilities for utility relocations vary between regions and projects and within each phase of the project development and construction processes.

(1) Region Utilities Office

The Region Utilities Office should be available to assist project development staff in creating a strategy to identify and coordinate the relocation of utilities located within the project limits.

(a) Unknown or Undocumented Utilities

The Region Utilities Office may not have access to information about every utility installation located on the project; unknown and undocumented utilities may exist. Further, utilities may exist on private easements or owned property outside the existing right of way where additional right of way acquisition is required for the improvement project. By initiating early communication about utility issues, the Region Utilities Office can work with project designers to obtain as much utility information as possible as early as possible and avoid unnecessary delays later in the project development process.

Once utilities have been adequately located, the project development staff should determine the extent of utility impacts or conflicts to the project. The Region Utilities Office and Region Real Estate Services Office should help to assess where the responsibility lies for the associated relocation costs. The Region Utilities Office will also work to communicate the impacts to the affected utilities. The Region Utilities Office staff should work to provide benefit to the project design team and keep abreast of all changes and communications that take place with utility owners and the project design team.

It is important to recognize that project development staff has a responsibility to communicate project impacts to utility owners. However, the Region Utilities Office should take a proactive role in project utility issues and, as subject matter experts, should be involved in the project development process whenever necessary.

(2) Project Engineer's Office: Design Team

Project designers are responsible for project design development and implementation, including coordination and resolution of utility conflicts within the project limits. The design team in the Project Engineer's Office identifies potential conflicts and works to resolve those conflicts by coordinating utility relocation efforts to eliminate potential project delays or to redesign portions of the project to avoid utility conflicts. In order to avoid costly utility relocation delays during the construction phase of the project, regular and meaningful coordination with the project design team is essential.

(3) Project Engineer's Office: Construction Team

The construction team in the Project Engineer's Office maintains overall administrative QA/QC oversight for the construction phase of projects. The Project Engineer is responsible for bridging the gap between utility owners and WSDOT's construction contractor.

(4) Utility Owners

The owner of a utility installed within the operating highway right of way has an obligation to contribute to the project design and delivery process and relocate its utility to a location at a time that is mutually agreeable and beneficial to both WSDOT and the utility owner. However, utility owners also have a reasonable and justified expectation that they will be kept informed of pertinent project details so they can schedule the necessary time and resources to meet their relocation needs.

600.06 Cost Responsibility and Recovery

Ultimately, the taxpayer/ratepayer pays the costs for necessary utility relocations. It is for this reason that utility relocations and the redesign expenses incurred to avoid utility relocations should be a shared cost, depending on the circumstances surrounding the utility conflict.

Addressing utility impacts early in the project development process can significantly reduce costs and project delays associated with utility relocations.

(1) Determination of Cost Responsibility

Impacted utilities generally fall into one of the following four categories. These categories dictate whether the utility or WSDOT will be required to pay for work associated with any relocations or design cost recovery efforts. Refer to [Chapter 8, Reimbursement](#), for additional information on cost recovery policies.

(a) Utility Occupation by Permit or Franchise

Most installed utilities are authorized to occupy the operating highway right of way by a utility permit or franchise, generically referred to as an accommodation document. Accommodation documents are binding contracts between WSDOT and a utility that define the circumstances of the installation of the utility's facilities within state right of way.

Utilities installed under an accommodation document have no compensable property rights. In this case the utility is responsible for the relocation's costs or additional design costs incurred by WSDOT to avoid relocation.

(b) Utilities Located Within State Right of Way by Easement

Utilities are sometimes located within the operating highway right of way by easement. Easements generally, but not always, provide a compensable property right to the utility. Carefully screen identified easements to determine the allowable provisions of the easement and what compensable property rights the easement document may grant.

WSDOT is responsible for the costs associated with relocation or project redesign of utilities with easements granting a compensable property right. Early identification of compensable property rights is vitally important. Ideally, these rights should be identified in the scoping phase, as those costs often have a significant financial impact on project budgets.

(c) Utilities Located Outside State Right of Way

In some cases, proposed highway improvements require the purchase of additional right of way to accommodate the highway project. Often utilities exist outside of, but adjacent to, the existing highway right of way in the area of the new additional right of way acquisition. The utility may own the property fee simple or may have a property right upon the adjacent property. In conjunction with title research, the Project Engineer's Office should examine title reports for evidence of an existing utility property right or other easements both inside and outside the existing right of way and verify the extent of the easement property right. If the property right is valid, WSDOT has the responsibility to pay for any relocation costs as well as replacement of or compensation for the easement or property right.

For detailed guidance on property acquisition issues, contact the Region Real Estate Services Office. If additional rights of way are needed for the project, Real Estate Services may need to clear the right of way of all encumbrances. Quitclaim deeds will need to be prepared, signed, and recorded to extinguish an easement or to exchange easements.

Property acquisition requires considerable time—sometimes six months or more for each parcel. Early communication between the Project Engineer's Office, Region Utilities Office, Region Real Estate Services Office, and utility owner is vital to avoid project delays.

(d) City Utilities on City Streets

When a highway project impacts a city street in which city utilities are located, WSDOT is responsible for the relocation costs. When city utilities are located within state limited access areas, the city is responsible for the relocation costs of its facilities.

(2) Utility Agreements

If a property right is verified, payment for relocation costs will require a utility agreement. The agreement should detail the conditions of payment and, in most cases, should document specific utility design criteria. Regardless of circumstances, before any utility work is completed, an agreement between the utility and WSDOT is required that defines costs, circumstances, rights, and responsibilities for necessary relocation work. Refer to [Chapter 2, Utility Agreements](#), for detailed information on preparing various types of utility agreements.

600.07 Coordination Milestones

Coordination responsibilities for utility relocations vary within the project team and during each phase of project development and construction. Important milestones for utility coordination generally include the following:

- Scoping Estimate
- Project Design Notification
- Geometric Review
- General Plans Review
- Preliminary Contract Review
- Plans, Specifications, and Estimates (PS&E) Final Contract Review
- Advertisement and Award
- Project Construction

Each milestone provides an opportunity for more defined and specific coordination with existing utilities that could affect project delivery schedules (see [Figure 600-1, Project Utility Coordination Process](#)).

600.08 Project Initiation: Project Design Notification

The project design team should request utility location information from the Region Utilities Office during the preliminary development of the project. Upon receipt of the Project Design Notification, the Region Utilities Office should make every effort, based on available information, to determine which utility owners have facilities located within the limits of the WSDOT project. The Region Utilities Office should send letters to all identified utility owners requesting utility as-built information and data. The letter should also request receipt of this information within a reasonable period after the date of the request. Forward as-built information to the Project Engineer's Office upon receipt from the utility for inclusion in project plans. The Region Utilities Office should document efforts to obtain utility as-built information.

600.09 Geometric Review (30%)

Once the project development process is approximately 30% complete, the design team at the Project Engineer's Office arranges a Project Design Overview meeting. Among other discussions, the meeting should identify utility owners impacted by the project. Utility owners should be prepared to update and verify the location of their utilities and express any concerns or suggestions they may have regarding utility relocations.

Utility conflicts should be sufficiently identified and any additional investigative engineering determined by the Geometric Review. Start or continue to develop the Subsurface Utility Engineering (SUE) Level B, C, and D investigations as needed to sufficiently identify and locate existing utilities within the project footprint. The Project Engineer's Office and utility owners should also discuss required relocation phasing and the needs and responsibilities for obtaining any utility-related environmental documentation and permitting.

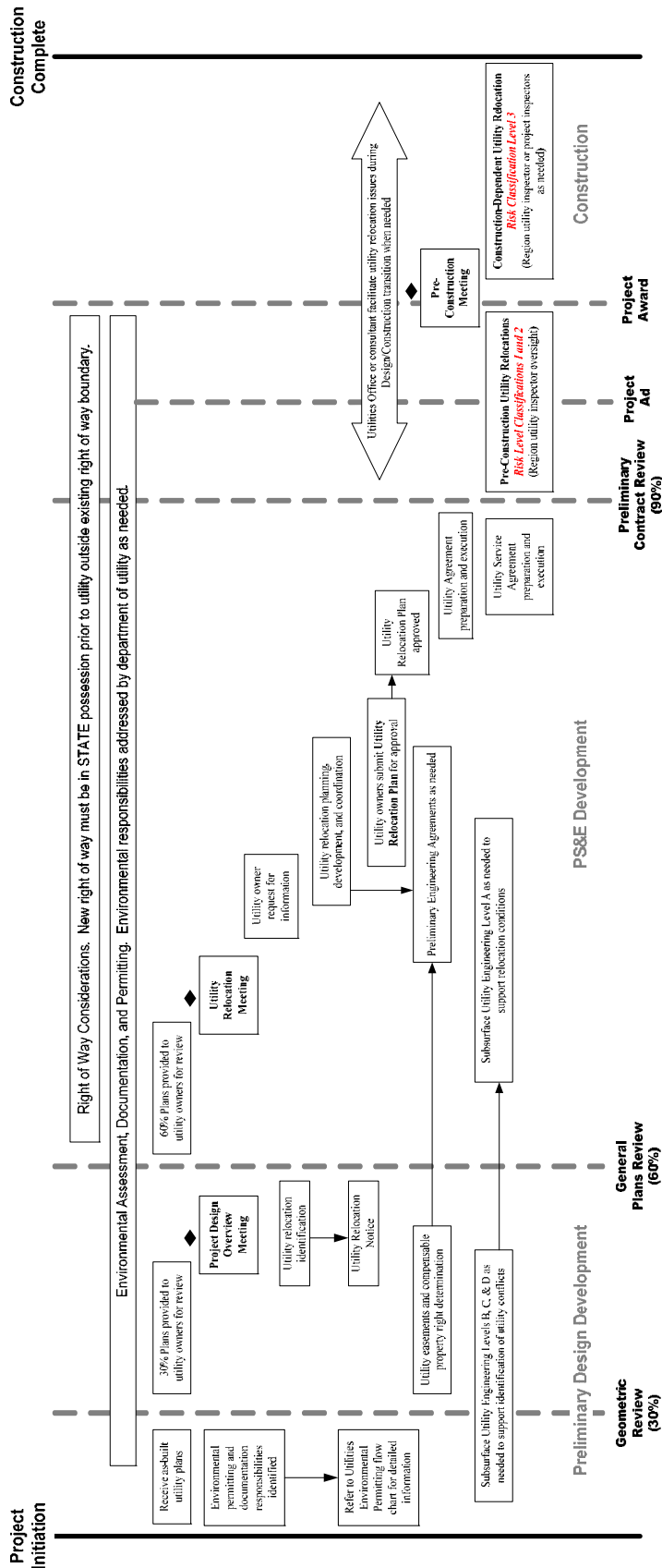

Project Utility Coordination Process
Figure 600-1

As the project design continues to develop and evolve between 30% and 60% plan completion, continue to address utility impacts and keep utility owners informed as issues arise. Continue to coordinate with the Region Real Estate Services Office on right of way acquisitions, and provide information (as appropriate) to the utilities to assist them in the process of acquiring property or easements outside state right of way on which to relocate if they are not being placed on a permit or franchise.

(1) Project Design Overview Meeting

The Project Engineer's Office and/or the Region Utilities Office should invite utility owners to a Project Design Overview meeting. The purpose of the meeting will be to explain the project's scope, expectations, and schedule. Provide utility owners with copies of the Geometric Review and project development schedule prior to the meeting for review and consideration.

The general goal of the Project Design Overview meeting should be to identify environmental issues, real estate acquisitions needs, erosion control concerns, Control Zone Guidelines compliance, and other issues or constraints related to the project. During the meeting, make a good faith effort to identify and evaluate preliminary opportunities to avoid or minimize utility conflicts within the project limits.

(a) Utility Owner

When invited to attend the Project Design Overview meeting, WSDOT should ask utility owners to provide:

- Verification of the locations of their respective utility facilities shown on the Geometric Review and any additional or updated information with respect to those facilities.
- An overview of project concerns, relocation issues, property rights, utility facility requirements, utility installations needed for future expansion, and schedules for utility preliminary engineering, utility relocation, and environmental compliance issues or needs.

(b) Project Design Office

WSDOT should provide the following information:

- Identify utility potholing needs.
- In consultation with the Region Utilities Office, determine the need for Subsurface Utility Engineering corresponding to Construction Institute/ASCE Standard CI/ASCE 38-02 – *Standard Guidelines for the Collection and Depiction of Existing Subsurface Utility Data*.

(2) Utility Identification: Subsurface Utility Engineering (SUE)

Sometime during the project development process, typically around 30% plan completion, the Project Engineer's Office, Region Utilities Office, and SUE consultant (if used) should meet to discuss subsurface utility identification needs and make appropriate arrangements for SUE investigations. SUE investigation and coordination includes the following:

- The Project Engineer's Office continues project development beyond the Geometric Review.

- As the project design is developed, areas of utility conflict and potential utility relocation are narrowed down.
- Aboveground utility objects that require Control Zone Guidelines compliance are listed on the project Utility Object Relocation Record (UORR).
- The Project Engineer's Office sends project UORRs and the Geometric Review showing utility conflict areas to the Region Utilities Office for review and approval prior to transmittal of the Utility Relocation Notice to affected utility owners.
- The Project Engineer's Office will send the Region Utilities Office a listing of environmental document approvals required by governmental agencies and the expected schedule for WSDOT permit applications that may be affected by utility relocations.

(3) Utility Relocation Notice

Once utility conflict redesign options have been eliminated and necessary utility relocations identified, the Region Utilities Office is responsible for the following:

- Review existing utility facility conflict area.
- Check UORR calculations.
- Send Utility Relocation Notices to each affected utility owner. Notices should include project plans identifying existing utility locations; UORRs for surface utilities; a listing and application schedule for governmental approvals for the highway project; project milestone dates; and an approximate date for Utility Relocation meetings.
- Begin the development and negotiation of Utility Preliminary Engineering Agreements, if appropriate.

(4) Environmental Permitting and Documentation

Discuss responsibility for acquisition of any necessary environmental documentation and permitting with the Project Development Engineer and the utilities as early in the design process as possible. Environmental requirements will vary between projects. Ensure Project Development Engineers are aware of the need for environmental documentation and permitting compliance for utility relocations. Address and verify that construction issues and the responsibility for obtaining environmental permits and documentation have been addressed.

If a utility relocation within project limits is necessary during construction, project environmental permitting for utility relocations may be included within WSDOT's environmental permitting package. This avoids delays to the project schedule related to difficulties a utility may experience acquiring separate environmental permitting.

It should be kept in mind that WSDOT assumes a certain amount of risk for environmental violations whether utilities obtain their own permitting or they are included within the department's environmental documents. Further, utility owners' priorities are not always the same as WSDOT's; therefore, utilities may not strive to obtain environmental permitting to meet the department's project schedule.

Advantages to including utility relocation work under WSDOT's environmental documentation and permitting include the following:

- WSDOT maintains control over the documentation and permit approval process, reducing opportunities for conflicting project work descriptions being presented to the approving authorities.
- It eliminates potentially redundant permit approval processes.
- It reduces the potential for project delivery delay if the utility is unable to obtain documentation and permits on time to meet the construction schedule.

Disadvantages to including the utilities under WSDOT environmental permits include the following:

- WSDOT is responsible for managing the utility's activities on the project site and may need to add staff to manage this aspect.
- Permit conditions for utilities may be more stringent and impact WSDOT work plans, or WSDOT conditions may be more stringent and impact the utility's work plan.
- WSDOT, as the permit holder, is responsible for fines to utilities.
- It creates delays to the Project Design Office's completion of plans; it will need the Utility Relocation Plans, which typically are being prepared until the General Plans Review.
- It creates delays to WSDOT environmental permits due to Utility Relocation Plans not being submitted until after the General Plans Review.
- Added time is needed for WSDOT to review utility environmental documents and plans for inclusion in project plans.

(a) **Environmental NEPA/SEPA Documentation and Biological Assessments**

To assist WSDOT in including the utility work in the department's National Environmental Policy Act (NEPA), State Environmental Policy Act (SEPA), and Biological Assessment (BA) approvals, early determination of relocated utility configuration and installation methods should be included:

- For the highway project.
- When work is occurring in areas for which WSDOT will be clearing the permit process for NEPA/SEPA.
- In critical and sensitive areas.

By including utility relocation work in the highway project's environmental process, designers can realize considerable time savings later in the design process. When potential utility modifications and relocations are included for environmental review and documentation at the same time as the rest of the highway project, the regulatory agency considers utility relocation efforts covered under WSDOT's environmental process and the NEPA and SEPA documentation. In addition, WSDOT may be able to avoid cost overruns during actual construction that might otherwise occur due to utility delays.

Consult with the Region Environmental Office for detailed guidance on determining the eligibility of a utility to be included under WSDOT's environmental documentation.

(b) Determining Permitting Coverage

Determine permitting responsibilities between WSDOT and a utility on a project-by-project basis. Responsibility for obtaining environmental permits should be determined early in the design process and documented to ensure all parties are aware of their roles and responsibilities. When utilities must obtain environmental approvals independent of WSDOT, ensure there is good communication with the utility and complete understanding of the needs and requirements. Regular communication will assist in avoiding confusion and miscommunication that can lead to project delays later.

(c) WSDOT-Acquired Environmental Permitting

Consider the following factors when determining whether utility relocations can be included under WSDOT's environmental package:

- Can both the utility and WSDOT operate under the same type of permit and permit conditions?
- Is relocation work occurring in areas where WSDOT will be clearing the NEPA/SEPA process?
- Are utilities able to inform WSDOT of construction methods and processes so the department can include that information in the project environmental permit application?
- Can coverage under WSDOT's permits accommodate the timing and sequence of relocation work with the scheduled highway work?
- Is there a relatively low risk of noncompliance? (Since environmental permits are under WSDOT's name, the department is the responsible agency.)
- Are utilities willing and able to commit to performing their relocation work under the required permit conditions and in an environmentally sensitive manner?
- Is WSDOT able to ensure utilities have copies of, understand, and are willing to work under the conditions set forth in the environmental permits, regardless of whether the utility is working prior to actual highway construction start or is working concurrently with the highway construction?

(d) Relocation Under WSDOT Environmental Permitting

If permit coverage for utility work is going to be included in WSDOT's permit package, the project offices should work closely with the utility to gain a thorough understanding of the utility's relocation needs and construction methods. Issues that require clarification include:

- Is the utility relocation dependent upon highway construction phasing?
- Does bridge construction need to be completed for the utility relocation to be completed? If so, are there temporary relocation issues? Is there a cut or fill section that needs to be built before the utility can be relocated?

- Is there a construction method that involves special contamination containment methods?
- Are there any public safety issues (such as those associated with combustible materials)?
- Are there industry-specific permits that need to be obtained (such as those associated with the petroleum industry)?

(e) **Utility-Acquired Environmental Permitting**

Consider the following factors to determine whether the utility should acquire environmental permits independently:

- The utility relocation is scheduled in advance of the construction or outside the project limits.
- Environmental documentation necessary for the utility work differs from the environmental documentation requirements for the work being done by WSDOT.
- Specialized work methods for the utility relocation exist that WSDOT is not able to sufficiently outline in its permit application.
- Utility relocation has substantial impacts and mitigation because utility upgrades (betterments) are included in the relocation work.
- There are times when utility compliance issues would jeopardize or delay the issuance of the WSDOT project's environmental permits.
- Environmental permits are required solely for the utility work and not for WSDOT's project.

When the utility owner is responsible for obtaining environmental permits independent of WSDOT's environmental permitting effort, the department should maintain regular contact with the utility to ensure the process is moving forward. Refer to [Figure 600-2, Project Delivery Utility Relocation Environmental Permitting Process](#), for a graphical representation of the process.

600.10 Subsurface Utility Engineering (SUE)

The Construction Institute and the American Society of Civil Engineers have established the reference, CI/ASCE 38-02 – [Standard Guidelines for the Collection and Depiction of Existing Subsurface Utility Data](#), which WSDOT has adopted.¹

To minimize the risk of utility conflicts with contract work, a project design team should be certain that existing utilities—active, abandoned, and unknown—are identified so that the locations of these individual utilities are recorded with appropriate assurance and reliability. The following guidelines are based on quality levels of utility information presented in the ASCE Standard. These guidelines will allow WSDOT project teams to develop strategies to reduce the risk of utility conflicts with construction activities by appropriately identifying the quality level required for a given construction activity. All project team members must understand how the utility data for each quality level are obtained, and they should determine the level required for the planned design and construction activities.

¹ WSDOT personnel can obtain this publication from the Headquarters Utilities Specialist

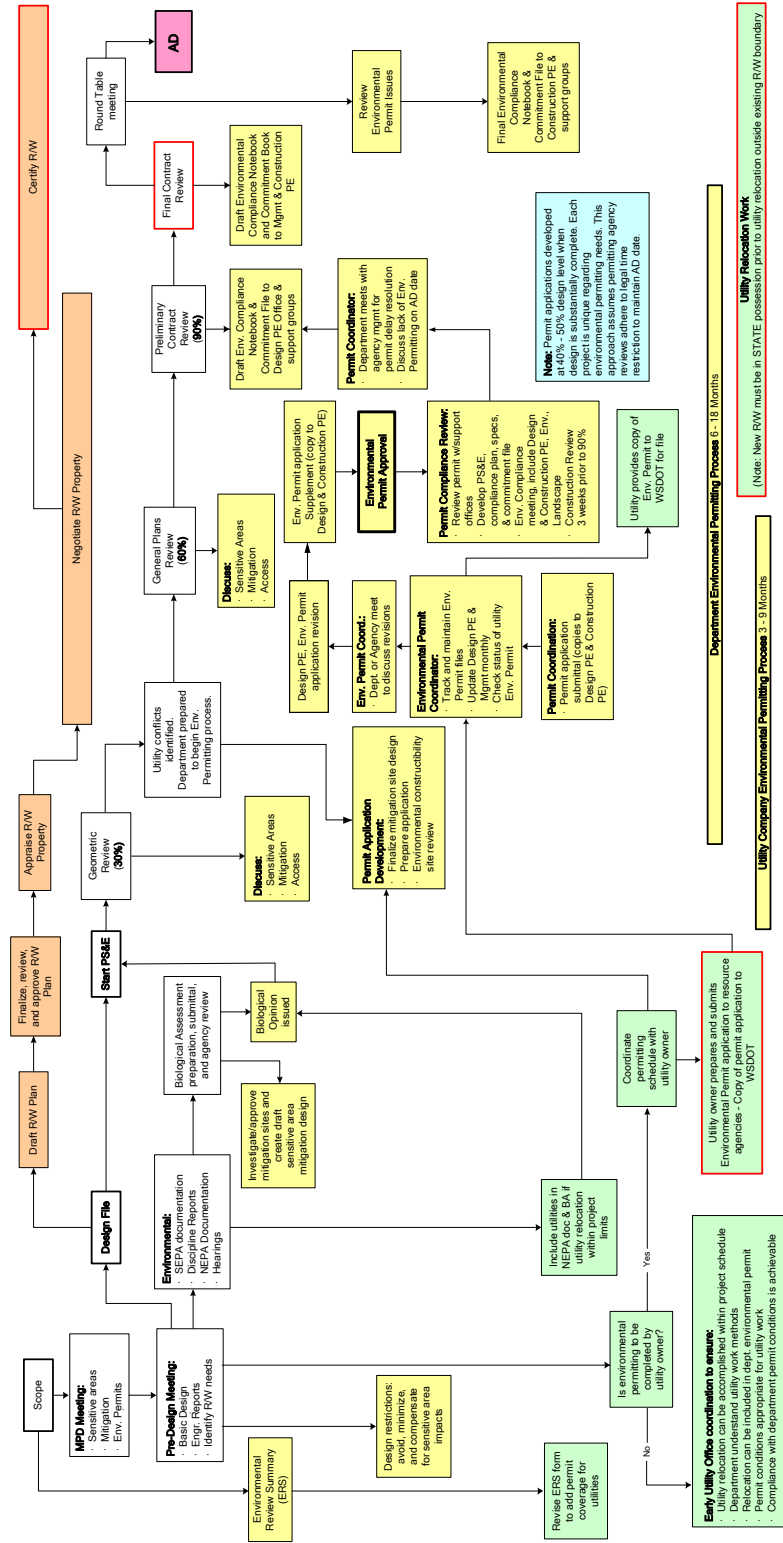

Project Delivery Utility Relocation Environmental Permitting Process
Figure 600-2

(1) SUE Quality Levels

(a) Quality Level “A” (QL-A): Locating

The precise horizontal and vertical locations of utilities are obtained by the actual exposure and subsequent measurement of subsurface utilities at specific points. Minimally intrusive excavation equipment is typically used to decrease the potential for utility damage. Precise horizontal and vertical positions, as well as other utility attributes, are shown on the final work product. Accuracy is typically set at 0.05 foot vertical and to applicable horizontal survey standards.

(b) Quality Level “B” (QL-B): Designating

This information is obtained through the application of appropriate surface geophysical methods to identify the existence and approximate horizontal position of subsurface utilities. Quality Level B data are reproducible by surface geophysics at any point of their depiction. This information is surveyed to applicable tolerances and reduced onto plan documents.

(c) Quality Level “C” (QL-C): Surface Visible Feature Survey

Information is obtained by surveying and plotting visible aboveground utility features and by using professional judgment in correlating this information to Quality Level D information.

(d) Quality Level “D” (QL-D): Existing Records

Information is derived solely from existing records or verbal recollections.

(2) Selecting SUE Quality Level

Determining the appropriate quality level for planned construction activities is an important responsibility. If a lower level is specified than what is required for a given construction activity, the project team must be willing to accept the risk for the activity. These risks include the possibility of additional costs due to project delays, bid contingencies, change orders, unnecessary utility relocations, redesign, and perhaps utility damage, as well as other problems. In the past most projects have proceeded at Quality Level C whether or not project teams realized it. However, engineers should be encouraged to determine higher levels knowing that WSDOT may incur liability for lower quality level depictions. Fewer change orders and delays might be realized by using these higher quality levels.

When a highway project includes the types of work described in [Figure 600-3](#), at a minimum, the designated level of SUE needs to be completed.

When deciding the appropriate level of utility investigation, the project team should evaluate the additional costs of a higher quality level versus the potential costs associated with the risk of performing a lower quality level utility investigation. Project teams will identify and apply appropriate techniques based on budgets and expectations. Decisions and judgments must also be made as to where Quality Level A data should be provided. Finished plans may contain utility data with different quality attributes; all four quality levels may be represented in one project.

Type of Work	Quality Level Required			
	D	C	B	A
HMA Overlay Only	X	?		
Guardrail Installation		X	?	
Pipe/Drainage Structures			X	?
Ditch/Pond Excavation			X	?
Roadway Excavation/Widening			X	?
Clearing and Grubbing Operations	X	?		
Removal of Structures and Obstructions	X	?		
Surfacing	X	?		
HMA or PCCP	X	?		
Advanced Geotechnical Work			X	?
Bridge Structures			X	?
Retaining Walls			X	?
Piling			X	?
Signal Systems			X	?
Illumination Systems			X	?
Signing		X		
ITS Systems			X	?
Railroad Crossings			X	?
Roadside Planting		X	?	
Fencing		X	?	
Striping	X			
Mailboxes		X		
Sidewalks	X	?		
Guideposts	X	?		
Monuments	X	?		
Irrigation Systems		X	?	
Curbing	X			
Temporary Erosion Control		X	?	
Sanitary Sewers			X	?
Water Mains			X	?
Concrete Barrier	X			
Pit Site Production	X	?		
X – Minimum level required				
? – Depending on what is found, may need to complete further study to identify conflict areas				

Project Work Type SUE Levels

Figure 600-3

If utilities are expected to significantly impact the project, the Project Engineer should consider utilizing a WSDOT-approved SUE provider. SUE services should be implemented in a two-step process, with QL-B performed early during preliminary design and QL-A performed after identification of potential conflicts.

(a) **Recommended SUE Levels by Project Phase**

1. **Project Planning: Quality Level “D”**

- Review the proposed highway project with the highway planners.
- Determine the type of work to be performed.
- Determine the risks of utility impacts for the work.
- Obtain existing records from utility owners. If utilities are expected to have a significant involvement on the project, the SUE provider can supply record information during the planning phase as part of the QL-B investigation (to avoid redundancy).
- Plot utility information on plan sheets using utility records (QL-D information) and visual indications (QL-C information).
- Review the potential impacts of the utility information for the proposed work.
- If there is a potential for critical impacts, provide contingency funding to address the risk.

2. **Preliminary Design: Quality Level “C” or “B”**

- Review established project limits with the project team.
- Review the type of work to be performed.
- Determine the risks of utility impacts for the work.

If utilities are expected to have minimal impact on the project, proceed with QL-C.

- Survey visible appurtenances (such as hydrants or valves) and match to utility records and topographic features.

If utilities are expected to have a significant impact on the project, proceed with QL-B.

- Apply applicable surface geophysical techniques to determine the existence and approximate horizontal position of underground utilities within the project limits (QL-B information) (*SUE provider*).
- Survey QL-B information to horizontal project survey control and transfer onto the preliminary plans (*SUE provider*).
- Correlate existing utility records with the QL-B information and resolve any discrepancies (*SUE provider*).
- Review the potential impact of the utility information with the proposed work (*designer*).

- At this point, decisions can be made on where to place storm drainage systems, footers, foundations, and other design features in order to avoid conflicts with existing utilities. Slight adjustments in the design can eliminate many utility relocations and enhance safety by moving excavation work away from utilities (*designer*).
- If critical risk is determined for work items (*designer*), then QL-A information should be obtained for those work items (*SUE provider*).

3. Final Design: Quality Level “A”

- Designer shall identify and list potential utility conflicts on the “Utility Conflict Matrix.” QL-A test holes are recommended if a utility conflict may exist within 5 feet—either vertically or horizontally—of a proposed feature (see [Figure 600-4](#)). A blank form is attached for project use.
- Project teams review the Utility Conflict Matrix to approve or reject recommended locations for test holes at certain critical points where the highway design and underground utilities appear to conflict or where additional utility information is desired (*designer*).
- Use nondestructive excavating equipment (such as vacuum excavation) at critical points along a subsurface utility’s path to determine the precise horizontal and vertical position of buried utilities (QL-A information). This involves physically uncovering the utility using a small hole measuring about 8 inches x 8 inches at the top, thus allowing the utility to be accurately surveyed (top to bottom), providing information on its type, size, material, and condition (*SUE provider*).
- Survey QL-A information shall be delivered to the project team and transferred into WSDOT’s CADD system or onto its final plans (*SUE provider*).
- Resolve discrepancies with any previous information shown on the plans (*SUE provider*).
- The project team will then know where the critical utilities are located in three dimensions and can make small adjustments in design elevations, horizontal locations, or structure types and avoid the need to relocate utilities or excavate near them (*designer*).

4. Construction

The Project Engineer should:

- Provide and review all information with bidders at the prebid meeting.
- Provide QL-A and QL-B information to utility owners for their use in relocating utilities.
- Provide QL-A and QL-B information to utility owners and/or one-call centers (811) for their use in marking facilities prior to excavation. SUE data are gathered for design purposes. Utility owners and/or one-call centers retain liability for markings for construction.

Utility Conflict Matrix				
Suggested Quality Level "A" Test Holes				
Project Name: EXAMPLE				
Date:				
Location	Station	Offset	Conflicting Highway Feature	Comments
TH-1	34+24	22' RT	T-duct @ prop bridge abut	
TH-2	34+28	42' RT	T-line btwn prop W & prop S	
TH-3	34+55	42' RT	FO (Qwest) btwn prop W & prop San	
TH-4	34+74	42' RT	FO (AT&T) btwn prop W & prop San	
TH-5	35+10	42' RT	FO (AT&T) btwn prop W & prop San	
TH-6	35+39	18' RT	T-duct @ prop bridge abut	
TH-7	35+40	42' RT	RR signal line btwn prop W & prop San	
TH-8	36+27	17' RT	@ prop abut (UGT)	
TH-9	36+30	20' RT	@ prop abut (UGT)	
TH-10	36+72	47' LT	gas @ prop water	
TH-11	37+98	41' RT	T-duct @ prop water	
TH-12	38+17	15' RT	T-duct @ prop bridge abut	
TH-13	38+37	48' LT	T-duct @ prop W/L	
TH-14	38+78	16' RT	T-duct @ prop abut	
TH-15	39+98	15' RT	T-duct @ btwn W/L & abut	
TH-16	40+52	55' LT	(FO) @ prop W/L	
TH-17	40+62	57' LT	(FO) @ prop W/L	
TH-18	41+35	74' LT	RR comm @ prop W/L	
TH-19	41+70	82' LT	T @ prop W/L	
TH-20	41+51	18' RT	UGT (FO) @ abut	
TH-21	41+55	20' RT	T-duct @ abut	
TH-22	41+73	32' RT	(FO) @ prop bridge abut	
TH-23	44+20	15' RT	T-duct @ prop bridge abut	
TH-24	44+62	40' LT	T-duct @ prop W/L	
TH-25	44+20	26' RT	(FO) @ abut	
TH-26	44+63	71' LT	(FO) @ ret wall	
TH-27	44+65	75' LT	(FO) @ ret wall	
TH-28	44+64	40' LT	T-duct @ prop W/L - - - -	If necessary; see TH24
TH-29	44+65	40' LT	T-duct @ prop W/L - - - -	If necessary; see TH24
TH-30	50+60	20' LT	T-duct with cut	

Sample Utility Conflict Matrix
Figure 600-4

(3) Project Criteria for SUE Application

Although Subsurface Utility Engineering is a useful tool for identifying underground utilities during project design, not all projects require the use of a SUE consultant.

A ground-disturbing project (such as excavating, trenching, boring, driving, or tunneling) that has the potential for conflicts with recorded or suspected underground utility installations would be a good candidate for which to consider hiring a SUE consultant, provided that one of the following applies:

- The project is located within an urban or suburban level of development adjacent to the highway.
- Knowledge of relatively accurate underground utility positions is critical to project design.
- Utility records and as-built information are not known to be 100% accurate and complete.
- Multiple utility owners within the project limits preclude a coordinated, timely, or complete underground investigation by individual utility owners.
- Project construction will extend beyond the current right of way line.
- The project can be designed to avoid underground utility conflicts if the exact utility positions are known.
- The project is a “City street as part of a state highway.”
- Project construction will likely result in utility congestion within an existing right of way and no additional property will be taken.

[RCW 47.24](#)

If your project meets any of the above criteria, contact your Region Utilities Office to obtain the services of a Subsurface Utility Engineering consultant. SUE consultants may also assist with undocumented storm sewer systems encountered on projects.

(4) Utility Relocation Coordination Responsibility

Utility relocation coordination is WSDOT’s responsibility by virtue of the permit or franchise entered into with the utility. Because of existing state law, the department cannot make a contractor responsible for utility relocations by contract provision.

[RCW 4.24.360](#)

When utility relocation is necessary to accommodate a highway improvement or other highway work, there are two utility relocation management alternatives available to project managers.

(a) Utility Relocation Coordination: Department Responsibility

Under this alternative, WSDOT maintains legal utility relocation responsibility. Department project managers are responsible for facilitating and coordinating existing utility relocations between WSDOT’s contractor and utility owners. This alternative places liability for project delay claims resulting from utilities on the department. WSDOT must then pass on any delay costs to the utility that caused the delay.

(b) Utility Relocation Coordination: Assignment to Contractor

This alternative involves the legal transfer of assignment of existing utility permit and franchise rights to WSDOT's contractor. Utility relocation liability and resultant delay claims then become the responsibility of the department's contractor. By the assignment of utility permit or franchise rights to WSDOT's contractor, the contractor has the legal authority to require a utility to relocate and to file delay claims directly against a utility.

Issues such as project size and complexity, existing utility density, the number of individual utilities that require coordination, and other issues should be taken into account when considering utility relocation responsibilities.

(5) SUE Agreement Task Order Process

This section provides direction on the financial ranges to be considered and how they are applied when selecting an on-call consultant for Task orders:

- Task Orders with a cost estimate in the \$0 - \$10,000 range, the Region can pick a consultant from the on-call list. The region then makes a request to the headquarters SUE Agreement Manager to set up a task order for the work.
- Task Orders with a cost estimate in the \$10,000 to \$20,000 range, the Region must solicit a minimum of three (3) consultants from the on-call list, do phone interviews, at a minimum, and the region can make a choice based on the interview process. The Region will notify the consultants of the choice and makes a request to the headquarters SUE Agreement Manager to set up a task order for the work.
- Task Orders with a cost estimate in excess of \$20,000 require a Second tier selection review process. The Region solicits all agreement holders from the on-call list to submit a Request for Additional Information (RFAI). After the proposal is submitted it undergoes an independent evaluation by 3 evaluators. The results of the evaluations are sent to the Project or Agreement Manager to review and the successful consultant best suited for the project is awarded the work. Region contacts the headquarters SUE Agreement Manager to set up a task order for the project.

During the life of the project, and the Master Agreement, amendments for cost increases (which do not exceed funds available for the Master Agreement) or time extensions can be executed by contacting the headquarters SUE Agreement Manager and requesting a Task Order Amendment.

At the end of the project the Task Order dollars needs to be reduced to actual cost by processing an amendment to the Task. In addition, the Project office fills out the consultant performance evaluation, EF 272-019 Performance Evaluation - Consultant Services, and sends it to consultant services and the headquarters SUE Agreement Manager.

600.11 Preliminary Engineering Agreements

Utilities that have a property right and require relocation should be identified as soon as possible in the design process. Preliminary Engineering Agreements can be started between WSDOT and the utility at any time. These agreements define the circumstances and payment for preliminary engineering of relocated utilities. (See [Chapter 2, Utility Agreements](#), for detailed guidance.)

600.12 General Plans Review (60%)

At this stage in the project development process, utility conflicts and relocation details should be well defined, understood, and agreed to by all parties. Detailed SUE investigations should be complete. Utility relocation engineering design should begin (if not already started) for all impacted utilities. Environmental permitting and documentation should be nearing the approval process with the appropriate lead agency.

Detailed utility coordination should now be undertaken. The Region Utilities Office should coordinate highway construction relocation preplanning, identify construction-dependent utility relocations, and negotiate appropriate coordination and installation measures between WSDOT and the utility.

Begin developing and negotiating utility agreements with utility owners that define relocation responsibilities, payments, costs, and other necessary issues.

(1) Utility Relocation Meeting

The Utility Relocation meeting should identify specific utility conflict relocation needs relating to the project. The goal of the meeting should be development of a Utility Relocation Plan, a related schedule, utility relocation responsibilities, and other deliverables and responsibilities between WSDOT and the utility owner.

The Utility Relocation meeting agenda should include some or all of the following items, depending on the needs and circumstances of the project:

- General discussion of WSDOT's utility relocation requirements.
- The addition of any necessary utility relocations to the WSDOT project contract.
- Joint trench and joint pole occupation and responsibilities, both in the utility's current locations and relocated positions.
- Environmental permitting responsibilities.
- A request for utility easement documents or other property rights documents.

General expectations and meeting responsibilities for specific attendees will vary between projects. The following are general meeting deliverables:

(a) Utility Owner

Each impacted utility owner should provide a general description of its utility impacts and provide alternatives for relocation. The utility owner should also provide a written scope of utility relocation work necessary for consideration by WSDOT prior to the department's submittal of the project environmental documentation and permit applications to permitting agencies.

Utility owners will determine whether the information provided in the General Plans Review is sufficient to begin a relocation design. Within a short period after the Utility Relocation meeting, the utility owner should notify the Project Engineer's Office if additional information is required. The Project Engineer's Office should provide a projected schedule indicating when additional information will be delivered to the utility once the utility owner makes the request.

(b) Region Utilities Office

The Region Utilities Office should invite utility owners to the Utility Relocation meeting. Within a reasonable period prior to the meeting, WSDOT should provide utility owners with a General Plans Review identifying existing utility facilities and how those facilities are affected by the highway project. The General Plans Review will include information necessary to enable utility owners to design and plan the layout for the removal and relocation of existing utility facilities as well as the placement of relocated or additional facilities within the project limits.

At the meeting, WSDOT may be able to identify timelines for project right of way negotiations and the completion of the project PS&E. Participants will discuss the impact of the proposed timelines on the relocation of utilities affected by the General Plans Review.

(2) Utility Relocation Planning

After the Utility Relocation meeting, WSDOT should work closely with utility owners to develop a Utility Relocation Plan and schedule. Discussion should include possible cost-effective project design changes that might decrease the amount of or eliminate the need for utility relocation and disruption to utility customers' services.

To ensure the relocation of a utility to a location that avoids proposed highway improvements, other coordination considerations may include:

- Relocation ahead of highway construction.
- Facilitation of joint trench and joint pole occupancy relocation coordination issues.
- Relocation dependent upon some highway improvement and coordination of utility relocation with the highway construction element.
- Coordination between WSDOT's contractor with the utility's contractor to ensure smooth relocation that does not impact the highway project's schedule.
- Relocation work as an element of the highway project, therefore becoming the responsibility of WSDOT's contractor and a project bid item.

 Best Practice

 Best Practice

In addition to coordination and scheduling issues, utility relocations must also meet WSDOT's accommodation policies. Some accommodation requirements that must be addressed include:

- Control Zone Guidelines compliance for surface and aerial utility installations.
- Scenic Classification.
- Subsurface utility installation depths with cross sections.
- Trench backfill.
- Future service connection issues.
- Bridge and structure connections.
- Future maintenance access within full access control rights of way.
- Abandoned utility documentation.
- As-built documentation for accommodation records.

Refer to [Chapter 1, Utility Accommodation](#), for detailed utility installation requirements and guidance.

(a) Utility Relocation vs. Design Changes

During Utility Relocation Planning, WSDOT and utility owners may mutually agree to design changes to accommodate or avoid utility relocations. The Project Engineer's Office should revise the General Plans Review accordingly.

Compensation from the utility for such redesign may be appropriate, depending on the compensable rights of the utility and the circumstances of the redesign.

If compensation from the utility is appropriate, the utility owner will compensate WSDOT for the preliminary engineering costs necessary to revise the design to accommodate the utility owner's desired relocation option.

(b) Preliminary Engineering Agreements

If not already done, the Region Utilities Office and the Project Engineer's Office should work with utilities to develop and execute Utility Preliminary Engineering Agreements with the utility owners.

(c) Service Agreements

Working with information provided by the Project Engineer's Office and at its request, the Region Utilities Office should submit requests for utility service connections to the utility owners.

(3) Utility Relocation Plan Development

The Project Engineer's Office and the utility owners should negotiate the schedule for completion of the Utility Relocation Plan; however, plan development should start as soon as possible. Depending on the circumstances of the project, Utility Relocation Plan development can start anytime in the design process. If possible, start the plan development before the Utility Relocation Planning meeting.

Each utility owner should develop a Utility Relocation Plan for the project based on its own information and information supplied by WSDOT. The plan must include the completed Utility Object Relocation Record (UORR) for surface and aerial utilities and applications for utility permits and/or utility franchises for utilities that have no easement or other property right.

Every Utility Relocation Plan should identify the highway project construction elements that must be completed before utility relocation can begin. The Utility Relocation Plan should also provide a construction window sufficient to allow time for utility relocation construction.

If revisions or changes occur to the project after the Utility Relocation Planning meeting that affect a Utility Relocation Plan, WSDOT should promptly notify any affected utility owners. The Region Utilities Office and the Project Engineer's Office should work with affected utilities to modify Utility Relocation Plans as necessary to adjust to the changes to the project.

The utility owner should track only the increase (if any) in utility relocation design costs attributable to WSDOT's changes to the project, which are provided to the utility owner at the completion of the Utility Relocation Planning endeavor.

WSDOT may reimburse the utility owner, if requested, for appropriate increases in utility relocation design costs directly attributable to design changes made after the Utility Relocation Planning endeavor. Revisions to the project that are caused by factors outside the control of the department, such as "forces of nature," entities outside WSDOT's control, or other causes beyond the department's control, should not be considered for reimbursement.

(4) Utility Relocation Plan Submittal and Approval

Once a utility has completed its Utility Relocation Plan, the Project Engineer's Office, Construction Office, and Region Utility Office will review and approve the plan. Submittals should include UORRs and a completed Utility Accommodation Application (see [Appendix B](#)) if the utility has no easement or other property right. Check the Utility Relocation Plan to ensure it is compatible with WSDOT's Utilities Accommodation Policy, meets previously-agreed-to terms, and is at locations previously agreed to by the utility and the department. Constructibility issues should be discussed and incorporated into the project schedule.

Other WSDOT engineering disciplines may also need to be involved in the Utility Relocation Plan review, including the following:

- Traffic
- Maintenance
- Right of Way (for impacts to monumentation and surveying reference points)
- Region engineering managers
- Hydraulics
- Environmental
- Bridge and Structures
- Materials Lab
- Geotechnical

The Region Utilities Office will coordinate the review of the Utility Relocation Plan, request that the utility owner provide additional information, and revise the plan as necessary to obtain WSDOT approval. The Region Utilities Office should notify the utility of plan approval. Following confirmation that the utility owner has obtained all permits and environmental approvals, utility permits or franchises will be issued to the utility owner and relocation work may begin.

Insert Utility Relocation Plan requirements, specifications, Special Provisions, and plans into WSDOT's construction contract as necessary if utility relocation is to be included in the department's construction contract.

(5) Utility Agreement Preparation and Execution

The Region Utilities Office, in conjunction with the Project Engineer's Office and any necessary specialty groups, should prepare and execute Utility Relocation Construction Agreements with the utility owners once utilities have completed their Utility Relocation Plans and those plans have been reviewed and approved by WSDOT.

600.13 Preliminary Contract Review (90%)

At or near the 90% plan completion stage of project design, all necessary utility relocation issues should be identified, and relocation details such as Relocation Plan Approval, environmental permitting and documentation approvals, and other details should be nearing completion. A final Construction Planning meeting should be held with utilities to confirm utility relocation circumstances and schedules. Preconstruction highway contract relocations should be starting or nearing start-up.

(1) Construction Planning Milestone

The Project Engineer's Office and the Region Utilities Office should review the construction schedule in relation to expected utility relocation work by the utility owner or its contractor to ensure any relocation work will not negatively affect highway project delivery. The Project Engineer's Office should provide utility owners with the project construction schedule and current project information for utility relocation construction.

(2) Letter of Understanding

The Region Utilities Office should prepare a Letter of Understanding (LOU) describing the scope and schedule for the minor adjustment of existing utilities (such as valve boxes or manhole covers) and transmit the letter to the utility owner. The utility owner should sign and return the letter agreeing to the construction schedule. Refer to [Chapter 2, Utility Agreements](#), for detailed information on Letters of Understanding.

(3) Utility Agreement Execution

Utility agreements should already be executed or at least nearing execution. Delay of execution of any utility agreements may delay the processing of utility payments and should therefore be a priority. All efforts should be made to conclude and execute utility agreements prior to Award in order to get the payment information into the Contract Administration and Payment System (CAPS).

(4) Utility Relocation

Utilities with approved Utility Relocation Plans may be relocating utility facilities to approved locations, while other utility relocations may be pending. Give unresolved relocation issues immediate attention at this point in the project. Schedule additional meetings with utility owners and use any available resources to resolve latent issues to avoid last-minute delays to project delivery.

(5) Project Ad and Award Risk Level Assessment

Evaluate and classify each project regarding utility relocations and the level of risk of those relocations to the successful delivery of the project. Risk levels are divided into the following three classifications:

Risk Level 1: Utility relocations are complete.

Risk Level 2: Utility relocations are ongoing but will be completed by the bid opening.

Risk Level 3: Utility work will be concurrent with construction or is dependent upon a construction element in order to occur.

Ideally, every project would go to Ad at Risk Level 1. For those at Risk Level 2 or 3, exception reporting needs to be presented.

600.14 Preadvertisement

Any relocation issues should be resolved at this stage of project development. Existing utilities that can be relocated ahead of construction should already be moved or in the process of relocation.

All utility agreements and Letters of Understanding relating to utility relocation-dependent highway improvements should be executed and entered into WSDOT's accounting system.

Once WSDOT's project is on Ad, a Prebid Opening meeting may be held (if necessary) with prospective bidders to discuss Utility Relocation Plans and scheduled utility relocation windows.

600.15 Design/Construction Utility Relocation Facilitation

Regions where design and construction responsibilities are not shared by the same Project Engineer's Office may benefit from relocation facilitation assistance from the Region Utilities Office. In these situations, detailed project information, relationships, and knowledge can often be lost when a project is transferred from the Project Development Office to the Construction Office. This is especially critical with projects in urban areas where there may be significant utility relocation issues or where there is significant subsurface utility congestion that has potential for impacting a project. Traditionally, early and continuing coordination between the Design Office and the Construction Office goes a long way toward making a smooth transition of information and relocation of utilities.

600.16 Project Award and Construction

Following the Award of the highway contract, WSDOT's contractor must provide the department with a project schedule. Among other scheduling responsibilities, by specification in the project Special Provisions, WSDOT's contractor is required to:

- Provide the Project Engineer's Office and the affected utility owner with a notice specifying the number of working days before project work is expected to be completed, so the utility owner may begin its relocation work.
- Issue a notice through the Project Engineer's Office to proceed with utility construction work, giving a specified number of working days before the utility work is to commence.
- Notify the Project Engineer's Office and the affected utility owner at least 24 hours prior to the utility relocation construction start date identified in the Notice to Proceed if circumstances arise that prevent the WSDOT contractor from completing the work by the date specified in the Notice to Proceed.

The Project Engineer's Office is responsible for ensuring the inclusion of utility relocation construction windows within the WSDOT project contractor's construction schedule.

(1) *Preconstruction Meeting*

Prior to commencement of construction operations, the Project Engineer's Office holds a Preconstruction meeting. The Project Engineer's Office should request utility owners and SUE consultants' attendance at the meeting. Utility owners should be encouraged to attend the meeting and any other project meetings where issues affecting utility owners might be discussed.

For those elements of the Utility Relocation Plan dependent upon WSDOT's contractor's work, the Project Engineer's Office, department contractor, and utility owner will develop a utility relocation schedule, consistent with the Letter of Understanding and contract provisions, that includes the utility relocation work windows, notices to proceed, and work notification requirements.

After the Preconstruction meeting, the Project Engineer's Office should send copies of meeting minutes to utility owners.

The utility owner should promptly proceed with the utility relocation work as described in the Utility Relocation Plan.

In the event of unforeseen conditions requiring changes to either the project scope of work or the schedule of work, the Project Engineer's Office and the utility owners should make every effort to coordinate said changes in a manner that minimizes impacts to the project's contractor.

Excusable delays encountered by WSDOT or the utility owner related to utility relocation work to be performed by the utility owner or its agent should be documented in writing by the party encountering the delay. Documentation should then be sent to either the Project Engineer's Office or the utility owner, as appropriate, within five days of the start of the delay.

600.17 Developer Projects and Utility Relocation

In the past, differences in law and policy have created misunderstandings and delays in coordinating utility relocations when a developer is required to improve the roadway facility as mitigation for the developer project. WSDOT, representative utilities, and developers have created a guideline to handle these relocations and the responsibility for the expenses incurred. For further information, refer to WSDOT's [*Development Services Manual*](#).

700.01	General
700.02	Jurisdiction and Authority
700.03	Traffic Control and Safety
700.04	Buried Facilities
700.05	Aboveground Facilities
700.06	Bridge Attachments
700.07	Environmental Requirements
700.08	Communication With Others
700.09	Documentation

700.01 General

Use this chapter as a guide for the inspection of utility work within the Washington State Department of Transportation (WSDOT) operating highway right of way. Utility work may consist of installing new facilities or adjusting, modifying, removing, or relocating existing utility facilities. Utility work may be necessary because of a state highway project or at the request of the utility as part of a franchise or permit.

The most common scenarios that may occur during the inspection of utility work are discussed in this chapter. Additional investigation may be necessary regarding various requirements, resources, and guidelines for specific issues that may arise during inspection, including the following:

- WSDOT *Utilities Accommodation Policy*
- Specific contract plans
- Washington Administrative Code (WAC) 468-34-250
- Current *Standard Specifications for Road, Bridge, and Municipal Construction (Standard Specifications)*, M 41-10
- *Standard Plans for Road, Bridge, and Municipal Construction (Standard Plans)*, M 21-01
- *Work Zone Traffic Control Guidelines*, M 54-44
- *Manual on Uniform Traffic Control Devices (MUTCD)*
- Other resources as required

Utility inspections are conducted to:

- Ensure utility worker safety.
- Ensure the safety of the traveling public.
- Protect transportation infrastructure such as roadways, structures, or other facilities.
- Avoid conflicts with maintenance and highway construction activities.
- Ensure utilities are installed as approved by the appropriate authority.

Utility inspectors are an important part of the Region Utilities Office and should be involved in all phases of the utility accommodation approval process. Their role often begins in the initial review phase of a utility application by assisting Utilities Office staff with the review of a proposed utility installation. Inspectors should remain involved through application approval, taking charge of the oversight of utility construction when installation begins. Once construction is complete, inspectors are to ensure proper highway and roadside restoration.

Among other duties, one of the primary responsibilities of utility inspectors is to ensure utilities are installed at the preapproved location and at the depth/height shown on the document authorizing the installation. However, inspectors are not approval authorities. Inspectors should discuss changes to preapproved utility installations with the delegated approval authority before allowing any deviations from preapproved plans, specifications, and exhibits of the permit or franchise or the Utility Relocation Plan. The inspector is to be given copies of the appropriate documents/plans in a timely manner to ensure adequate time for review prior to the start of construction.

Note that the term “utility” as used in this chapter refers to any organization performing utility work, such as a utility company, local agency, or third party contractor. Where the *Standard Specifications* uses the term “Contractor,” inspectors should interpret that to mean “utility.”

700.02 Jurisdiction and Authority

WSDOT has a responsibility to ensure utilities are installed in the manner approved and to ensure construction activities minimize or eliminate damage to highway infrastructure within the operating highway right of way. The department must also ensure utilities and their contractors are undertaking such work in the safest manner possible. [RCW 47.44](#) and [WAC 468-34-100](#) provide WSDOT authority to take reasonable and appropriate action to ensure these requirements and responsibilities are met.

(1) General Highway Right of Way Oversight

As a WSDOT employee, it is the utility inspector’s responsibility to look out for the best interests of the department. Similar to highway maintenance forces, utility inspectors may travel many miles of highway each day. While traveling, inspectors should be alert to any right of way encroachments, breaks in access, or other activities that may be occurring within the right of way, regardless of whether or not they are utility-related. If the activity appears to be utility-related, the utility is required to have a copy of an approved utility permit or franchise and environmental documentation on-site. Inspectors have a responsibility to stop and ask the responsible person to provide a copy of the approved permit or franchise document that authorizes them to perform work within the right of way. Approved traffic control must be in place for any operation within the right of way. If the activity is not utility-related, the inspector should contact the appropriate Area Maintenance or Construction Office to ensure the work is authorized.

(2) Utilities Under Permit or Franchise

Where a utility is performing work as part of a utility permit or franchise, the utility is required to follow the provisions contained in the permit or franchise. An executed permit or franchise, signed by the utility and WSDOT, is a legal and binding agreement. General Provision #1 of the [Utility Accommodation Application](#) (see [Appendix B](#)) states:

This document is subject to RCW 47.32, RCW 47.44, and WAC 468-34, and amendments thereto.

These state laws give WSDOT authority over, and provide requirements for, utility work within state right of way. General Provisions and Special Provisions provide additional requirements.

Utility installations authorized by permit or franchise have no compensable real property interest. Reimbursement to WSDOT is required for reasonable costs incurred by the department for work associated with the inspection of utility installations.

(3) Utilities With Compensable Real Property Interest

Unlike utility installations authorized by permit or franchise, WSDOT does not possess the same jurisdiction and authority when a utility owner possesses a compensable real property interest. This condition generally occurs when relocation of a utility is necessary to accommodate a highway improvement project. The utility is either located within the operating highway right of way by easement or the department must acquire additional right of way for a highway improvement. The utility either owns the adjacent property fee title or has an easement on the adjacent property. In either case, the utility has a compensable real property interest.

When a utility has a compensable real property interest or a property right, the relocation of existing utility facilities that are in conflict with a highway improvement project is generally done at WSDOT's expense. In this situation, the department enters into a utility agreement with the utility owner for the relocation of the existing utility facility. The utility agreement specifies the terms of the relocation, such as payment for the work and responsibility for the actual relocation work and other details such as inspection and acceptance by WSDOT. Any improvements beyond the necessary relocation are at the expense of the utility owner.

In all cases, the agreement should state that the utility installation must comply with applicable requirements of WSDOT's [Utilities Accommodation Policy](#) and associated WACs and RCWs. Refer to [Chapter 1](#), Utility Accommodation, for additional information on utility accommodation requirements, and [Chapter 2](#), Utility Agreements, for detailed information on utility property rights.

Any utility within the operating highway right of way, whether authorized by permit or franchise, or by virtue of a property right, must obtain preapproval from WSDOT before accessing the operating highway right of way to work on utility facilities.

(4) Utilities on State Highways Within Incorporated Cities/Towns

[RCW 47.24.020](#) defines the jurisdiction and control of city streets where they are part of a state highway.

Where a city street is part of a limited access controlled highway, title to and control over the highway are vested in the state. Therefore, full jurisdiction, responsibility, and control over such facilities are exercised by WSDOT. However, cities also have the right to require that utilities be installed underground. City requirements that exceed those of the department are negotiated between the utility and the local agency. WSDOT cannot be held responsible for any additional costs of undergrounding or other actions that may be required by local agency ordinances.

Where a city street is part of a nonlimited access controlled highway, the city or town exercises full responsibility for and control over any such street beyond that portion used for highway purposes (for example, beyond the curbs). The city has the right to construct and maintain underground utilities within the roadway, as well as grant permits and/or franchises for other organizations to construct and maintain utilities within the roadway, including open cuts of the pavement. However, WSDOT reserves the right to ensure restoration of the roadway meets or exceeds department requirements. Regions should work to insert themselves into local agencies' approval processes when open cuts are proposed for utility installations on state highways within city limits. The inspector is to research the city's open cut policies to be able to enforce the local requirements.

700.03 Traffic Control and Safety

The safety of workers and the traveling public is a primary concern of utility inspectors. To ensure safety issues have been addressed appropriately, utilities are not authorized or allowed access to the operating highway right of way without first obtaining written approval from WSDOT.

(1) Traffic Control Plans

The utility or its contractor must have a copy of a WSDOT-approved Traffic Control Plan (TCP) on-site for each setup it is using and, if required, have a Traffic Control Supervisor (TCS) present. The TCP must fit the on-site conditions for the work taking place.

When issuing a utility permit or franchise, a utilities accommodation best management practice (BMP) is to include a WSDOT-approved TCP, which may consist of:

- A TCP drawing taken from the [Work Zone Traffic Control Guidelines](#).
- A TCP drawing taken from a Region Traffic Office CADD library.
- A TCP submitted by the utility and approved by the Region Traffic Engineer or delegated personnel.

The Region Traffic Engineer or delegated personnel determines whether the utility will be required to have a TCS on-site and notes it on the approved TCP.

Site-specific conditions may require modification of the Traffic Control Plans included in the permit or franchise or possibly the development of a new TCP. In either case the new or modified TCPs must be submitted to the Region Utilities Office for review and approval by the Region Traffic Engineer or delegated personnel prior to use. To accommodate site conditions, minor revisions to approved TCPs may be made by a certified TCS, with the inspector's approval and provided the inspector is also a certified TCS.

To minimize delays, utilities should be encouraged to submit standardized Traffic Control Plans contained within the *Work Zone Traffic Control Guidelines* or Region Traffic Office libraries. When appropriate for conditions, seeking approval for use of standardized plans can save time in the TCP approval process. Many standardized Traffic Control Plans may contain minor items that will need to be changed to fit field conditions.

(2) Construction Equipment and Materials

Construction equipment and materials that can create hazards to the traveling public are to be staged outside the clear zone. Positive protection, such as concrete barrier with proper taper rates and end treatments, should be considered when staging is necessary within the clear zone and where errant vehicles have a potential for impact with equipment or other materials.

During working hours, only the materials and equipment being used may be within the clear zone. All nonessential equipment, materials, and private vehicles (including flaggers' vehicles and the inspector's vehicle if not being used) are to be located outside the clear zone. This may require an off-site staging area with shuttling of personnel materials and equipment from the staging area to the work site. The staging area is not to limit sight distance on the highway or adjacent roadways/approaches.

During nonworking hours or whenever equipment and materials are not protected by appropriate traffic control devices (concrete barrier or guardrail), they are to be located outside the highway clear zone. The clear zone distance is determined by speed limit, slope, and average daily traffic (ADT) for that section of highway and can be obtained using the Design Clear Zone Distance Table and recovery area formulas located in Chapter 700 of the *Design Manual*. The *Design Manual* provides a minimum distance for determining the clear zone. The inspector is to ensure the proper design clear zone distance was selected and may require that the actual clear zone distance used exceeds that taken from the *Design Manual* if field conditions dictate.

Construction equipment or vehicles that are not intended for street use will not be allowed to operate outside designated work zones without proper traffic control and will require a shadow vehicle if traveling between work sites. Large tracked vehicles are to be transported on trailers to prevent damage to the roadway surface, including crossing of roadways.

700.04 Buried Facilities

Underground utilities are generally installed by one of the following methods:

- **Conventional Trenching:** Use of a backhoe or excavator to remove existing material to the proper line and grade (not allowed on existing paved roadways).
- **Plowing:** Use of a bulldozer equipped with a large, hollow tine to simultaneously cut into the earth and place the utility line.
- **Trenchless Technology:** Use of specialized equipment to jack, auger, or drill a tunnel for the installation of a utility line. This method is preferred for all buried crossings of existing roadways.

All buried utilities are to adhere to the construction requirements in [WAC 468-34-250](#) and the *Standard Specifications*. For detailed guidance on buried utilities, refer to [Chapter 1](#), Utility Accommodation.

(1) Location, Depth, and Materials

The horizontal location and depth of a utility line is critical to ensuring the facility will not affect the structural integrity of the roadway or be in conflict with future maintenance and construction activities. Installation must be at the location and depth shown in the approved permit or franchise document, the Utility Construction Agreement, and/or the Utility Relocation Plan approved by the department for the installation.

When the types of materials used for utility installations are the same or similar to those used on WSDOT contracts, the materials must meet the same requirements described in the *Standard Specifications* and/or the Qualified Products List (QPL). If the materials used for a utility installation are not found in the *Standard Specifications* or the QPL, they must meet industry standards and be approved by WSDOT prior to use. Any specific requirements made by the Region Utilities Office are also to be specified in any preapproved documents.

A review of the utility's plans must be done by the inspector well in advance of installation. This review can help head off potential problems with location/depth, materials approval, construction delays, and/or additional costs to the utility. Inspectors are to consult the Region Utilities Engineer if they are unsure whether a utility line should be installed at a particular location and/or depth or whether a specific type of material should be used.

(2) General Pipe Installation Requirements

The general construction requirements for pipe installations are specified in [Chapter 1](#), Utility Accommodation, [WAC 468-34-250](#), and Section 7-08.3 of the *Standard Specifications*.

(3) Compaction

Acceptance of the utility's work is done primarily by visual inspection. However, if an inspector feels an adequate compactive effort is not being applied by the utility, the inspector may require the utility to provide compaction testing to ensure adequate compaction is being achieved. The utility must either apply a compactive effort to the satisfaction of the inspector or provide test results to indicate adequate

compaction is being obtained. However, the method of compaction is not negotiable. The utility or contractor must meet the requirements of [WAC 468-34-250](#) and the [Standard Specifications](#).

WSDOT may conduct the compactive testing in cases where the utility does not have available resources or is unable to hire a certified tester to perform the testing. Any costs for testing incurred by the department are to be charged directly to the utility.

(4) Roadside Restoration

The utility is to restore all disturbed areas of soil, grass, shrubs, trees, or any combination thereof. Areas are to be restored in accordance with Standard Specification 8-02, the [Design Manual](#), the [Roadside Classification Plan](#), and the [Roadside Manual](#), and may include additional requirements from the Region Environmental Office. The inspector should consult with the Region Landscape Architect, who will work with the Region Environmental Office and the Maintenance Superintendent to determine the best course of action for each site.

700.05 Aboveground Facilities

There are three primary concerns relating to the installation or relocation of aboveground utilities. Generally, the approved location of utilities will be as defined in approved utility permits or franchises or utility relocation plans. Inspectors should be familiar with WSDOT policies regarding these requirements and be prepared to enforce the content of approved accommodation documents to ensure:

- Facilities avoid conflict with existing department facilities, highway construction, and maintenance activities.
- Facilities meet [Work Zone Traffic Control Zone Guidelines](#) (see [Chapter 9](#), Control Zone, for detailed information on control zone issues).
- Overhead utility lines have adequate vertical and horizontal clearance between the roadway and power lines/poles, WSDOT luminaires, guardrail, structures, drainage features, and so on.

The approved accommodation document and approved Traffic Control Plans must be on-site and must be followed, regardless of how quickly the work can be done.

The location of guy wires and anchors should be looked at closely for conflicts with existing utilities, clear zone requirements, future projects, and private landowners.

700.06 Bridge Attachments

Utilities may be installed on a highway structure by utility agreement as part of a WSDOT highway improvement project, or a utility or its contractor may make the installation independent of highway work. Regardless of who is responsible for the work, all attachments to structures must have written approval from the Headquarters (HQ) Bridge and Structures Office prior to installation.

When proposing an attachment to a structure, utility owners must submit plans detailing their attachment methods to the region for processing and approval by the HQ Bridge and Structures Office. Inspectors are to have access to copies of the office's approved plans and details. Refer to [Chapter 1](#), Utility Accommodation, for detailed information on obtaining bridge and structure attachment approvals.

700.07 Environmental Requirements

Generally, utility work within the operating highway right of way must meet the same standards as those imposed upon WSDOT. In some cases, however, utilities are exempt from certain environmental requirements, per [WAC 197-11-800\(23\)](#). Environmental regulations for different types of work vary based on the area of the state in which the utility facility is being installed and the impact(s) the work may have upon natural resources. Inspectors should be aware of what impacts utility work is having on the environment and inform the Region Environmental Office about environmental concerns prior to the start of work. Where there are known violations of environmental regulations, the inspector is to notify the Region Environmental Office and instruct the utility to cease work until the work can proceed in compliance with said regulations.

(1) Permits and Franchises

Where a utility is performing work as part of a permit or franchise, the utility owner is required to obtain all necessary environmental permits prior to beginning work. Where WSDOT has concerns related to the utility's environmental permits, the utility will be required to make those permits available to WSDOT prior to notice to proceed and, if part of the approval of the work, must have the permits on-site during construction (see [120.12](#), Environmental Considerations). The inspector should be given copies of the permits in advance of construction to review and then keep on-site during construction.

(2) WSDOT Projects

Where a utility is performing work related to a WSDOT project, the work may or may not be covered by the department's environmental permits for the project. Prior to the start of any utility work, the inspector should determine whether the utility is covered by WSDOT permits or has obtained its own permits.

Where the utility's work is covered by WSDOT's environmental permits, the inspector and the utility will be provided with copies of the permits, as well as the commitments made by WSDOT to the permitting agencies. Inspectors are to ensure the utility has copies of the permits and commitments on-site and that its work follows those requirements.

(3) Potential Problems and Common Requirements

A utility inspector should always be alert to the following potential problems:

(a) Hazardous Waste and Spill Prevention

Contaminants brought on-site by the utility, as well as contaminated water and soil encountered during excavation are to be contained and/or removed from the job site, and the Region Environmental Office, other appropriate region authority, or the headquarters Hazardous Materials Program, is to be notified. Existing contamination, residual contamination from a cleanup, or portions of a contaminated site, in the right of way may be indicated by a notation on the Right of Way Plan. Therefore the utility inspector must review the Right of Way Plan sheet[s] for potential for contamination to exist in the area of utility work. The notation will include information on the nature of contamination and include specific use restrictions to protect the integrity of the cleanup and limit the risk of exposure of hazardous substances. The utility should have a Spill Kit on-site and, in some cases, a Spill Prevention, Control, and Countermeasures (SPCC).

(b) Erosion and Sediment Control

Whenever it is necessary to remove vegetation or perform excavation, the utility is to take measures to control the erosion of soils and the transportation of sediment. The utility should use best management practices (BMPs) to ensure this is accomplished and may be required to provide a Temporary Erosion and Sediment Control (TESC) Plan (determined on a case-by-case basis). Special care should be taken to ensure water containing unacceptable amounts of sediment does not leave the work area. All water and sediment are to be contained within the work area until properly treated to an acceptable level. No untreated water is to be allowed to leave the work area or enter any waters of the state or private property.

In addition to controlling erosion and preventing sediment from entering any waterway, the utility is also to control airborne erosion particles such as dust.

(c) Dewatering

The utility must not allow discharged water from dewatering to leave the right of way unless it has obtained written permission from the subject landowner and provided a copy to the inspector. The utility should be aware at all times where the discharged water is flowing. Requirements for hazardous waste, erosion, and sediment control apply to dewatering operations, and the inspector is to remain alert to the potential for these types of problems as well as possible damage to the roadway.

(d) Cultural or Archaeological Discoveries

During excavation, the utility should be alert to the possibility of discovering items of cultural or archaeological significance, such as skeletal remains, fossils, or other artifacts. If these types of items are encountered, the utility will cease work immediately and inform the inspector (if not already present). The inspector will contact the Region Environmental Office for further notification of the proper authorities. The utility must obtain written approval from the approval authority before restarting work.

700.08 Communication With Others

Utility inspectors will be communicating with a variety of individuals from many different organizations. They should have contact information for WSDOT Environmental, Hazardous Materials, Maintenance, Electrical, and Traffic offices, as well as utilities, construction PEOs, local governments, the Department of Ecology, emergency services, and others.

(1) Utility Companies

Officials and employees of utility companies will make up the majority of the people with whom the inspector will be communicating. The inspector should maintain good working relationships with these individuals, respecting their opinions and ideas, while still upholding the best interests of the department.

(a) **Utility Forces**

Installation by a utility company's own forces means communicating with representatives of the utility that holds the approved accommodation document. This is a direct relationship between the department and the utility owner, and the utility inspector should feel free to communicate with the crew foreman directly.

(2) Contractors

Installation of utilities may be done by utility company forces or by contractors hired by the utility to install utilities on the company's behalf. For WSDOT utility inspectors, the inspection relationship may differ between the two. Regardless of who is doing the work, the necessary documentation must be on-site. If not, the contractor is to immediately stop work within WSDOT right of way until the approved accommodation document and other required documentation is obtained and available on-site.

(a) **Utility Contractors**

Utility companies often contract with a third-party contractor to install utilities on the utility owner's behalf. This is an indirect relationship between the contractor and WSDOT. Utility owners are ultimately responsible for the conduct of their contractors and are required to have their own inspectors on-site to monitor their contractors' work.

All permits and franchises approved and issued to utilities are to contain a Special Provision with the following language:

Should the utility choose to perform the work outlined herein with other than its own forces, a representative of the utility shall be present at all times unless otherwise agreed to by the department representative. All contact between the department and the utility's contractor shall be through the representative of the utility.

Inspectors usually communicate directly with a utility contractor without any problems. However, the utility inspector may also work with the utility owner's contact responsible for oversight of the contractor. Even though WSDOT has an indirect relationship with the contractor, safety issues are to be immediately communicated to the utility's contractor and the utility.

(b) **WSDOT Contractors**

On WSDOT projects, the official representative of the department is the Project Engineer, who typically delegates authority to project inspectors. The relationship between the utility inspector and the Project Engineer's Office may differ slightly between projects. However, as subject matter experts, utility inspectors should work to insert themselves into the project appropriately to ensure the department's Utilities Accommodation Policy is adhered to in a manner that does not delay the delivery of the project. If appropriate and agreeable to the Project Engineer, utility inspectors may communicate directly with WSDOT's contractor.

(3) Preconstruction Conferences or Meetings

Preconstruction conferences or meetings are an effective way to communicate about upcoming utility work. Where utility work is included in a WSDOT highway construction contract or is taking place during the progress of work on the project, the formal preconstruction conference held by the Project Engineer provides a means of communication between the state, its contractor, and the utilities. This type of meeting allows all parties to discuss how they will coordinate and schedule the various items of work.

Where utility work is taking place prior to or separate from a WSDOT project, a preconstruction conference or meeting will need to be organized between the state and the utility or utilities. This can be accomplished by a formal “sit-down” meeting in an office setting, an on-site meeting in the field, or by telephone (in some cases), depending on the complexity of the work to be performed.

700.09 Documentation

Documentation of utility activities is important for a number of reasons. The Region Utilities Office needs accurate records of the type, size, and location of utilities within the right of way. Although the utility is required to provide this information in its permit or franchise application as well as as-builts, good documentation will help to verify the information the utility provides.

- Documentation of past utility construction can help to determine how future construction activities might be done. This could be quite valuable for making decisions during the accommodation process or while coordinating the relocation of utilities during the design process.
- Documentation of the actual hours worked by an inspector on a specific project could assist in settling disputes over charges received by a utility for inspection.
- Documentation of work activities related to payable utility agreements is essential to verifying that the invoice submitted by the utility contains work that was actually performed and costs that were actually incurred.

Documentation is typically done using the diary page of the Inspector’s Daily Report ([DOT Form 422-004A EF](#)). However, it is not mandatory that this form be used as long as the work is documented in some way, such as by e-mail, MS Word, or Construction Project Diary ([DOT Form 422-014](#)).

Documentation of utility work should contain all pertinent information regarding the work, such as date; times; SR number; milepost; offset from centerline; type, size, and quantity of materials used; traffic control; and work activities. Equipment hours used, labor hours, and occupations may also be valuable information to document. Record all pertinent conversations; orders given; weather; site conditions; problems encountered and their resolutions; times when work activities changed; and times when traffic control changed. Take pictures before, during, and after construction, including traffic control setups. Record any as-built conditions that are a change to the original permit/franchise or agreement. Document the reasons and approvals for the changed conditions. Record offset and distances to any changed installation.

800.01 General

800.02 Utility Accommodation Reimbursement Policy

800.01 General

The Washington State Department of Transportation's (WSDOT's) Utilities Accommodation Policy describes the means by which the department may accommodate utility installations within the state's operating highway right of way. The general intent of the Accommodation Policy is to allow only the installation of utilities that will not interfere with the safe and continued maintenance and operation of state highways.

Conflicts with installed utilities frequently occur as highway infrastructure needs increase and WSDOT undertakes capital improvements to meet additional transportation demands. Dealing with these utility conflicts in the project delivery process often results in the expenditure of limited department resources on issues not directly related to highway improvements. In order to minimize the impact of those additional resource expenditures, WSDOT has created a reimbursement policy that defines how to recover department expenses related to utility accommodation and construction conflict resolution.

800.02 Utility Accommodation Reimbursement Policy

WSDOT will recover costs and expenses related to requests for the accommodation of new utilities within the operating highway right of way (see [110.03\(4\)](#), Reimbursable Accounts). Reimbursement will also be made by utilities for select costs incurred by the department in dealing with existing utilities authorized by permit or franchise that come into conflict with the delivery of WSDOT capital highway improvement programs (also referred to as project delivery).

(1) Utility Accommodation

Collected utility permit and franchise fees will be used to offset costs for mailing; copying; adding information to WSDOT databases; release of individual sureties; costs associated with processing and depositing of application fees; and approval or denial of applications.

WSDOT engineering costs will be recovered from the utility for the approval of applications, including engineering or other reviews by necessary WSDOT personnel and any approved modifications to the application on behalf of an applicant.

Engineering activities that may be necessary to approve the application typically include, but are not be limited to:

- Field review by maintenance and other region disciplines, as necessary.
- Engineering review of the application and supporting documentation, which must include clear zone calculations, scenic classification issues, utility facility descriptions, exhibits, variance justification, or other WSDOT requirements ([WAC 468-34-170](#)).

- Construction oversight and documentation, which may include inspection of the utility installation; travel time to and from the site; monitoring work site traffic control; oversight of installation methods and materials; and verification of as-built information.

The benefits of utility accommodation cost recovery include:

- Utility facility construction is per approved plans.
- Traffic control per the *Manual on Uniform Traffic Control Devices*.
- Alleviation of maintenance problems (proper cleanup and restoration of work zone).
- Accurate and timely as-builts.
- Knowledge of utility installation's completion date.
- More accurate and realistic permit and franchise application submittals.
- Improved coordination of utility accommodation proposals with respect to WSDOT operations and planned capital improvement projects.

(2) Project Delivery

The majority of WSDOT projects are impacted by existing utilities located within operating highway rights of way. The department's design process generally begins by identifying existing features within the highway right of way. This identification may include existing topography, highway design elements, drainage, and right of way boundaries, as well as known existing utilities.

WSDOT-funded preliminary engineering costs during the initial design phase of a project should include:

- Utility coordination.
- Field surveying.
- Initial highway design.
- Requesting, plotting, and evaluating as-built utility information supplied by utilities (Subsurface Utility Engineering [SUE] Quality Level D).¹
- Locating utilities in the field (SUE Quality Level C).
- Performing surface geophysical techniques (SUE Quality Level B) in urban areas where subsurface construction is anticipated.
- Scheduling and holding Project Plan Overview and Utility Relocation meetings.
- Other work (up to the point utility conflicts have been identified).

When relocation or adjustment of existing utilities becomes necessary, WSDOT will recover costs associated with addressing and accommodating those utility relocations.

¹For more information on SUE levels, see [600.10](#), Subsurface Utility Engineering (SUE).

Preliminary engineering cost recovery will include:

- Charges for modifying the original design to avoid utility relocation.
- Determining the precise horizontal and vertical positions of underground utilities (SUE Quality Level A).
- Utility Relocation Plan review and approval.

Construction engineering cost recovery will include:

- Charges for construction inspection.
- Costs associated with utility relocation incorporated in WSDOT's construction contract.

Other charges, such as utility-caused contractor delays, may also be recovered.

The benefits of utility relocation and highway redesign cost recovery include:

- Better plans (submission of poor-quality plans costs utilities more).
- Better responsiveness from the industry.
- Added value to the projects by the Region Utilities Office (identifying conflicts and problems prior to contract award).
- Creation of a higher level of internal and external accountability.
- Decrease in utility-related delay cost overruns and related issues.
- Documentation of reasonable utility relocation notification efforts by WSDOT, providing the ability to pass on any utility-related delay costs to unresponsive utilities.
- Assurance that utility designs and installations on highway projects are in keeping with the Accommodation Policy and associated state and federal laws and directives.

(3) WSDOT Cost-Recovery Requirements

WSDOT will recover expenses actually incurred for both engineering and administrative services.

WSDOT will recover costs from utilities associated with the investigation and processing of application requests for accommodating utility facilities on the operating highway right of way.

WSDOT will recover costs from utility owners for expenses associated with project delivery activities directly attributable to relocation of utilities located in the operating highway right of way, including department charges necessary for:

- Modifying the highway design.
- Relocation Plan approval.
- Construction oversight and inspection.
- Utility-caused contractor delays.

(4) Region Cost-Recovery Requirements

Regions are required to establish a system to track and maintain supporting documentation for any charges billed to utilities resulting from WSDOT's cost reimbursement policy. Regions will review all charges to utilities to ensure charges are appropriate to the application and project delivery processes.

Regions will provide training to applicants (if requested) to ensure minimal delays and expenses for their utility permit or franchise processing.

- 900.01 General
- 900.02 Clear Zone vs. Control Zone
- 900.03 Control Zone Objective
- 900.04 Definitions
- 900.05 Application
- 900.06 Control Zone Distance
- 900.07 Recovery Area
- 900.08 Supplemental Utility Design Information
- 900.09 Project Applications
- 900.10 Completing the Utility Object Relocation Record
- 900.11 Variance
- 900.12 Variance Request for Location I Objects
- 900.13 Variance Request for Location II Objects

900.01 General

Washington State's Strategic Highway Safety Plan (SHSP) establishes strategies to reduce traffic fatalities and serious injuries along state highways, and identifies utility objects, specifically utility poles, as significant roadside hazards. This chapter addresses the objective of eliminating utility object collisions in accordance with the SHSP and provides guidance on the placement of aboveground utilities within Washington State Department of Transportation (WSDOT) highway rights of way. Further information regarding the SHSP can be found at: <http://targetzero.com/pdf/targetzeroplan.pdf>

900.02 Clear Zone vs. Control Zone

Clear Zone is defined in the WSDOT *Design Manual* as “The total roadside border area, available for use by errant vehicles, starting at the edge of the traveled way and oriented from the outside or inside shoulder (in median applications) as applicable...”

From a technical standpoint, Control Zone and Clear Zone are synonymous in that the criteria and methodology used to calculate the two are identical. The distinction is one of policy in applying measures to achieve compliance. The differing policies are based on the recognition that accommodation of utility facilities within the state highway right of way is in the public interest when such use and occupancy do not adversely affect highway operations or safety. Control Zone Policy recognizes that practicable options for utility accommodation are sometimes limited to the right of way under WSDOT's control and allows for certain measures, including variance approvals of utility objects, with due consideration for the safety of highway users.

It is critical for WSDOT staff to work cooperatively with the utilities in implementing these guidelines during both accommodation and project delivery coordination, including helping utilities to understand the methodologies involved with Control Zone calculation and ensuring any necessary corrective action or other remedies specified in this chapter are implemented.

900.03 Control Zone Objective

The primary objective under WSDOT's Control Zone Policy is for all utility objects to be located outside of the Control Zone.

It is not always possible for utilities to achieve this objective for reasons that include physical/topographic limitations and unjustifiably high costs associated with relocating or undergrounding lines. Because of this, Control Zone Policy allows for authorizing variances for individual utility objects when justification can be demonstrated. These processes and criteria are described in [900.11](#).

900.04 Definitions

See [Appendix A](#), Glossary.

900.05 Application

All new utility objects will be constructed outside the Control Zone unless a variance is authorized. In addition, utilities will be required to relocate or mitigate existing objects within the Control Zone by addressing existing objects during WSDOT highway projects, utility reconstruction, and Franchise Renewal/Consolidation, or if the department determines that any existing objects must be relocated or mitigated for the safety of highway users.

(1) Utility Construction or Reconstruction

During utility construction or reconstruction, the utility will locate or relocate all utility objects to outside the Control Zone unless they are classified as Location III Objects or a variance is granted.

(2) Highway Improvement Projects

During the planning phase of state highway improvement projects, WSDOT will inform the utility that it is required to adjust utility objects that, either prior to or as the result of the project, are located in the Control Zone. For WSDOT highway safety projects (such as I2 projects), additional relocation or mitigation for objects outside the Control Zone may be necessary. In these cases, WSDOT will work with the utilities and adjoining property owners to determine available options and coordinate any necessary corrective action.

WSDOT will notify the utilities of upcoming highway improvement projects as early as possible. During the project development phase, the utility will be advised of the scheduled project advertising date and of those utility objects requiring relocation.

(3) Franchise Renewal and Consolidation

Prior to renewal or consolidation of franchises that include aboveground utility objects, the utility shall identify all Location I and Location II Objects within the proposed Franchise Renewal or Consolidation and submit a Corrective Action Plan and schedule of relocation, reclassification, or countermeasures for WSDOT review and approval. It is expected that a utility company will budget resources to accomplish the work necessary to renew franchise documents, including bringing its facilities in compliance with Control Zone requirements.

900.06 Control Zone Distance

The Control Zone distance for any particular highway segment varies according to the posted speed, traffic volumes, and sideslopes of the highway. This section contains methods and supporting information on determining the Control Zone distance for a particular location along the highway, including:

- General guidance for determining Control Zone distance.
- Different methods of Control Zone calculation and examples applicable to various highway geometric conditions (Conditions 1 through 6).
- Clear Zone Distance Table (see [Figure 900-9](#)) to be utilized in Control Zone calculation.
- Recovery Area Formula for use with Conditions 4 and 6.

(1) General Guidance for Determining Control Zone Distance

- All distances are measured from the edge of the through lane, extending outward perpendicular to the traveled way.
- Roadside is the distance measured from the edge of the through lane to the beginning of the backslope, as in Conditions 2, 3, and 4, and from the edge of the through lane to the toe of the slope, as in Condition 6.
- The Shoulder in the diagrams provided is understood to be the “Useable Shoulder”
- Slope ratios are expressed, in feet, as 3H:1V, 4H:1V, 5H:1V. The first number represents the horizontal distance and the second represents the vertical distance (see [Figure 900-1](#)).

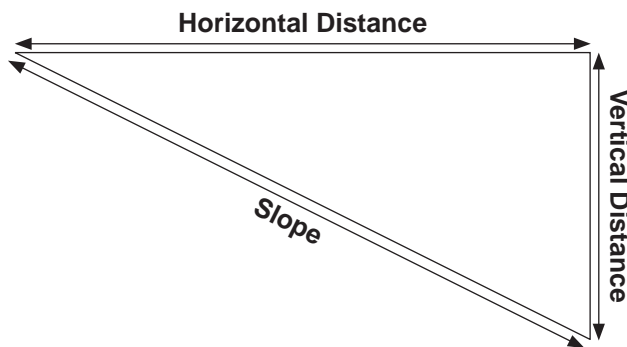

Slope Ratio

Figure 900-1

- For fill sections where the sideslope area includes multiple slope ratios of 4H:1V or flatter (Condition 5), the applicable slope ratio should be determined based on averaging the slope ratios according to the following method:

Slope Averaging

1. $A1/A2 + B1/B2 = C$
2. Slope Average = $\frac{A1+B1}{C}$

Where:

- A1 = width of the first slope section, measured from the beginning of the sideslope to the beginning of the next slope section
- A2 = horizontal value in the slope ratio corresponding with A1
- B1 = width of the next slope section, measured from the beginning of the section to the face of utility object
- B2 = horizontal value in the slope ratio corresponding with B1

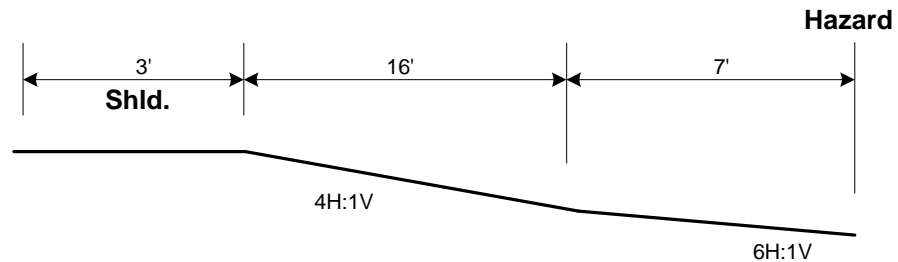
Example:**Slope Averaging***Figure 900-2*

$$A1 = 16, A2 = 4, B1 = 7, B2 = 6$$

$$1. \quad 16/4 + 7/6 = 4 + 1.17 = 5.17$$

$$2. \quad 23/5.17 = 4.45 \text{ Average slope} = 4:1$$

- The Recovery Area Formula (see [900.07](#)) is normally used when the cut section foreslope (Condition 4) or the fill section sideslope (Condition 6) is steeper than 4H:1V, but not steeper than 3H:1V. When using the Recovery Area Formula to calculate the Clear Zone, if the highway section includes a ditch, slope data for the backslope must also be collected and factored into the formula.
- When auxiliary lanes for parking, vehicle pull-out, turning, or storage are present, the Control Zone begins at the edge of the through lane. When the Recovery Area Formula is used, the shoulder width distance will include these auxiliary lane widths.
- For managed access city streets that are part of state highways, cities may adopt Control Zone standards that vary from the requirements of this chapter (see [RCW 47.24.020](#)).

(2) Determining the Control Zone Distance for Various Highway Geometric Conditions

Control Zone distance at a particular location is determined using the following methods. Choose one of the six Conditions with matching highway section characteristics and follow the listed steps and instructions. The table referred to in this section is the Clear Zone Distance Table (see [Figure 900-9](#)).

(3) Cut Sections: Conditions 1, 2, 3, and 4

(a) Cut Section: Condition 1

- No ditch
- Backslopes of 3H:1V or flatter

The Control Zone is read directly from the table based on posted speed, average daily traffic (ADT), and backslope.

- Step 1:** Locate posted speed
Step 2: Locate ADT
Step 3: Locate backslope
Step 4: Read CZ directly from table

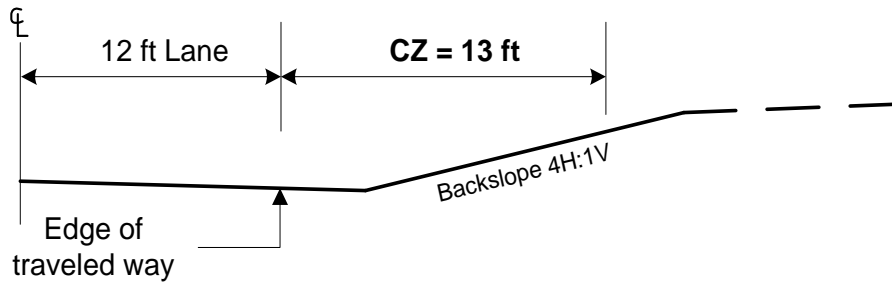
Example:

- Step 1: Speed is 45 mph
 Step 2: Traffic is 1900 ADT
 Step 3: Backslope is 4H:1V
 Step 4: Read 13 feet directly from table
 Control Zone = 13 feet

Control Zone Cut Section: Condition 1*Figure 900-3***(b) Cut Section: Condition 2**

- Ditch foreslopes of 4H:1V or flatter
- For all backslopes, use 10H:1V cut section in calculations

The Control Zone distance is the greater of:

1. Read directly from the table based on posted speed, average daily traffic (ADT), and a backslope of 10H:1V.

Step 1: Locate posted speed

Step 2: Locate ADT

Step 3: Use backslope of 10H:1V

Step 4: Read directly from table

2. Five feet beyond the roadside width.

Step 1: Locate roadside width

Step 2: Add 5 feet to the roadside width

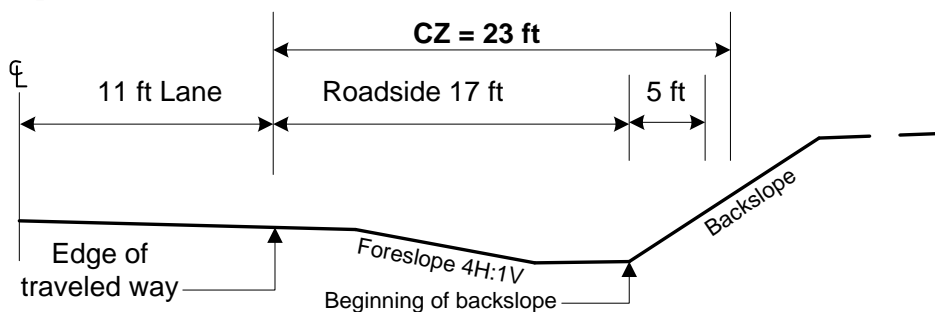
Example:

1. Step 1: Speed is 55 mph
 Step 2: Traffic is 4200 ADT
 Step 3: Foreslope 4H:1V or flatter: use a backslope of 10H:1V (from table)
 Step 4: Read 23 feet directly from table
2. Step 1: Roadside width is 17 feet
 Step 2: 17 feet plus 5 feet = 22 feet

Solution = Greater of: 1. = 23 feet or 2. = 22 feet

Control Zone = 23 feet

Control Zone Cut Section: Condition 2*Figure 900-4*

(c) Cut Section: Condition 3

- Ditch foreslope is steeper than 4H:1V
- Ditch backslope is steeper than 3H:1V

The Control Zone distance is established at 10 feet beyond the beginning of backslope (roadside width).

Step 1: Locate roadside width

Step 2: Add 10 feet to the beginning of backslope (roadside width)

Example:

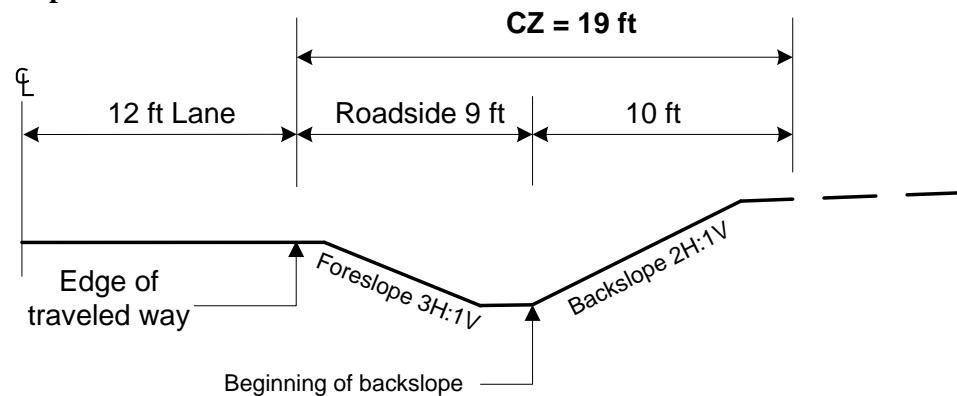

Step 1: Roadside width is 9 feet

Step 2: 9 feet plus 10 feet = 19 feet

Control Zone = 19 feet

Control Zone Cut Section: Condition 3

Figure 900-5

(d) Cut Section: Condition 4

- Ditch foreslope is steeper than 4H:1V, but not steeper than 3H:1V*
- Ditch backslope is 3H:1V or flatter

*Note: For steeper slopes, the Recovery Area Formula may be used as a guide if the difference in elevation between the edge of travelled way and bottom of ditch is 10 feet or less.

The Control Zone distance is the recovery area calculated using the Recovery Area Formula (see 900.07).

Step 1: Locate posted speed

Step 2: Locate ADT

Step 3: Locate backslope

Step 4: Read CZ distance from table

Step 5: Locate roadside width

Step 6: Locate shoulder width

Step 7: Use Recovery Area Formula

Example:

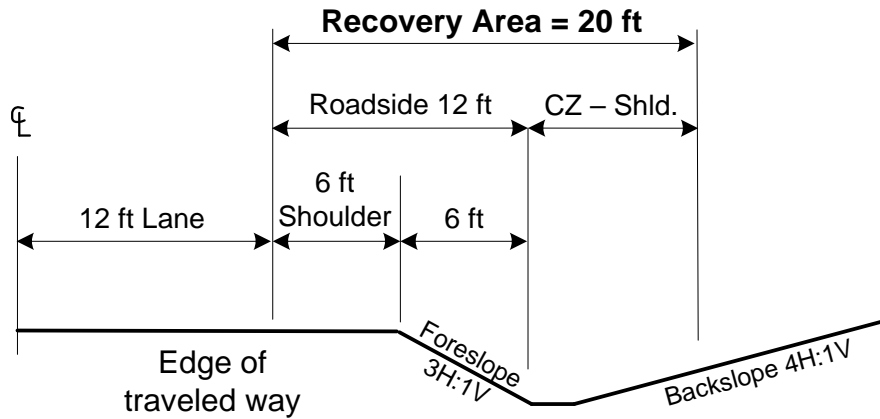

- Step 1: Speed is 40 mph
 - Step 2: Traffic is 3000 ADT
 - Step 3: Backslope is 4H:1V
 - Step 4: Read from table, CZ is 14 feet
 - Step 5: Roadside width is 12 feet (6-foot shoulder + 6-foot horizontal distance)
 - Step 6: Shoulder width is 6 feet
 - Step 7: (12 feet) + (14 feet – 6 feet) = 20 feet
- Control Zone = 20 feet

Control Zone Cut Section: Condition 4
Figure 900-6

(4) Fill Section: Conditions 5 and 6

(a) Fill Section: Condition 5

- Sideslope is 4H:1V or flatter

The Control Zone distance is read directly from the table based on posted speed, sideslope, and average daily traffic (ADT).

- Step 1:** Locate posted speed
- Step 2:** Locate ADT
- Step 3:** Locate sideslope (use slope averaging formula; see [900.06\(1\)](#) when sideslope ratio varies)
- Step 4:** Read CZ directly from table

Example:

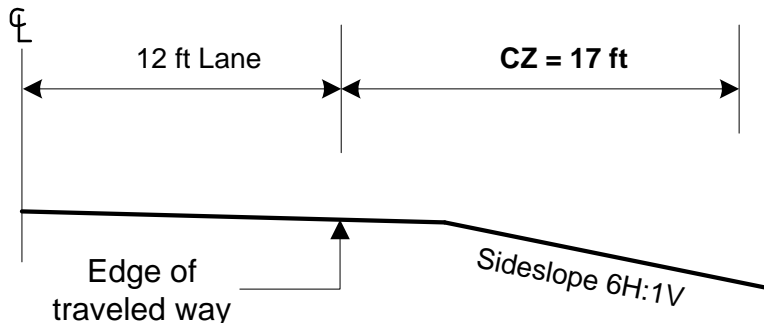

- Step 1: Speed is 50 mph
 - Step 2: Traffic is 320 ADT
 - Step 3: Sideslope is 6H:1V
 - Step 4: Read 17 feet directly from table
- Control Zone = 17 feet

Control Zone Fill Section: Condition 5
Figure 900-7

(b) Fill Section: Condition 6

- Sideslope is 3H:1V or steeper*

The Control Zone distance is the recovery area, calculated using the Recovery Area Formula (see 900.07).

*Note: Recovery Area Formula normally applies to slopes steeper than 4H:1V, but not steeper than 3H:1V. For steeper slopes, the Recovery Area Formula may be used as a guide if the embankment height is 10 feet or less.

For installations where the sideslope is steeper than 3H:1V and the fill height is greater than 10 feet, consult Figure 900-16, Guidelines for Embankment Barrier. If embankment barrier is not recommended, Control Zone is the Recovery Area.

Recovery Area = shoulder width + horizontal nonrecoverable sideslope distance (roadside width) + (Control Zone distance from table – shoulder width)

- Step 1:** Locate posted speed
Step 2: Locate ADT
Step 3: Locate existing ground sideslope
Step 4: Read CZ distance from table
Step 5: Locate roadside width
Step 6: Locate shoulder width
Step 7: Use Recovery Area Formula

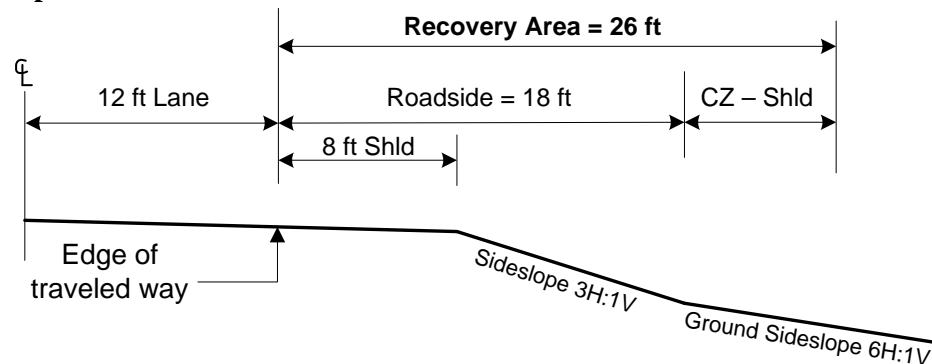
Example:

- Step 1: Speed is 40 mph
 Step 2: Traffic is 3000 ADT
 Step 3: Existing ground sideslope is 6H:1V
 Step 4: Read from table, CZ is 16 feet
 Step 5: Roadside width is 18 feet
 Step 6: Shoulder width is 8 feet
 Step 7: (18 feet) + (16 feet – 8 feet shld) = 26 feet
 Control Zone = 26 feet

Note: For positive (+) ground sideslopes, use Condition 3 or 4.

Control Zone Fill Section: Condition 6*Figure 900-8*

Clear Zone Distances for State Highways Outside Incorporated Cities*
(In feet, from edge of traveled way**)

Posted Speed mph	Average Daily Traffic	Cut Section (Backslope) (H:V)						Fill Section (H:V)					
		3:1	4:1	5:1	6:1	8:1	10:1	3:1	4:1	5:1	6:1	8:1	10:1
35 or Less		The Control Zone distance is 10 feet											
40	Under 250	10	10	10	10	10	10	***	13	12	11	11	10
	251-800	11	11	11	11	11	11	***	14	14	13	12	11
	801-2000	12	12	12	12	12	12	***	16	15	14	13	12
	2001-6000	14	14	14	14	14	14	***	17	17	16	15	14
	Over 6000	15	15	15	15	15	15	***	19	18	17	16	15
45	Under 250	11	11	11	11	11	11	***	16	14	13	12	11
	251-800	12	12	13	13	13	13	***	18	16	14	14	13
	801-2000	13	13	14	14	14	14	***	20	17	16	15	14
	2001-6000	15	15	16	16	16	16	***	22	19	17	17	16
	Over 6000	16	16	17	17	17	17	***	24	21	19	18	17
50	Under 250	11	12	13	13	13	13	***	19	16	15	13	13
	251-800	13	14	14	15	15	15	***	22	18	17	15	15
	801-2000	14	15	16	17	17	17	***	24	20	18	17	17
	2001-6000	16	17	17	18	18	18	***	27	22	20	18	18
	Over 6000	17	18	19	20	20	20	***	29	24	22	20	20
55	Under 250	12	14	15	16	16	17	***	25	21	19	17	17
	251-800	14	16	17	18	18	19	***	28	23	21	20	19
	801-2000	15	17	19	20	20	21	***	31	26	23	22	21
	2001-6000	17	19	21	22	22	23	***	34	29	26	24	23
	Over 6000	18	21	23	24	24	25	***	37	31	28	26	25
60	Under 250	13	16	17	18	19	19	***	30	25	23	21	20
	251-800	15	18	20	20	21	22	***	34	28	26	23	23
	801-2000	17	20	22	22	23	24	***	37	31	28	26	25
	2001-6000	18	22	24	25	26	27	***	41	34	31	29	28
	Over 6000	20	24	26	27	28	29	***	45	37	34	31	30
65	Under 250	15	18	19	20	21	21	***	33	27	25	23	22
	251-800	17	20	22	22	24	24	***	38	31	29	26	25
	801-2000	19	22	24	25	26	27	***	41	34	31	29	28
	2001-6000	20	25	27	27	29	30	***	46	37	35	32	31
	Over 6000	22	27	29	30	31	32	***	50	41	38	34	33
70	Under 250	16	19	21	21	23	23	***	36	29	27	25	24
	251-800	18	22	23	24	26	26	***	41	33	31	28	27
	801-2000	20	24	26	27	28	29	***	45	37	34	31	30
	2001-6000	22	27	29	29	31	32	***	50	40	38	34	33
	Over 6000	24	29	31	32	34	35	***	54	44	41	37	36

*This figure also applies to limited access state highways in cities and median areas on managed access state highways in cities. (See the [Design Manual](#) for guidance on managed access state highways within incorporated cities.)

**Traveled way: The portion of the roadway intended for the movement of vehicles, exclusive of shoulders and lanes for parking, turning, and storage for turning.

***When the fill section slope is steeper than 4H:1V, but not steeper than 3H:1V, the Control Zone distance is modified by the Recovery Area Formula and is referred to as the recovery area. The basic philosophy behind the Recovery Area Formula is that a vehicle can traverse these slopes but cannot recover (control steering); therefore, the horizontal distance of these slopes is added to the Control Zone distance to form the recovery area.

Clear Zone Distance Table
Figure 900-9

900.07 Recovery Area

Note: [Figure 900-10](#) clarifies the Recovery Area Formula.

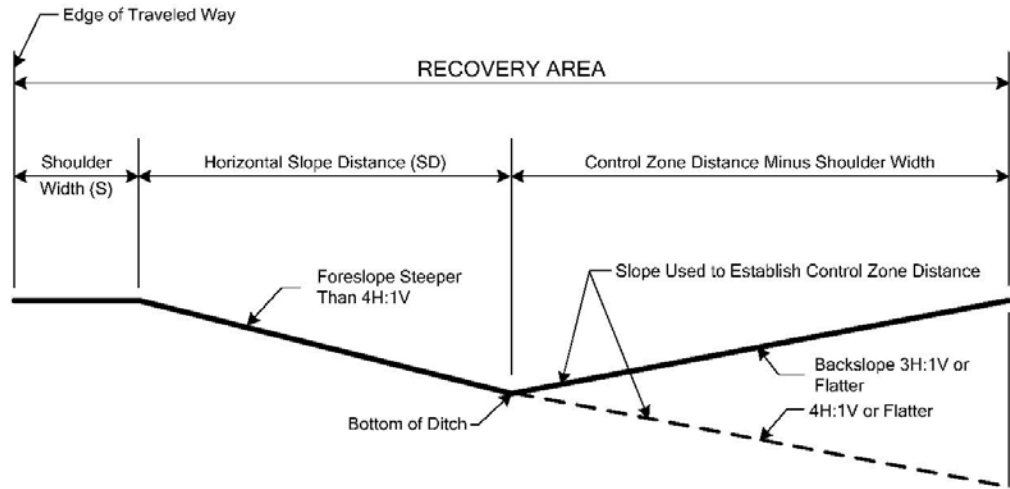

Formula:
 Recovery Area =
 (shoulder width) + (horizontal distance) + (Control Zone distance – shoulder width)

Recovery Area
 Figure 900-10

Example

Fill Section (Slope 3H:1V or Steeper)	
Conditions	Speed – 45 mph Traffic – 3000 ADT Slope – 3H:1V
Criteria	Slope 3H:1V – Use Recovery Area Formula
RECOVERY AREA = 29 ft	
Recovery Area = (shoulder width) + (horizontal distance) + (Control Zone distance – shoulder width)	
29 feet =	8 + 12 + (17 – 8)

Recovery Area Calculation
 Figure 900-11

900.08 Supplemental Utility Design Information

The following items are provided as a guide to the utility industry for consideration during design and maintenance of its facilities.

(1) Horizontal Curves

If it is not necessary, do not place utility objects on the outside of horizontal curves.

(2) Public Grade Intersections

When possible, design the facility placing utility objects outside the turn radius area of public grade intersections (see [Figure 900-12](#)). If this is not possible, the facility should, at a minimum, be placed outside the Control Zone in relation to the state highway. If the intersecting road is a local agency roadway with a stop condition at the state highway intersection, the facility must be placed at least 10 feet from the edge of the travelled way for the portion of the local agency roadway leg within WSDOT ownership. If WSDOT ownership of the local agency roadway leg exceeds more than 250 feet back from the stop bar at the highway intersection, contact [HQ Utilities](#) for additional guidance. Applicable local agency standards shall apply outside of WSDOT-owned right of way.

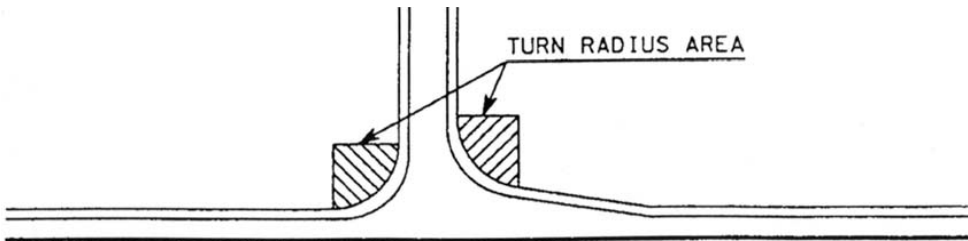

Intersection Radius Area

Figure 900-12

(3) Placement of Utility Objects Behind Barriers

Do not place objects within the deflection distance of any barrier used.

(4) Service Poles

Place service poles on owners' property, not state right of way. Consideration should be given to placing the service pole as far as possible from the highway right of way—at a minimum, outside the Control Zone.

(5) Pole Design

When Control Zone requirements within the highway right of way are tight, consideration should be given to alternative pole designs that may allow construction at or close to the right of way line (see [Figure 900-13](#)).

(6) Guy Poles/Wires

Guy poles and/or wires are not to be installed between the pole line and highway lanes unless the guy pole/wire is outside the Control Zone. Guy and anchor wires are considered hazard objects.

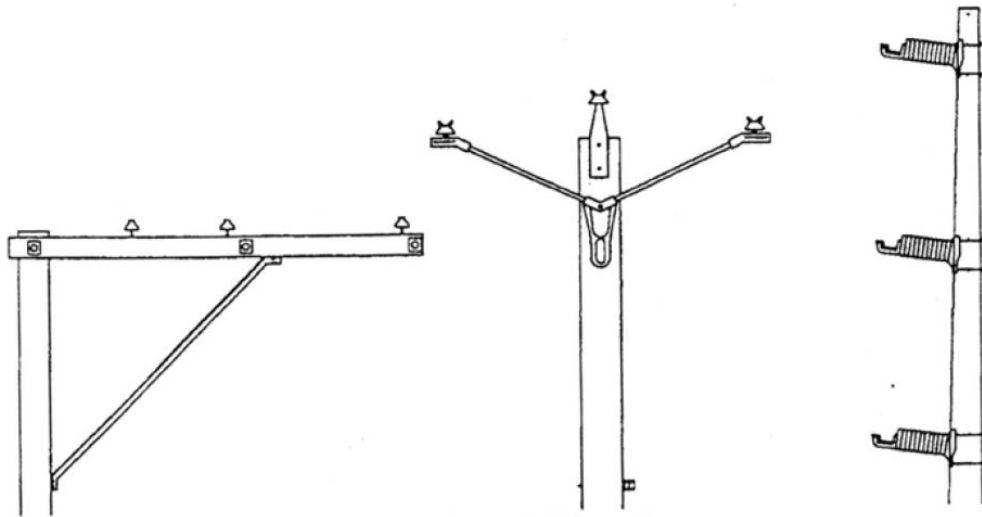

Alternative Pole Designs
Figure 900-13

(7) Utility Location Markers

Markers used to identify or protect utility facilities, such as a telephone pedestal, may not be larger than a 4 × 4 (16 sq. inches) wood post unless drilled to accommodate breakaway. Solid markers, such as concrete, may not be used. Telephone pedestals that meet the breakaway criteria are acceptable within the Control Zone.

Post Size	Hole DIA
4 × 4	—
4 × 6	1½ inch
6 × 6	2 inch
6 × 8	3 inch

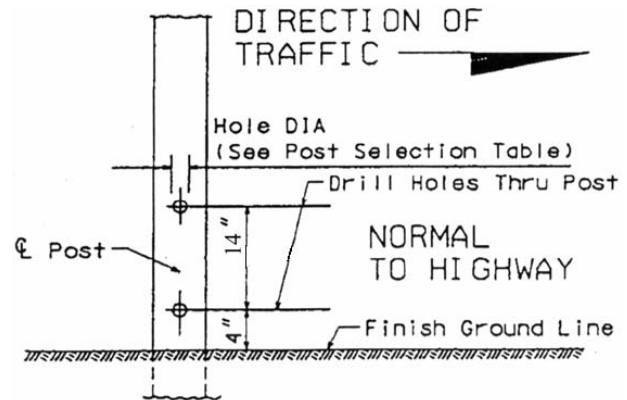

Note: Posts that are larger than 6 × 8 require barrier protection when located within the Control Zone.
(See the [Standard Plans](#) for further guidance.)

Wood Post Breakaway Details
Figure 900-14

900.09 Project Applications

(1) New Utility Facility Construction

- (a) The utility constructs a new line or extends an existing line within highway right of way.
1. New utility objects will be constructed outside of the Control Zone unless a variance is approved.
 2. The utility will submit to WSDOT the following data if applicable:
 - Utility Accommodation Application.
 - Mitigation proposals for existing objects, if applicable, including plans.
 - Submittals supporting variance, if applicable, as specified in [900.11](#).
 - A completed copy of the Utility Object Relocation Record listing new utility objects.

(2) Existing Utility Reconstruction

- (a) The utility replaces twenty-five percent (25%) or more of the existing poles or towers within any mile. Periodic pole or tower replacement is not included.
1. Utility objects will be relocated outside of the Control Zone unless a variance is approved.
 2. The utility will submit to WSDOT the following data if applicable:
 - Utility Accommodation Application.
 - Mitigation proposals for existing objects, including plans.
 - Submittals supporting variance, as specified in [900.11](#).
 - A copy of the completed Utility Object Relocation Record.

(3) Utility Relocation Required by WSDOT Improvement Projects

- (a) Conditions: WSDOT may address individual safety items.
1. WSDOT will conduct an accident analysis to determine spot safety improvement needs.
 2. Any individual Location I or Location II Objects that demonstrate a need for adjustment will be relocated outside of the Control Zone or mitigated (see [900.03](#)) in conjunction with the project.
 3. No consideration for variance will be given until all alternative measures have been investigated and determined not feasible.
 4. At the time the project preliminary estimate is prepared, WSDOT will notify the utility of the project and request that the utility commit to a course of action.
 5. The utility will submit to WSDOT the following data if applicable:
 - Utility Accommodation Application.
 - Mitigation proposals for existing objects, if applicable, including plans.
 - Submittals supporting variance, if applicable (see [900.11](#)).
 - A copy of the completed Utility Object Relocation Record.

- (b) Conditions: WSDOT addresses safety items.
1. The utility will adjust all identified Objects to comply with Control Zone requirements.
 2. No consideration of variance will be given until all alternative measures have been investigated and determined not feasible.
 3. At the time the project preliminary estimate is approved, WSDOT will notify the utility of the project scope and the Location I Object and Location II Object responsibility.
 4. When the project Design Summary is completed, WSDOT will request that the utility adjust all Location I Objects and selected Location II Objects.
 5. The utility will submit to WSDOT the following data if applicable:
 - Utility Accommodatin Application.
 - Mitigation proposals for existing objects, if applicable, including plans.
 - Submittals supporting variance, if applicable (see 900.11).
 - A copy of the completed Utility Object Relocation Record.

900.10 Completing the Utility Object Relocation Record

A completed Utility Object Relocation Record (see [Appendix B](#)) form shall accompany any utility submittals to WSDOT as part of a Franchise or Permit Amendment, Franchise Renewal/Consolidation, or highway project-related relocation coordination when objects exist or are proposed to be in Location I or II. Following is the information needed on the form.

(1) Form Headings

Enter the utility owner and location and other identification information on the top left side of the form.

Enter the milepost limits beside the proper type of construction on the top right side of the form.

(2) Existing Object Information

Identify the utility object by entering the milepost, pole or object number, location left or right of highway centerline (left or right is determined facing the increasing highway milepost), type of object (i.e., transmission, guy), and whether it is owned, jointly owned, or leased.

(3) Roadway Data

The speed, average daily traffic (ADT), and the right of way width from centerline can be obtained from the Region Utilities Office. Also, ADTs can be found in the Annual Traffic Report and highway speed in the State Highway Log. These can be obtained at the Transportation Data and GIS Office website:

www.wsdot.wa.gov/mapsdata/tdgo_home.htm

(4) Field Measurements

Enter the slope and distance measurements required to calculate the Control Zone distances (see [900.06](#)).

(5) Control Zone Calculations

From the Control Zone Distance section (see [900.06](#)):

- Enter the Condition number that was used to calculate the Control Zone distance.
- Enter the calculated Control Zone distance.
- Enter whether the object is Location I or Location II.

Notice that the Location III Objects do not need to be entered on the form.

(6) Planned Object Correction

This section is used by the utility to record, on the Utility Object Relocation Record form (see [Appendix B](#)), its decision on how the utility object will be corrected.

- For utility objects that will be relocated outside the Control Zone, (see [900.03](#)), mark the relocated distance in the Reloc. Dist column.
- For utility objects that will be corrected with the use of an alternative measure, mark the Alternate Measure column.
- If mitigation is the alternative measure chosen, justification for the use of mitigation and a plan showing proposed mitigation are required for WSDOT review and approval.
- For individual utility Location I Objects that cannot be relocated outside the Control Zone or corrected with the use of an alternative measure, and for which a variance will be requested, mark the LOC I VAR. column.
- To be considered for a variance, the utility must submit to WSDOT a request for a variance together with the required justification (see [120.14](#)).

For individual utility Location II Objects that cannot be relocated outside the Control Zone or corrected with the use of an alternative measure and for which a variance will be requested, mark the “LOC II Variance” column.

900.11 Variance

WSDOT recognizes that conditions may arise that make it impracticable to comply with Control Zone requirements. Variances from such compliance may be allowed on a case-by-case basis when clearly justified, as specified in the following sections.

Examples of conditions rendering compliance impracticable include:

- Inadequate right of way to accommodate utility objects outside the Control Zone.
- Physical limitations due to terrain or topography.
- Unjustifiably high costs to relocate or underground the utility facility.

(1) Utility Object Location Category Reference

(a) Location I Utility Objects

Fixed utility objects located within the Control Zone in the following areas:

- The outside of horizontal curves where advisory speeds for the curve are 15 mph or more below the posted speed limit of that section of highway.
- Within the turn radius area of public road grade intersections.

- Where a barrier, embankment, rock outcropping, ditch, or other roadside feature is likely to direct a vehicle into a utility object.
- Closer than 5 feet horizontal beyond the edge of the usable shoulder.

(b) Location II Utility Objects

Fixed utility objects located within the Control Zone that are not classified as Location I or Location III Objects.

(c) Location III Utility Objects

Fixed utility objects that are:

- Located outside the Control Zone.
- Within the Control Zone and mitigated by an alternate countermeasure consistent with the state's *Utilities Accommodation Policy*.

900.12 Variance Request for Location I Objects

Compliance with the WSDOT Control Zone Policy requires adjustment of all Location I Objects outside of the Control Zone. Exceptions may be granted only after an independent analysis and recommendation is completed by a WSDOT review team, including the Region and HQ Utilities Engineers, in consultation with WSDOT subject matter experts as appropriate for the location. Reviews for this purpose will consider relevant highway operational and geometric factors, accident history, and assessment of possible mitigation strategies. Exceptions will be allowed only if it is determined, at the department's discretion, that no reasonable alternative measures are available, with safety being the primary consideration. These requests will be assessed on a case-by-case basis, and will require specific information and documentation from the utility as determined by the review team. Documentation for the review team's investigation and recommendations should be included in the franchise or permit file.

The Utility will be required to complete a Control Zone Variance Request – Justification for Location I variances. The Region Utilities Engineer may determine additional information is necessary to consider the Location I variance request. Submittal of a variance request does not mean approval will be given.

900.13 Variance Request for Location II Objects

The primary objective for Location II Objects is to relocate them outside of the Control Zone. If achieving this objective is not possible or practicable, the Region Utilities Engineer may authorize variance requests for Location II Objects based on the justification criteria described below.

There are two categories of Location II Objects addressed in this section:

- Location II Objects that have no recorded accident history and are not located within an area of concentrated utility object crashes; and
- Location II Objects that do have recorded accident history, are located within an area of concentrated utility object crashes, or are otherwise determined by WSDOT to be appropriate for additional justification, as specified for this category of objects.

(1) Location II Objects With No Accident History

The following covers Location II Objects that have no accident history and are not located within an area of concentrated utility object crashes.

The Utility will be required to complete a Control Zone Variance Request – Justification to initiate any requests for Location II variances, or to use the Roadside Safety Analysis Program (RSAP) to support the justification.

For this category of Location II Objects, Control Zone Variance Request Justification may be substituted with an analysis of alternative mitigation strategies using the RSAP, described below, to support selection of the most effective mitigation strategy.

Alternative mitigation strategies include:

1. Placing the utility line underground.
2. Reducing the number of utility objects through joint use, increasing span lengths, and/or placing utility objects on only one side of the road.
3. Increasing the lateral offset of utility objects from the edge of the traveled way to the extent possible.
4. Locating the object within an inaccessible area such as toward the top or on the top of cut slopes.
5. Installing protective devices such as guardrail, berms, traffic barriers, or impact attenuators. (Refer to [Design Manual Chapter 1600](#) for Guidelines for Embankment Barrier).
6. Using a breakaway design.
7. Other location-specific measures that may be evident or identified by WSDOT.

RSAP analysis can support justification for a particular alternative; however, it is not necessarily the deciding factor in WSDOT's review. Objects subject to RSAP analysis will be independently reviewed by the Region Utilities Engineer to identify (1) any unique location characteristics that should be more closely considered beyond the minimum required justification, and/or (2) opportunities for mitigation measures not considered in the application.

(2) Location II Objects With Accident History

The following covers Location II Objects with accident history, that are located within an area of concentrated utility object crashes, or that are determined by WSDOT to be appropriate for additional justification.

A completed Control Zone Variance Request – Justification should be submitted to initiate any requests for Location II variances.

(3) Roadside Safety Analysis Program

The Roadside Safety Analysis Program (RSAP) is a benefit/cost analysis program developed under NCHRP Project 22-27, and endorsed in the AASHTO *Roadside Design Guide*, as a tool for comparative analysis of alternative site-specific treatments to enhance roadside safety. The intent of the program is to identify the most cost-effective engineering treatments to address roadside safety, and compare the benefits and costs of implementing multiple alternatives.

RSAP analyzes alternatives based on certain factors and location characteristics such as highway operation; installation and maintenance costs; traffic growth; project life; probable collision frequency and severity; and the expected reduction in the future cost of crashes associated with each alternative.

The default values provided by the RSAP system should be used, except for the following factors:

- **Traffic Growth Rate:** Obtain percentage of annual growth from the Region Traffic Office or Transportation Data and GIS Office.
- **Cost of installation, repair, maintenance, salvage value, and life of object:** RSAP provides default values, but actual values should be used if known.

Note: Additional guidance specifying required RSAP submittals will be added to Chapter 9. HQ Utilities is currently coordinating training by the program developer and will establish this additional guidance once training is complete.

The RSAP program and information regarding its use may be accessed at the following website: <http://rsap.roadsafellc.com>

AASHTO American Association of State Highway Transportation Officials.

Abandoned Facilities Those facilities located within WSDOT right of way, on an easement or other property right of the utility, that remain in the right of way after the utility has given the state a quitclaim deed to the property right. The utility is no longer responsible for the facility, and all costs for future impacts created by the facility are now borne by the state.

Acceptance of Assignment See [Transfer of Ownership](#).

Access Break Creation of an ingress or egress point at a location other than a designated interchange or intersection, such as the construction or installation of a utility.

Access Control Tracking System A database system used to determine the access level of highway right of way and identify existing approach rights, which is managed by the HQ Design Office, Access and Hearings Section.

Accommodation Application An application submitted by a utility, or a utility's agent working on behalf of the utility, requesting permission to install a utility within the operating highway right of way.

Accommodation Document A generic term denoting a utility franchise, Franchise Amendment, Franchise Renewal, Franchise Consolidation, or permit. Accommodation documents are legal and binding agreements between the utility and WSDOT that describe in detail the terms and conditions under which a utility organization will be allowed to install a utility within the operating highway right of way.

Accommodation Process The process of receiving, reviewing, approving, inspecting, and accepting a utility installation.

Addenda/Addendum An addendum is any document or plan that revises, modifies, or supplements a previously approved utility accommodation document, becoming part of the approved utility installation.

Agreement Execution Date The signature date of the final party to sign the agreement.

Alternate Measures Alternatives to the relocation of nontraversable utility objects to outside the Control Zone; methods used to protect, reduce, or eliminate Location I or II Objects.

Alternative Countermeasures See [Alternate Measures](#).

Annexation The process of expansion of a city's boundaries to include land previously outside its jurisdiction.

Approval as to Form Verification of the legality of a document by the Attorney General's Office.

ASCE American Society of Civil Engineers.

Assistant Attorney General (AAG) An attorney assigned to WSDOT by the Attorney General's Office.

At-Risk Utility Object A fixed-surface utility object considered to be installed in a location where the probability of collision by a motor vehicle is high. Examples include a rural Location 1 utility object located within the Control Zone or an urban utility installation located within 10 feet of the face of curb.

Auxiliary Lane That portion of the roadway adjoining the traveled way for parking, speed change, turning, storage for turning, weaving, truck climbing, or for other purposes supplementary to the main line traveled way. (See also [Traveled Way](#).)

Backslope See [Slope](#).

Best Management Practice (BMP) Generally accepted standards of operation that have been tested and proven desirable for future use.

Best Practice See [Best Management Practice](#).

Betterment Any upgrading of the facility being relocated that is not attributable to the highway construction or to meeting current requirements or standards, and that is made solely for the benefit of and at the election of the utility.

Biological Assessment The process used to evaluate the potential impacts of project work on listed and proposed wildlife, fish, plant species, and critical habitats in the vicinity of the project area.

Bore Pit Defined as both a receiving and a launching pit for trenchless construction methods.

Bottom of Ditch The bottom of an open, natural, or constructed drainage route, which may be adjacent to the roadway structure, with the purpose of directing stormwater away from the roadway.

Carrier Pipe A pipe used to transmit a fluid, liquid, gas, or other nonstatic material.

Casing A larger pipe enclosing a carrier pipe, conduit, or duct.

Category The installation category as determined by the impact a proposed utility installation will have upon the operating highway right of way and the transportation facilities located there.

CDF See [Controlled Density Fill](#).

Classification Criteria Criteria used to define how utilities are documented and managed on highway right of way. (See also [Utility Classification Criteria](#).)

Clear Zone See [Control Zone](#).

Compensatory Rights The right of a utility owner to be compensated for impacts to a utility that may need to be modified or relocated as a result of a WSDOT highway improvement project or other work. (See also [Property Right](#).)

Completion of Construction The date when authorized utility work within the operating right of way is completed to the satisfaction of WSDOT as defined by the provisions of the approved accommodation document.

Conduit A tubular enclosure for protecting wires or cables. (See also [Duct](#).)

Consolidated Franchise A utility franchise that results from the consolidation of multiple utility accommodation documents into a single utility franchise based on the Utility Classification Criteria.

Consolidation The process of combining two or more utility accommodation documents into a single utility franchise.

Consolidation Plan A plan developed cooperatively between a utility and WSDOT for researching and combining all utility accommodation documents into a single consolidated franchise based on the Utility Classification Criteria.

Construction For *highway purposes*, the actual building and all related work, including utility relocation or adjustments, incidental to the construction or reconstruction of a highway project, except for preliminary engineering or right of way work programmed and authorized as a separate phase of work.

For *utility purposes*, the installation of approved utility facilities on highway right of way.

Construction Permit A temporary right of entry to construct highway improvements on local agency rights of way. WSDOT has no property rights or utility accommodation approval authority within construction permit areas.

Continuing Contract A contract where a consultant or contractor performs specific services at an agreed price for an organization for a specific time period. The time period would normally be for one year or more.

Control Zone (CZ) The roadside area defined by a calculated Control Zone distance where the placement of utility objects is controlled or prohibited. In this manual the term is used interchangeably with clear zone (see Chapter 9).

Control Zone Alternative Countermeasures See [Alternate Measures](#).

Control Zone Guidelines A guide jointly developed by the utility industry and WSDOT defining the safe placement of aboveground utility objects within the highway right of way.

Control Zone Variance Any aboveground utility installation installed or proposed to be installed inside the Control Zone as an exception to policy. Variance request documentation must be submitted by the utility and reviewed and approved by WSDOT.

Controlled Density Fill (CDF) A lean concrete mixture that may be broken and removed easier than regular concrete mixes and frequently cures rapidly. CDF is used for certain trench backfill applications.

Controlled Low-Strength Material (CLSM) See [Controlled Density Fill](#).

Corrective Action Plan A document that identifies utility objects located in Location I or II areas to define *where*, *how*, and *when* noncompliant utilities will be relocated or mitigated. A Corrective Action Plan shall be required when a utility reconstruction project is proposed or when a franchise is being renewed or consolidated. The plan and schedule shall be developed cooperatively between the utility and WSDOT. Corrective Action Plans are to be attached to a Franchise Renewal or Consolidation document as an exhibit. The plan correction period will not exceed five years.

Corrective Measures Plan See [Corrective Action Plan](#).

Cost-Effective Selection Procedure See [Cost-Effectiveness Selection Procedure](#).

Cost-Effectiveness Selection Procedure (CESP) A rational methodology developed by AASHTO for comparing roadside improvement alternatives. AASHTO's methodology, published as [Appendix A](#) to its 2002 (see current version) *Roadside Design Guide*, can be used manually or through a computer program (ROADSIDE or the newer Roadside Safety Analysis Program-RSAP). Refer to Chapter 9, Control Zone, for detailed information.

Cost to Cure Value of real property or rights to which a damaged party is entitled.

Cover The depth of material above the top of a buried utility installation up to the finished surface, either ground line or roadway surface.

Critical Fill Slope See [Slope](#).

Deactivated Facilities Those facilities that are no longer active, but remain in WSDOT right of way. They are still owned by the utility and the utility is responsible for all costs for impacts caused by these facilities to a project or to another utility's relocation efforts. At the discretion of the state, the utility will still be required to relocate or remove deactivated facilities.

Deactivated Utility A utility facility no longer being used by the utility owner. The utility owner continues to maintain ownership and responsibility for the facility's future disposition.

Department Policy In this manual, those policies established by WSDOT for the use of the highway right of way based on applicable federal and state laws, codes, and other accepted guidelines.

Direct Bury Placement of a utility without the protection of a conduit or similar protection; or, a cable or conduit placement method where a vibrating hollow tooth creates a void area and the cable or conduit, fed from a spool, is placed at the lower portion of the ripper without excavating material.

Disconnected Facilities See [Deactivated Facilities](#).

Drop Service Connection A utility service connection, usually originating from an overhead distribution line that drops from the pole line and continues underground to the service location.

Duct A tubular enclosure for protecting wires or cables. (See also [Conduit](#).)

Easement A legal document transferring a defined property right to a third party for a specific purpose. WSDOT generally does not grant easements for utility installations within the operating right of way.

Edge of Traveled Way The outside edge of the roadway designated for normal vehicular travel (also referred to as the fog line).

Emergency Repair Damage to a utility that requires immediate repair. Immediate repair is defined as work that, if not undertaken as soon as possible, will cause severe or catastrophic damage to a utility's facilities or its customers, or place the general public in danger of being harmed.

Encasement A structural element surrounding a pipe.

Entity Pool See [Governmental Entity Pool](#).

Environmental Documents Documents prepared by a project owner acknowledging impacts that will result from a proposed project. Documents are reviewed and approved by regulatory agencies prior to any work being performed. They include Environmental Assessments (NEPA), SEPA Threshold Determinations, (Determination of Significance or Determination of Non-Significance) and associated Environmental SEPA Checklists, Draft and Final Environmental Impact Statements (EISs), Section 4(f) Evaluations, Section 106 Reports, Environmental Justice Reports, and other documents prepared in response to state or federal environmental requirements.

Environmental Permit A document required by law that authorizes a specific type of activity under certain environmental conditions. If required, environmental permits are generally needed prior to the start of any highway construction work, including utility work. Such work is to be included under WSDOT's environmental permits.

Extension of Time An extension of the one-year allotted time period to begin construction of an approved utility installation.

Facilities A general term referring to *highway appurtenances* necessary for the operation of the highway, such as structures, drainage facilities, traffic signals, and similar objects or devices.

For *highway real estate purposes*, the term does not include pit sites, park & ride lots located outside the highway right of way, or other sundry sites.

For *utility purposes*, the term refers to delivery lines and all appurtenances necessary or incidental to the operation of the utility system, such as poles, valves, junction boxes, conduits, and so on.

FHWA The U.S. Department of Transportation Federal Highway Administration, which oversees federal funding to the states. The FHWA controls all full control limited access Interstate freeways and has oversight for NHS highways.

Fill Slope See [Slope](#).

Fixed Object A fixed feature that, when struck, can result in unacceptable impact forces on a vehicle's occupants. A fixed feature can be either natural or constructed.

Fog Line The outside edge of the roadway designated for normal vehicular travel (also referred to as the edge of traveled way or edge stripe).

Foreslope See [Slope](#).

Franchise Consolidation A franchise that has combined all franchises, franchise amendments, and permits into a single franchise document based on the Utility Classification Criteria.

Franchise Period The amount of time a franchise is authorized before it expires: usually 25 years or as determined by WSDOT.

Full Access Control, Limited Access Right of Way Highways or freeways wherein access rights have been acquired by WSDOT, where the facility is accessible only from designated locations (interchanges).

Geographic Information System (GIS) An electronic mapping system used by WSDOT to detail boundaries of tribal organizations, environmentally sensitive areas, and numerous other items using global positioning techniques.

Governmental Entity Pool A group of public agencies joined together for the purpose of sharing risk and reducing insurance expenses.

High-Risk Utility Object A fixed-surface utility object that has documented collision history.

HMA Hot Mix Asphalt (also known as ACP or Asphalt Concrete Pavement).

Holder Table A part of the UFP database table that contains the names of utility owners that have utility accommodation documents with WSDOT (also known as the UFP Holder Table).

Horizontal Directional Drilling (HDD) A trenchless construction method allowing a driller to “steer” the drill head and thus place pipe material along a desired path (also used as an alternative to open cutting). Allows utilities to be installed and avoid obstacles such as structure elements or environmentally sensitive areas.

Initial Franchise The first franchise issued to a utility for a particular installation.

Initial Franchise Period The period of time—up to, but not exceeding, 25 years—for which an initial franchise is issued.

Innerduct A multitubular enclosure for protecting wires or cables, located inside a larger conduit or duct.

Joint-Use Agreement An agreement between two utility organizations defining the terms of use of one utility’s facilities by a third party; for example, attachment of fiber optic cable to an existing aerial utility pole plant.

Letter of Understanding A letter prepared by WSDOT and countersigned by the utility owner that describes the scope of, schedule, and responsibility for utility relocation work associated with a highway project.

Level Playing Field (LPF) Software WSDOT’s currently adopted and installed computer software facilitating statewide communications.

Limited Access Right of Way Right of way for which ingress and egress rights to the highway facility have been purchased by WSDOT. For the purposes of utility accommodation, the term limited access includes partial and modified levels of access control.

Location I Utility Objects Aboveground fixed (unyielding, nontraversable) objects located within the Control Zone in the following areas:

- Outside of horizontal curves where advisory speeds for the curve are 15 mph or more below the posted speed limit of that section of highway (the Control Zone is established using the posted speed limit of the highway, not the advisory speed limit).
- Within the turn radius area of public road grade intersections.
- Where a barrier, embankment, rock outcropping, ditch, or other roadside feature is likely to direct a vehicle into a utility object.
- Closer than 5 feet horizontal beyond the edge of the usable shoulder.

Location II Utility Objects Fixed utility objects located within the Control Zone that are not classified as Location I or Location III Objects.

Location III Utility Objects Fixed utility objects that are:

- Located outside the Control Zone.
- Within the Control Zone and mitigated by an Alternate Countermeasure.
- Location II Objects that have been classified as Location III Objects using the Cost-Effective Selection Procedure (see [900.10](#).)

Maintenance Plan A plan defining maintenance methods, frequencies, environmental considerations, and traffic control proposals for utility facilities installed within the highway right of way.

Managed Access Right of Way Highway right of way that has no specified access control measure planned or in place.

Mitigated Object An aboveground utility object within the Control Zone located in an inaccessible area or behind a protective device, or that utilizes breakaway design. The location and design of mitigation must be acceptable to and approved by WSDOT.

MUTCD *Manual on Uniform Traffic Control Devices*, published by the Federal Highway Administration (FHWA).

NEPA National Environmental Policy Act: The Policy that requires assessment and publication of environmental impacts related to any federally funded project.

NHS National Highway System: Federally funded highways that are part of the National Defense Highway System.

Non-Operating Right of Way Property owned by WSDOT not strictly used for highway purposes, such as pit sites, park & ride lots, transit facilities, and other sundry sites located outside of operating right of way.

Nonrecoverable Slope See [Slope](#).

Nonstandard Agreement An agreement (1) prepared not using a preprinted standard form, which is developed to meet the specific needs of a particular project, (2) utilizing a preprinted standard form that has been modified, or (3) utilizing a preprinted standard form where the language in Exhibit A contradicts language in the standard form agreement. These agreements require review by the Headquarters [\(HQ\) Utilities, Railroad, and Agreements Section](#) and approval as to form by the Attorney General's Office prior to execution by the regions.

Open Cut Cutting of the existing paved roadway surface as a construction method for open trench placement of a utility.

Open Trench Trenched construction method for placement of a utility (also referred to as trenched construction).

Operating Highway Right of Way WSDOT property set aside strictly for highway purposes, and may include rest areas, view points, and turn-outs.

Overhead Costs Those utility costs that are not readily identifiable with one specific task, job, or work order. Such costs may include indirect labor, benefits, taxes, insurance, and general office expenses.

P.E. Licensed Professional Engineer (also the general title of Project Engineer).

Parent Franchise See [Initial Franchise](#).

Participation To the extent provided by law, funds may be used to reimburse or to make payments to the utility on projects. It also refers to the sharing of expenses proportioned in relation to the legal responsibility of the parties.

Pipeline Any pipe, regardless of material, that conveys a utility across or along the highway operating right of way. This includes innerducts, conduit, carrier pipe, and encasement pipe.

Plowed Installation See [Direct Bury](#).

Preliminary Engineering Locating; surveying; preparing Plans, Specifications, and Estimates (PS&E); and other related preparatory work in advance of construction operations.

Prescriptive Right A property right, granted by a court of law, that provides certain property rights to an individual, company, or corporation. If no judgment has been issued, there is no Prescriptive Right, only a Prescriptive Claim. The claim must be brought and argued before a court for a judgment to be issued. For a Prescriptive Claim to be valid, it must be open, notorious, and adverse. Contact [HQ Utilities](#) for additional guidance.

Private Facilities Those facilities that are privately owned, located on the owner's land, devoted exclusively to private use, and that do not directly or indirectly serve the public. When relocation of private facilities is necessary, the relocation shall be handled as part of the right of way negotiations, using the provisions of 23 CFR Part 645A as a guide to establish a cost to cure.

Project In this manual, may refer to a highway improvement project or a utility installation project.

Property Right The right or interest that a party (grantee) has in a parcel of real property. (See also [Compensatory Rights](#).)

Public Utility A "not for profit" public, locally regulated utility service provider.

Quitclaim Deed (QCD) A legal document that transfers a grantor's interest in a land parcel to a second party, a grantee. The QCD must be signed by the state and the utility/grantor and recorded with the appropriate jurisdiction. It conveys the rights, title, and interest of the utility/grantor in a particular piece of property or property right, owned by the utility/grantor on the effective date of the deed, as fully and effectively as a Warranty Deed (may also convey rights from the state to others).

Recoverable Slope See [Slope](#).

Recovery Area In reference to the Control Zone, the Recovery Area is the minimum target value used in utility object location when a fill slope between 4H:1V and 3H:1V starts within the Control Zone.

Region As used in this manual, the region shall refer to WSDOT's seven organizational areas: Northwest-NWR in Seattle; Olympic-OR in Olympia; North Central-NCR in Wenatchee; Southwest-SWR in Vancouver; South Central-SCR in Yakima; Eastern-ER in Spokane; and Urban Corridors Office-UCO in Seattle.

Region Utilities Engineer Region WSDOT representative responsible for oversight and coordination of the state Utilities Accommodation Policy within a designated region of the state. Coordinates with local transportation engineering elements, utility representatives, the State Utilities Engineer, and others as needed.

Reimbursable Costs Any expended costs the state or utility is legally entitled to recover from the other party. Utility reimbursable agreements, both preliminary engineering and construction, are limited to those costs incurred subsequent to the state's written authorization to proceed.

Relocation The adjustment of utility facilities required by the highway project. This includes removing and reinstalling the facilities; acquiring necessary property rights on the new location; moving or rearranging existing facilities; or changing the type of facility, including any necessary safety and protective measures. It shall also mean constructing a replacement facility functionally equal to the existing facility, where necessary, for continuous operation of the utility service, the project economy, or staging highway construction.

Relocation Reconstruction Criteria Defines when proposed utility reconstruction must include relocation of the aboveground utility to meet Control Zone Guidelines (related to WSDOT's Control Zone Policy).

Replacement in Kind A replacement that satisfies the design specifications.

Road Approach An access point from a public road or private property adjacent to the highway. Access permits are issued by WSDOT for some types of road approaches.

Roadbed See [Roadway Prism](#).

Roadside The area between the edge of the roadway shoulder and the right of way line and unpaved medians on multilane highways. (See [WAC 468-34-110\(9\)](#) for roadside and [WAC 468-34-110\(13\)](#) for clear roadside policy.)

Roadway The portion of a highway, including shoulders, for vehicular use. A divided highway has two or more roadways, per [WAC 468-34-110\(7\)](#).

The portion of the right of way within the outside limits of the sideslopes (see the [Construction Manual](#)).

Roadway Prism The area within the right of way that supports the paved roadway between the bottom of ditch and the toe of slope. Includes subgrade, base courses, surfacing courses, pavement, and roadway sideslopes.

Roadway Structure See [Roadway Prism](#).

Route Jurisdiction Transfer (RJT) A roadway whose jurisdictional ownership is transferred from a local agency to WSDOT or from WSDOT to a local agency.

Salvage Credit The amount received by the utility from the sale of any portion of a utility's facility that has been removed or the amount at which the recovered material (if retained for reuse) is credited to the utility's accounts.

Same-Side Service Connection A connection from a utility main to a customer service that does not involve a roadway crossing.

Scenic Classification A visual scaling system that defines the scenic quality of various portions of a roadway and limits, to varying degrees, the ability to install an aerial utility upon the right of way.

SEPA State Environmental Policy Act: The policy that directs state and local decision makers to consider the environmental consequences of actions. The Environmental Policy Act Rules ([WAC 468-12](#)) integrate the procedures of SEPA into the programs, activities, and actions of WSDOT.

Service Connection A connection from a utility main to a customer service.

Service Stub-Out Preinstalled service connection from a utility main at a predetermined location that allows the utility to make a service connection to the main without the need to access the main itself. They are usually associated with longitudinal utility installations within the roadway that would otherwise involve an open cut for the connection.

Shoulder (shld) That portion of a roadway beyond the normal travel width.

Shoulder, Usable That portion of the roadway extending beyond the traveled way or auxiliary lanes that can be used for emergency parking by motorists. Usable shoulder is the average width being used as a shoulder along a section of highway, exclusive of intermittent widened areas, but not to exceed 10 feet in width.

Sideslope The foreslope or backslope. See [Slope](#).

Slope

- **Backslope** A sideslope that goes up as the distance increases from the roadway (cutslopes).
- **Critical Fill Slope** A slope on which a vehicle is likely to overturn. Slopes steeper than 3H:1V are considered critical fill slopes and are not allowed in the Control Zone.
- **Cross Slope** Transverse slope or superelevation described by the roadway section geometry.
- **Fill Slope** That portion of the roadway built upon existing ground to support the structural roadbed. Extends from the top of the shoulder to a point where the slope meets existing ground.
- **Foreslope** A sideslope that goes down as the distance increases from the roadway (fill slopes and ditch slopes).
- **Nonrecoverable Slope** A slope on which an errant vehicle will continue until it reaches the bottom, without having the ability to recover control. Fill slopes steeper than 4H:1V, but no steeper than 3H:1V, are considered nonrecoverable.
- **Recoverable Slope** A slope on which the driver of an errant vehicle can regain control of the vehicle. Slopes of 4H:1V or flatter are considered recoverable.
- **Toe of Slope** The point where the roadway structure meets existing ground line—usually related to a fill section or fill slope.

Spill Prevention, Control, and Countermeasures (SPCC) Plan A project-specific plan to prevent, control, and correct possible contamination from spills of “Hazardous Substances” as defined in [RCW 70.105.010](#).

Standard Form Agreement An agreement prepared using one of the preprinted standard forms available, containing language that complies with applicable state law and WSDOT policy. The agreement form is not to be revised, directly or indirectly, in any manner.

Standard Specifications As used in this manual, shall refer to the current edition of and amendments to WSDOT's *Standard Specifications for Road, Bridge, and Municipal Construction*.

State Highway Log A planning report (available online) prepared by WSDOT's Traffic Data Office that provides statewide roadway data.

State Highway Viewer A computer system (available online) that displays a photo log of highways; it is generally updated every two years.

State Utilities Engineer State representative responsible for management, oversight, and coordination of the state Utilities Accommodation Policy, who works with region representatives, state utility representatives, federal government representatives, and WSDOT executives.

Stormwater Pollution Prevention Plan (SWPP) The proposed efforts to reduce the downstream quality and quantity impacts of stormwater. May include TESC and SPCC plans.

Structural Roadbed See [Roadway Prism](#).

Subsequent Franchise Period That period of time (up to, but not exceeding, 25 years) for which an initial franchise is renewed.

Subsurface Utility Engineering (SUE) To collect, identify, and depict existing underground utility facilities, recognizing the risks at precision levels A through D, with A being the most precise.

Surety Agent The bonding company or banking institution where the surety amount is held in trust.

Surety Duration The period during which a surety is held before release.

Surety Holder The utility owner who has engaged a Surety Agent to hold a surety on the Holder's behalf.

Temporary Erosion and Sediment Control (TESC) Plan A formal plan designed for an individual project for erosion and sediment control.

Toe of Slope See [Slope](#).

Transfer of Ownership The process that transfers ownership of a utility from one entity to another. This process was previously known as Acceptance of Assignment.

Transmittant Of, or relating to, a transmission; the object being transmitted, such as electrical current, gas, water, and so on.

Traveled Way The portion of the roadway intended for the movement of vehicles, exclusive of shoulders and lanes for parking, turning, and storage for turning. The beginning point for measuring the Control Zone, it does not include shoulders, parking lanes, turning lanes, storage for turning lanes, bike lanes, or adjacent pedestrian paths. Generally described as the area between the outer edge stripes (also known as fog lines). (See also [Auxiliary Lane](#).)

Trenched Construction Cutting an open trench for direct placement of a utility. (See also [Open Trench](#).)

Trenchless Construction Installation of an underground utility that does not require the need to use open trench construction methods. Trenchless construction may include, but is not limited to, boring, jacking, auguring, horizontal directional drilling, slip-lining, pipe bursting, or other methods.

Trust Agreement Generally associated with federal agencies such as the Bonneville Power Administration (BPA), U.S. Army Corps of Engineers, and U.S. Forest Service. An agreement that establishes a trust account funded by WSDOT and accessed by the federal agency to pay for ongoing costs associated with the relocation of existing facilities or environmental documentation for a highway improvement project. For use only when the federal agency has property rights or regulatory responsibilities.

Turnback Area New or existing rights of way belonging to WSDOT that are planned to be transferred to a local agency once highway construction is complete. The department maintains utility accommodation approval and oversight authority for these areas prior to completion of the turnback procedure.

UFP Holder Table See [Holder Table](#).

Usable Shoulder See [Shoulder, Usable](#).

Utility A term denoting electric power, communication, cable television, water, gas, oil, petroleum products, steam, chemicals, sewage, drainage, irrigation, fire or police signal systems, and similar lines. Also, the term “utility” includes those utility-type facilities that are owned or leased by a government agency for its own use or otherwise dedicated solely to governmental use. The term utility does not include utility-type facilities required for the support, control, operation, and maintenance of the highway system if they are owned and controlled by the highway authority. The facilities may be privately, publicly, or cooperatively owned.

Utility Accommodation A generic term describing an allowance for a utility installation within the operating highway right of way.

Utility Classification Criteria The four elements of the Utility Classification Criteria are: Highway Number, County, Utility Type, and Utility Owner.

Utility Classification Criteria Consolidation The process by which all existing utility accommodation documents are combined into a single utility Franchise based on the Utility Classification Criteria.

Utility Franchise and Permit (UFP) A database maintained by WSDOT to track existing utility accommodation documents and existing utility facilities located within and abutting highway right of way.

Utility Installation Project Any authorized utility installation within the operating highway right of way.

Utility Maintenance Routine or other work necessary for the continued operation of a utility. Some highways require a preapproved Utility Maintenance Plan.

Utility Mitigation Plan A plan that identifies and provides for mitigation of various utility installations within the operating highway right of way. (See also [Corrective Action Plan](#).)

Utility Object Utility objects are defined for the purpose of these guidelines as utility facilities that exist aboveground and are located within state highway right of way.

Utility Object Relocation Record (UORR) A document that provides the location and identification of aboveground utility objects, their relation in respect to Control Zone requirements, and planned adjustment if needed.

Utility of Record The utility company documented in WSDOT records as the current entity responsible for a specific utility installed within the operating highway right of way.

Utility Reconstruction Replacement work where more than 25% of poles, towers, or other aboveground utilities are replaced within any 1 mile of highway. Does not include individual poles or towers replaced for cause.

Variance Proposal that varies from, or is contrary to, applicable laws, codes, or policies.

Warranty Deed A deed that conveys the title to property whereby the seller guarantees the title to be good and unencumbered, except as stated, and agrees to defend and protect the purchaser against any loss that may arise in the future from any defect in the title at the time of conveyance.

Washington State Department of Transportation (WSDOT) State transportation agency headquartered in Olympia. (See also [Region](#).)

Work Authorization Date Date utility work is authorized to begin.

Zone of Influence The area under and around a structure generally considered to be influenced by the load of that structure.

Appendix B

Utility Forms and Documents

Forms can be accessed through the Forms Catalog (<http://wwwi.wsdot.wa.gov/fasc/adminservices/forms/>) forms are in fillable pdf format)

Or on the WSDOT Electronic Forms page (<http://wsdot.wa.gov/forms/pdfForms.html>)

DOT Form 224-012 EF	Blanket Bond for Franchises and Permits
DOT Form 224-030 EF	Special Provisions for Permits and Franchises, Exhibit A
DOT Form 224-035 EF	City Construction and Maintenance Permit
DOT Form 224-047 EF	Utility Installations to Existing Bridges
DOT Form 224-048 EF	Individual Bond for Franchise or Permit
DOT Form 224-050 EF	Category 4 Installation Authorization (Notice of Compliance)
DOT Form 224-051 EF	Acceptance of Assignment
DOT Form 224-053 EF	Utility Construction Agreement Work by Utility – State Cost
DOT Form 224-062 EF	Utility Construction Agreement Work by State – Utility Cost
DOT Form 224-072 EF	Utility Preliminary Agreement Work by Utility – State Cost
DOT Form 224-071 EF	Utility Construction Agreement Work by State – Shared Cost
DOT Form 224-077 EF	Utility Construction Agreement Work by State – State Cost
DOT Form 224-096 EF	Escrow Agreement Utilities
DOT Form 224-157 EF	Stormwater Permit Special Provision
DOT Form 224-693 EF	Application for Utility Permit (Stormwater Discharge)
DOT Form 224-696 EF	Utility Accommodation Application
DOT Form 224-696 GP EF	Utility Accommodation Application - General Provisions
DOT Form 224-697 EF	Utility Facility Description
DOT Form 224-699 EF	Application for Utility Permit or Franchise for United States Government Agencies
DOT Form 422-004 EF	Inspector’s Daily Report
DOT Form 422-004A EF	Inspector’s Daily Report – Diary Page
DOT Form 422-014	Construction Project Diary

Authority Matrix	B-3
Blanket Crossing Agreement With USBR	B-4
Notice of filing	B-32
Open Cut Crossing Utility Trench Backfill Detail	B-33
Quitclaim Deed (Contact: Real Estate Services Office)	B-34
Utility Object Relocation Record	B-38
Utility Trench Backfill Detail	B-39

Variance Justifications: <http://www.wsdot.wa.gov/Utilities/>

[Control Zone Variance Request Justification](#)

[Limited Access Encroachment Variance Request Justification](#)

[Longitudinal Median Installation Variance Request Justification](#)

[Roadway Prism Open Trench Variance Request Justification](#)

Scenic Classification Variance Request Justification

Shallow Depth Installation Variance Request Justification

Variance Type	Access Type	Approval Authority	FHWA
Longitudinal Utility Installations			
Interstate median		HQ Utilities	Yes
Within full limited access		HQ Utilities	
Within partial or modified limited access highways		Region	
Medians		HQ Utilities	
Uncased Installations			
Involving transmitting material that is flammable, corrosive, expansive, energized, or unstable	Interstate		HQ Utilities
Longitudinal open trench method involving transmitting material that is flammable, corrosive, expansive, energized, or unstable	All others	Region	
Note: Applies to all crossings except those requiring an Access Break			
Access Breaks			
From property adjacent to freeway right of way (temporary)			
Interstate		HQ Access & Hearings	ASDE
Non-Interstate	Full Limited	HQ Access & Hearings	ASDE*
Permanent Breaks on the Interstate require FHWA approval	All others	Region	
Site access from freeway ramps or main line			
Interstate		HQ Access & Hearings	Yes
Non-Interstate	Full Limited	HQ Access & Hearings	ASDE
	All others	Region	
Open Cuts of Pavement			
	Interstate		HQ Utilities
	All others	Region	
Shallow Depth			
	Interstate		HQ Utilities
	All others	Region	
Scenic Class			
Overhead installations, Scenic Classes C & D		Region	
Overhead installations, Scenic Classes AX & BX, with no variances		Region	
Overhead installations scenic Classes A & B			HQ Utilities
Control Zone Location			
Location I Utility Object Variances		Region	
Location II Utility Object Variances		Region	
Location III Utility Objects Aboveground Installations		Region	
Acceptance Assignment for Franchises			
Within a single region		Region	HQ Notification
For which HQ holds a Blanket Surety and the utility is in more than one region			HQ Utilities
Individual Bonds for Permits and Franchises per Utilities Manual, Chapter 1, Section 110.04		Region	
Blanket Bonds for Permits or Franchises			HQ Utilities
General Permits		Region	

* Assistant State Design Engineer

Authority Matrix

BLANKET CROSSING AGREEMENT
with U.S.B.R.
State contract no. GC-1020-B
USBR contract no. 14-06-100-2193
(Administered by UTILITIES ENGINEER)

UNITED STATES
DEPARTMENT OF THE INTERIOR
BUREAU OF RECLAMATION

AGREEMENT WITH STATE OF WASHINGTON
AS TO CROSSINGS

INDEX

<u>Article</u> <u>No.</u>		<u>Page</u> <u>No.</u>
1	Preamble	1
2	Acquisition of Land for Project Works.	1-2
3	Acquisition of Land for State Highways	2
4	Agreement for Mutual Crossing Facilities Necessary	2
5	Surfacing by State of Crossings Constructed by the United States	2-3
6	Definitions.	3-4
7	Rights of Way Granted to the State	4-5
8	Rights of Way Granted to the United States	5
9	Notice of Exercise of Rights of Way.	6-7
10	Cost of Crossings Initiated by State	7-8
11	Cost of Crossings Initiated by the United States	8-10
12	Constructing Crossings by the United States.	10-12
13	Constructing Crossings by the State.	12-13
14	Abandonment of State Structures.	13
15	Abandonment of United States Structures.	13-14
16	Title to and Maintenance of Crossing Facilities.	14-15
17	United States Does Not Assume Liability.	16
18	State Does Not Assume Liability.	16
19	Right to Enter on Other's Right of Way	16-17
20	Revocations.	17
21	Conditions of Labor.	18-20
22	Contingent on Appropriations	20
23	Discrimination Against Employees or Applicants for Employment Prohibited	20-23
24	Domestic Preferences	23-24
25	Officials Not to Benefit	24
26	Covenant Against Contingent Fees	24-25

Contract No.
14-06-100-2193

UNITED STATES
DEPARTMENT OF THE INTERIOR
BUREAU OF RECLAMATION

AGREEMENT WITH STATE OF WASHINGTON
AS TO CROSSINGS

THIS CONTRACT, made this 14th day of June, 1961, pursuant to the Act of June 17, 1902 (32 Stat. 388) and all acts amendatory thereof or supplementary thereto, including without limitation by this enumeration the Act of August 4, 1939 (53 Stat. 1187), as amended, referred to hereinafter as the Federal Reclamation Laws, by and between THE UNITED STATES OF AMERICA (hereinafter styled the United States), acting solely through the Bureau of Reclamation and represented by the officer executing this contract, and the STATE OF WASHINGTON (hereinafter styled the State), a body politic and corporate, acting by and through its Governor, its Director of Highways (the latter being hereinafter styled the Director), and its State Highway Commission,

WITNESSETH, THAT:

2. WHEREAS, the United States is and will be engaged in the construction, reconstruction, operation and maintenance, under the Federal Reclamation Laws, within the State of Washington, of irrigation, drainage, water delivery, and reclamation projects (hereinafter called projects), and the works of the projects include and will include networks

of waterways and water conduits, telephone, telegraph, and electric transmission lines, and other irrigation and power works, for which the United States has acquired or will acquire lands in fee simple or rights of way of various kinds, or for which it claims rights of way under Section 90.40.050, Revised Code of Washington, the Act of Congress of August 30, 1890 (26 Stat. 391), or other acts of Congress; and

3. WHEREAS, the State now has a network of highways adjacent to and within the projects' areas and may from time to time relocate or add to these highways, and for these highways it now owns, or may hereafter acquire, lands in fee simple or rights of way of various kinds; and

4. WHEREAS, the activities of each party in and adjacent to the projects' areas will require the construction, reconstruction, modification, and operation and maintenance of mutual crossing facilities and the parties wish to avoid the burden and expense of negotiating separate contracts or arranging for and issuing franchises or permits, and to confirm by contract the understandings heretofore had with respect to crossing highway works designated or established by the State as limited access facilities; and

5. WHEREAS, the State, in most instances, desires to place on its roads the upper surfacing courses and the wearing surface whenever those are necessary in connection with the crossing of its highways by facilities of the United States under this contract, and it has been mutually

determined to be in the best interests of both parties to have the State perform such work:

NOW THEREFORE, in consideration of the grants and agreements herein contained, the parties hereto grant and agree as follows:

DEFINITIONS

6. The following terms, wherever used in this contract, shall have the following respective meanings:

"Waterway works" shall mean any canal, ditch, lateral, sublateral, drain, spillway, wasteway, siphon, pipeline, or other waterway or water conduit, and any road required in connection with the construction or operation of such works, built or to be built as part of the projects works.

"Transmission line" shall mean any telephone, telegraph, or electric transmission line or other power works, and any road required in connection with the construction or operation of such works, built or to be built as part of the projects' works.

"Project waterway" shall mean any land owned in fee or any right of way, excluding "reserved ways", designated by the United States as the site for any waterway works.

"Transmission way" shall mean any land owned in fee or any right of way, excluding "reserved ways", designated by the United States as the site for any transmission line.

"Reserved way" shall mean any right of way reserved to the United States under Section 90.40.050, Revised Code of Washington, the Act of August 30, 1890 (26 Stat. 391), or other acts of Congress, and which has been or is to be designated for use in the construction, operation and maintenance of project works as permitted by law.

"Highway works" shall mean any highway and appurtenant works built or to be built in connection with the highway system of the State.

"Highway" shall mean any land owned in fee or any right of way designated by the State as the site for its highway works.

"Project Officer" shall mean that employee of the United States in charge of a Bureau of Reclamation project in which is located a crossing to be handled pursuant to the provisions of this agreement.

"Regional Director" shall mean the Regional Director, Region 1, Bureau of Reclamation, or his duly authorized representative.

RIGHTS OF WAY GRANTED TO THE STATE

7. The United States hereby grants to the State, subject to the provisions of this contract, perpetual rights to construct, reconstruct, modify, operate and maintain highway works upon or across any project waterway, transmission way, and reserved way. The rights in each instance shall be effective from the date of the approval of the State's application made under the provisions of Article 9 hereof or provisions

similar thereto in contracts referred to in Article 20 hereof. In any instance where the grant herein made is with respect to land in which the United States has only a right of way or easement, the State will obtain any additional grants or consents from the owners of such other interests in the land as may be necessary to permit full use of the land by the State for its purposes.

RIGHTS OF WAY GRANTED TO THE UNITED STATES

8. The State hereby grants to the United States, subject to the provisions of this contract, perpetual rights to construct, reconstruct, modify, operate and maintain waterway works and transmission lines upon or across any highway, and hereby ratifies and confirms the reservation under and by virtue of the Act of August 30, 1890 (26 Stat. 391), or other acts of Congress, and Section 90.40.050, Revised Code of Washington, of the reserved way across, along, or under any highway on land subject to such reserved way. The rights in each instance shall be effective from the date of the approval of the application of the United States made under the provisions of Article 9 hereof or provisions similar thereto in contracts referred to in Article 20 hereof or from the date of any highway use franchise or permit issued by the State. In any instance where the grant herein made is with respect to land in which the State has only a right of way or easement, the United States will obtain any additional grants or consents from the owners of such interest in the land as may be necessary to permit full use of the land by the United States for its purposes.

NOTICE OF EXERCISE OF RIGHTS OF WAY

9. The party desiring to exercise the rights granted under Articles 7 and 8 shall notify the other party in writing prior to the beginning of construction. Such notice shall be given immediately before the rights are to be utilized by the construction of a crossing, and, in the case of the United States, the notice shall be given to the Project Officer, if any, otherwise the Regional Director, and, in the case of the State, to the Director. The notice shall be accompanied by a location map showing the proposed crossing and by plans for the facilities proposed to be constructed. The party receiving the notice shall promptly initiate action, including insofar as the United States is concerned consultation with the irrigation district, if any, operating its waterway works and transmission lines, on approval or disapproval of the proposed crossing, indicating in the latter instance the reasons therefor. The State will not refuse approval of reasonable plans submitted by the United States if such plans provide for a class of construction equal or superior to the standard of construction used by the State itself for similar purposes; and the United States will not refuse approval of reasonable plans submitted by the State, if such plans provide for a class of construction equal or superior to the standard of construction used by the United States for similar purposes. Approval of the plans shall be made by the execution and dating of the location map; approval of the

United States shall be given by the Regional Director; and approval of the State shall be given by the Director.

COST OF CROSSINGS INITIATED BY STATE

10. (a) Where the State's exercise of the rights granted under Article 7 has been approved under the provisions of Article 9 hereof, and at the time of that approval, waterway works or transmission lines at the point of crossings are in existence, or are being built by Government forces or are under contract to be built for the United States, the State shall, at its sole expense, construct and install whatever facilities are required and do whatever work is necessary to effect the crossing in accordance with the plans approved under Article 9 hereof. The words "are being built by Government forces", as used herein, shall not be construed to mean that which is confined solely to the clearing of rights of way and/or the building of haul or pioneer roads.

(b) Where the State's exercise of the rights granted under Article 7 has been approved under the provisions of Article 9 hereof, and at the time of that approval no waterway works or transmission lines are in existence at the point of crossing or are being built or are under contract to be built, the State, when building its highway works at the place of crossing, will (1) provide, at the request of the United States, if the latter has funds available to pay therefor, facilities necessary to accommodate the waterway works or transmission lines to be built later by the United States; or (2) construct, at the

request of the United States, if practicable, its highway works in a manner that will enable the United States, within a reasonable time after the completion thereof, to construct the facilities necessary to accommodate its waterway works or transmission lines without added undue expense or inconvenience on account thereof. The added cost to the State of providing facilities under (1) and (2) of this subarticle will be borne by the United States. In determining these costs, there shall be included all costs of materials and labor directly chargeable to the facilities as approved under subarticle (c) hereof, and in addition an amount equal to ten per cent (10%) of said costs to cover supervision, engineering, inspection, and general overhead. Promptly on the completion of the facilities in any case under (1) and (2) of this subarticle, the State shall submit to the United States an itemized bill of the added cost required to be paid by the United States hereunder. Payment of such cost shall be made promptly after the presentation of such bill.

(c) Whatever facilities are required to be constructed by the State for the United States under this article shall be constructed in accordance with plans and specifications therefor approved by the Regional Director.

COST OF CROSSINGS INITIATED BY UNITED STATES

11. (a) Where the United States' exercise of the rights granted under Article 8 has been approved under the provisions of Article 9 hereof, and at the time of that approval highway works are

in existence or are being built by State forces or are under contract to be built for the State, the United States shall, at its sole expense, construct and install whatever facilities are required and do whatever work is necessary to effect the crossing in accordance with the plans approved under Article 9 hereof. The words "are being built by State forces", as used herein, shall not be construed to mean that which is confined solely to the clearing of rights of way and/or the building of haul or pioneer roads.

(b) Where the United States' exercise of the rights granted under Article 8 has been approved under the provisions of Article 9 hereof, and at the time of that approval no highway works are in existence at the place of crossing or are being built or under contract to be built, the United States, when building its waterway works or transmission lines at the place of crossing, will (1) provide, at the request of the State, if the latter has funds available to pay therefor, facilities necessary to accommodate the highway works to be built later by the State; or (2) construct, at the request of the State, if practicable, its waterway works or transmission lines in a manner that will enable the State, within a reasonable time after the completion thereof, to construct the facilities necessary to accommodate its highway works without added undue expense or inconvenience on account thereof. The added cost to the United States of providing facilities under (1) and (2) of this subarticle will be borne by the State. In determining these costs, there shall

be included all costs of materials and labor directly chargeable to the facilities as approved under Subarticle (c) hereof, and in addition an amount equal to ten per cent (10%) of said costs to cover supervision, engineering, inspection, and general overhead. Promptly on the completion of the facilities in any case under (1) and (2) of this subarticle, the United States shall submit to the State an itemized bill of the added cost required to be paid by the State hereunder. Payment of such cost shall be made promptly after the presentation of such bill.

(c) Whatever facilities are required to be constructed by the United States for the State under this article shall be constructed in accordance with plans and specifications therefor approved by the Director.

CONSTRUCTING CROSSINGS BY UNITED STATES

12. (a) The United States, in performing work pursuant to a grant under the provisions of Article 8 of this contract, shall observe the following conditions:

(1) Such work shall be conducted in a proper and workmanlike manner;

(2) Such work shall be conducted so that the highway works will be closed to traffic for as brief a period as possible.

Upon request of the State, a suitable detour shall be constructed, at the sole cost and expense of the United States, around or over such construction so that traffic may pass freely at all times,

and such detour shall be maintained by the United States at its sole cost and expense; and

(3) The material removed from the highway shall be replaced or renewed so that, upon completion of the crossing, the highway and highway works will be in as good condition as they were prior to such work by the United States.

(b) With respect to highway surfacing work which the State desires to perform in connection with the crossing of its highways by facilities of the United States, the State will notify the Project Officer, prior to beginning such work, of its desire to perform the surfacing work. The notice shall specify the work that the State proposes to perform and shall include an itemized estimate of the cost thereof. The Project Officer shall promptly forward the notice with his recommendation to the Regional Director for approval or disapproval of the proposed work in connection with the crossing and the cost estimate therefor. The Regional Director shall indicate in case of disapproval the reasons therefor, and shall notify the representative of the State giving the notice. Upon approval of the work and estimate in behalf of the United States, the State shall furnish, lay, and finish the upper surfacing courses and the wearing surface required in connection with the crossing of its highways by facilities of the United States and shall perform all necessary work in connection therewith. The State, upon completion of the surfacing work, will submit to the United States a record of the actual costs and

expenditures incurred by the State, supported by such information as may be required by the United States, and officers of the United States shall be permitted to check the work records pertaining to any such work and all other books, accounts and records of the State to determine the correctness of the statement. Payment by the United States to the State of the portion of the cost for which the United States is liable under the terms of this subarticle, not to exceed the estimated amount approved in behalf of the United States as hereinbefore provided, shall be made after verification and approval of the cost statement by the Regional Director.

CONSTRUCTING CROSSINGS BY THE STATE

13. The State, in performing work pursuant to a grant under the provisions of Article 7 of this contract, shall observe the following conditions:

(a) Such work shall be conducted in a proper and workmanlike manner.

(b) The State shall not in any case or circumstance stop, impede, or interfere with the flow of water in any waterway works, and in the event that the State performs such work during an irrigation season, which for the purpose of this contract shall ordinarily be considered to be from the 15th day of March to the 15th day of October of each year, or while the waterway works are being used for the generation of electric power, or such work is carried into an irrigation season, the State shall provide such temporary ditch,

siphon, or other structure as may be necessary and as directed and as approved by the Project Officer, to assure the continued flow of water in the waterway works along the regular course thereof without waste or loss.

(c) The material removed from the project waterway shall be replaced or renewed so that, upon completion of the work, the project waterway and waterway works will be in as good condition as they were prior to the work by the State.

ABANDONMENT OF STATE STRUCTURES

14. In the event the State abandons any of its highway works over a project waterway, the State shall, at its sole cost and expense, remove the structure or structures constructed by or for it and restore the project waterway to its condition prior to the construction of such structure or structures by or for the State, or do whatever is required by the United States to leave the project waterway in a condition satisfactory to the United States: Provided, however, That any highway works abandoned by the State and turned over to a county or municipality shall be exempt from the provisions of this article, and the United States will deal directly with the county or municipality with respect to such highway works.

ABANDONMENT OF UNITED STATES STRUCTURES

15. In the event the United States abandons any of its waterway works or transmission lines upon or across any highway, the United

States shall, at its sole cost and expense, remove the structure or structures constructed by or for it and restore the highway to its condition prior to the construction of such structure or structures by or for the United States, or do whatever is required by the State to leave the highway in a condition satisfactory to the State.

TITLE TO AND MAINTENANCE OF CROSSING FACILITIES

16. (a) Promptly upon the completion of any facilities constructed under the terms of this contract, the party doing the construction shall give written notice to the other party announcing the completion of the facilities and indicating, according to the nature and purpose thereof, which portion or portions of the facilities, hereinafter referred to as structures, shall be deemed to comprise a part of the highway works and which portion or portions shall be deemed a part of the waterway works or transmission lines. The party receiving the notice shall indicate promptly its acceptance of title as set out in the notice or its objections thereto. Such notices shall be issued and accepted on behalf of the United States by the Regional Director, and on behalf of the State by the Director.

(b) The United States and the State shall replace their respective structures at their own expense with new structures approved by the other party from time to time as the necessity arises, and make such repairs as may be necessary to protect waterway works, transmission

lines, or highway works from damage or interference from said structures. It shall be the duty of the United States and of the State in this regard to maintain their respective structures in such a manner as to be deemed safe and in repair, consistent with customary management practices.

(c) All work done by the United States or the State in maintaining or replacing their respective structures shall be done in a good workmanlike manner.

(d) In the event the United States or the State shall fail, refuse, or neglect to maintain their respective structures as in this article provided, the other party may, after thirty (30) days' written notice, replace, reconstruct, repair, or change any of said structures, forming a part of the waterway works, transmission lines, or highway works, in such manner as it shall determine: Provided, however, That in the event of an emergency, one party may, with the written assent of the owning or responsible party, perform necessary maintenance work at the expense of the party who has the obligation to pay therefor; and the party whose structures have been replaced, reconstructed, repaired, or changed shall reimburse the other party for the entire cost and expense thereof within ninety (90) days after submission of a written statement or statements showing in detail the items of expense included in the cost of the same. The party who has to pay the cost may, at its sole cost and expense, make whatever audits are necessary to verify the correctness of such statement or statements.

UNITED STATES DOES NOT ASSUME LIABILITY

17. The United States does not, by reason of this contract, or by reason of any grants made pursuant to Article 7 of this contract, assume any liability for injury or damage to any person or property incident to or arising during and in consequence of (a) the use, occupancy, and enjoyment by the State, pursuant to this contract, of any project waterway, transmission way, or reserved way; or (b) the operation and maintenance of any highway works across any project waterway, transmission way, or reserved way, pursuant to grant under Article 7 of this contract.

STATE DOES NOT ASSUME LIABILITY

18. The State does not, by reason of this contract, or by reason of any grants made pursuant to Article 8 of this contract, assume any liability for injury or damage to any person or property incident to or arising during and in consequence of (a) the use, occupancy, and enjoyment by the United States, pursuant to this contract, of any highway; or (b) the operation and maintenance of any waterway works or transmission lines across any highway pursuant to grant under Article 8 of this contract.

RIGHT TO ENTER ON OTHER'S RIGHT OF WAY

19. The United States and the State, and their respective officers, agents, contractors and employees, shall at any and all times have the right to enter upon the rights of way of the other, granted

as provided herein, for the purpose of doing anything necessary in connection with the construction, replacing, repairing, operation or maintenance of any portion or part of their respective waterway works, transmission lines, or highway works, including all structures and crossings which may be built in pursuance of the provisions of this contract, except that, as regards the State limited access highways or State highways which may, by proper act of State Legislature or by resolution of the Washington State Highway Commission, become limited access highways, the United States and its respective officers, agents, contractors and employees, shall have the right to enter upon the right of way of the State only in accordance with the plan for ingress and egress designed for such limited access highways, which plan shall include reasonable provisions to meet the needs of the United States and its operating districts in connection with the operation and maintenance of its projects.

REVOCATIONS

20. The following agreements with respect to crossings between the State and the United States and all supplements thereto are revoked and superseded by this contract:

1. Contract No. I74r-856, dated November 9, 1948, covering highway crossings in the Columbia Basin Project, Washington;

2. Contract No. I74r-1480, dated March 25, 1950, covering highway crossings in the Roza Division of the Yakima Project, Washington.

3. Contract No. 14-06-100-45, dated December 4, 1952, covering highway surfacing at waterway crossings, in the Columbia Basin Project, Washington; and

4. Contract No. 14-06-100-355, dated January 2, 1954, covering highway crossings in the Kennewick Division of the Yakima Project, Washington.

Provided, however, That any rights, privileges or grants by and between the parties thereto pursuant to the documents revoked and superseded by this article or pursuant to various franchises or permits issued to or in favor of the United States, and which are effective or in force on the date of this contract shall continue in force and effect on terms and conditions as if made under this contract.

CONDITIONS OF LABOR

21. (a) No laborer or mechanic doing any part of the work contemplated by Subarticle 10(b) of this contract on structures constituting a part of the waterway works or transmission lines of the United States, in the employ of the contractor or any subcontractor contracting for any part of said work contemplated, shall be required or

permitted to work more than eight (8) hours in any one (1) calendar day upon such work at the site thereof, except upon the condition that compensation is paid to such laborer or mechanic in accordance with the provisions of this article. The wages of every laborer and mechanic employed by the contractor or any subcontractor engaged in the performance of this contract shall be computed on a basic day rate of eight (8) hours per day, and work in excess of eight (8) hours per day is permitted only upon the condition that every such laborer or mechanic shall be compensated for all hours worked in excess of eight (8) hours per day at not less than one and one-half (1½) times the basic rate of pay. For each violation of the requirements of this article, a penalty of five dollars (\$5) shall be imposed upon the contractor for each laborer or mechanic for every calendar day in which such employee is required or permitted to labor more than eight (8) hours upon said work without receiving compensation computed in accordance with this article, and all penalties thus imposed shall be withheld for the use and benefit of the Government: Provided, That this stipulation shall be subject in all respects to the exceptions and provisions of UNITED STATES CODE, Title 40, Sections 321, 324, 325, 325a, and 326, relating to hours of labor and compensation for overtime.

(b) All contracts awarded by the State covering work under Sub-article 10(b) of this contract on structures constituting a part of the waterway works or transmission lines of the United States shall

contain the following provision, to wit: The contractor shall not employ any person undergoing sentence of imprisonment at hard labor.

CONTINGENT ON APPROPRIATIONS

22. The expenditure of any money or the performance of any work by the United States or the State, herein provided for, which may require appropriations of money by Congress or the Legislature or the allotment of Federal funds, shall be contingent on such appropriations or allotments being made. The failure of Congress or the Legislature to appropriate funds, or the failure of any allotment of funds, shall not, however, relieve the State or the United States from any obligation theretofore accrued under this agreement, nor give the State or the United States the right to terminate this agreement as to any of its executory features. No liability shall accrue against the United States or the State in case such funds are not so appropriated or allotted.

DISCRIMINATION AGAINST EMPLOYEES OR
APPLICANTS FOR EMPLOYMENT PROHIBITED

23. In connection with the performance of work under this contract on structures constituting a part of the waterway works or transmission lines of the United States, the State, referred to hereinafter in this article as the contractor, agrees as follows:

(a) The contractor will not discriminate against any employee or applicant for employment because of race, creed, color, or national origin. The contractor will take affirmative action to ensure that

applicants are employed, and that employees are treated during employment, without regard to their race, creed, color, or national origin. Such action shall include, but not be limited to, the following: employment, upgrading, demotion or transfer; recruitment or recruitment advertising; layoff or termination; rates of pay or other forms of compensation; and selection for training, including apprenticeship. The contractor agrees to post in conspicuous places, available to employees and applicants for employment, notices to be provided by the contracting officer setting forth the provisions of this nondiscrimination clause.

(b) The contractor will, in all solicitations or advertisements for employees placed by or on behalf of the contractor, state that all qualified applicants will receive consideration for employment without regard to race, creed, color, or national origin.

(c) The contractor will send to each labor union or representative of workers with which he has a collective bargaining agreement or other contract or understanding, a notice, to be provided by the agency contracting officer, advising the said labor union or workers' representative of the contractor's commitments under this section, and shall post copies of the notice in conspicuous places available to employees and applicants for employment.

(d) The contractor will comply with all provisions of Executive Order No. 10925 of March 6, 1961, and of the rules, regulations, and

relevant orders of the President's Committee on Equal Employment Opportunity created thereby.

(e) The contractor will furnish all information and reports required by Executive Order No. 10925 of March 6, 1961, and by the rules, regulations, and orders of the said Committee, or pursuant thereto, and will permit access to his books, records, and accounts by the contracting agency and the Committee for purposes of investigation to ascertain compliance with such rules, regulations, and orders.

(f) In the event of the contractor's noncompliance with the nondiscrimination clause of this contract or with any of the said rules, regulations, or orders, this contract may be cancelled in whole or in part and the contractor may be declared ineligible for further government contracts in accordance with procedures authorized in Executive Order No. 10925 of March 6, 1961, and such other sanctions may be imposed and remedies invoked as provided in the said Executive Order or by rule, regulation, or order of the President's Committee on Equal Employment Opportunity, or as otherwise provided by law.

(g) The contractor will include the provisions of the foregoing paragraphs (a) through (f) in every subcontract or purchase order unless exempted by rules, regulations, or orders of the President's Committee on Equal Employment Opportunity issued pursuant to Section

303 of Executive Order No. 10925 of March 6, 1961, so that such provisions will be binding upon each subcontractor or vendor. The contractor will take such action with respect to any subcontract or purchase order as the contracting agency may direct as a means of enforcing such provisions, including sanctions for noncompliance: Provided, however, That in the event the contractor becomes involved in, or is threatened with, litigation with a subcontractor or vendor as a result of such direction by the contracting agency, the contractor may request the United States to enter into such litigation to protect the interests of the United States, with the understanding that, in the event of noncompliance with the above provisions, this contract may only be cancelled under (f) thereof insofar as it relates to the State's doing work on structures constituting a part of the waterway works and transmission lines of the United States under this contract.

DOMESTIC PREFERENCES

24. In the performance of the work covered by Subarticle 10(b) of this contract on any facility constituting a part of the waterway works or transmission lines of the United States, the State, subcontractors, material men, or suppliers, shall use only such unmanufactured articles, materials, and supplies as have been mined or produced in the United States, and only such manufactured articles, materials, and supplies as have been manufactured in the United States substantially all from articles, materials, or supplies mined, produced, or manufactured,

as the case may be, in the United States. The foregoing provision shall not apply to such articles, materials, or supplies of the class or kind to be used, or such articles, materials, or supplies from which they are manufactured, as are not mined, produced, or manufactured, as the case may be, in the United States in sufficient and reasonably available commercial quantities and of a satisfactory quality, or to such articles, materials, or supplies as may be excepted by the head of the Department under the proviso of Title III, Section 3, of the Act of March 3, 1933, 47 Stat. 1520 (UNITED STATES CODE, Title 41, Section 10b).

OFFICIALS NOT TO BENEFIT

25. No Member of or Delegate to Congress, or Resident Commissioner shall be admitted to any share or part of this contract or to any benefit that may arise herefrom, but this restriction shall not be construed to extend to this contract if made with a corporation or company for its general benefit.

COVENANT AGAINST CONTINGENT FEES

26. The State warrants that no person or agency has been employed or retained to solicit or secure this instrument upon an agreement or understanding for a commission, percentage, brokerage, or contingent fee, excepting bona fide employees or bona fide established commercial agencies maintained by the State for the purpose of securing business. For breach or violation of this warranty, the

United States shall have the right to annul this instrument without liability or in its discretion to require the State to pay the full amount of such omission, percentage, brokerage, or contingent fee.

IN WITNESS WHEREOF, the parties hereto have signed their names the day and year first above written.

THE UNITED STATES OF AMERICA

By: /s/ M. B. Austin
Acting Regional Director
(Title)

STATE OF WASHINGTON

By: /s/ Albert D. Rosellini
Governor

/s/ W. A. Bugge
State Director of Highways

/s/ Ernest J. Ketcham
Washington State Highway Commission Chairman

(SEAL)

Attest:

/s/ Lorenz Goetz
Secretary

APPROVED:

/s/ John C. O'Rourke
State Attorney General

STATE OF IDAHO)
 : ss
County of Ada)

On this 14th day of June, 1961, personally

appeared before me M. B. Austin, to me known to be the official of the United States of America that executed the within and foregoing instrument and acknowledged said instrument to be the free and voluntary act and deed of said United States, for the uses and purposes therein mentioned, and on oath stated that he was authorized to execute said instrument.

IN WITNESS WHEREOF, I have hereunto set my hand and affixed my official seal the day and year first above written.

/s/ John H. Welch
Notary Public in and for the
State of Idaho
Residing at Boise

(SEAL) My commission expires: 6-10-63

- - - -

STATE OF WASHINGTON)
 : ss
County of Thurston)

On this 31st day of May, 1961, personally

appeared before me Albert D. Rosellini, to me known to be the Governor of the State of Washington that executed the within and foregoing instrument and acknowledged said instrument to be the free and voluntary act and deed of said State of Washington, for the uses and purposes therein mentioned, and on oath stated that he was authorized to execute said instrument.

IN WITNESS WHEREOF, I have hereunto set my hand and affixed my official seal the day and year first above written.

/s/ V. B. Otis
Notary Public in and for the
State of Washington
Residing at Olympia

(SEAL) My commission expires: Mch. 9, 1962

STATE OF WASHINGTON)
: ss
County of Thurston)

On this 24th day of May, 1961, personally
appeared before me Ernest J. Ketchan and

W. A. Bugge to me known to be the Chairman
of the Washington State Highway Commission and the Director of High-
ways of the State of Washington, respectively, that executed the
within and foregoing instrument and acknowledged said instrument to
be the free and voluntary act and deed of said State of Washington,
for the uses and purposes therein mentioned, and on oath stated
that they were authorized to execute said instrument.

IN WITNESS WHEREOF, I have hereunto set my hand and affixed
my official seal the day and year first above written.

/s/ V. B. Otis
Notary Public in and for the
State of Washington
Residing at Olympia

(SEAL)

My commission expires: March 9th, 1962

NOTICE OF FILING

Franchise Application No. _____

(Utility's name), a (private corporation, municipality, etc.), has filed with the Washington State Department of Transportation, under the provisions of Chapter 47.44 RCW and amendments thereto, an application for a franchise to construct, operate, and maintain (short description of facilities) upon a portion of State Route No. _____, in (county in which facilities are located) County, Washington, at the following locations:

(Legal description showing beginning milepost and legal description) thence northerly (easterly, etc.) to a point opposite approximate (ending milepost and legal description).

NOTICE IS HEREBY GIVEN that this franchise application may be granted by the Secretary of Transportation or his/her designee, with or without hearing, in the absence of receipt by the department of any written inquiries or objections within 14 days after posting and publishing of this notice.

DATED at (region office location), Washington, this _____ day of (Month), 20____.

Regional Administrator

Notice of Filing

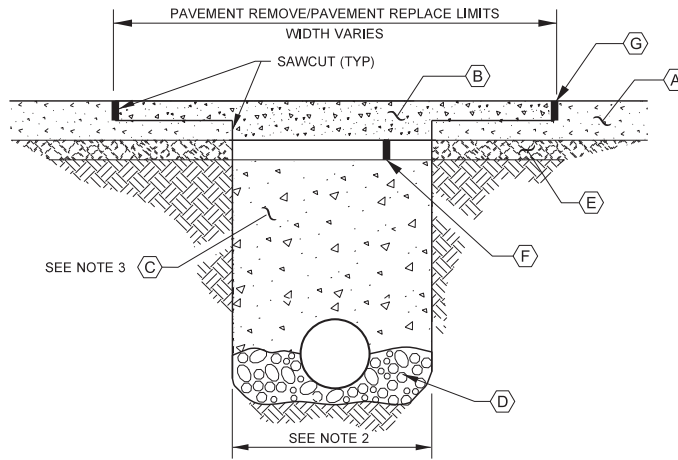

OPEN CUT CROSS SECTION
NTS

LEGEND

- (A) EXISTING HMA (HOT MIX ASPHALT) OR PCCP (PORTLAND CEMENT CONCRETE PAVEMENT).
- (B) HMA CLASS 1/2 INCH OR PCCP; DEPTH AND MATERIAL SHALL MATCH EXISTING PAVEMENT. REMOVAL AND REPLACE-
MENT LIMITS OF PAVEMENT TO BE DETERMINED AT THE TIME OF UTILITY PERMIT/FRANCHISE REVIEW.
- (C) APPROVED BACKFILL MATERIAL OR CDF (CONTROL DENSITY BACKFILL) OR AS SPECIFIED BY WSDOT.
- (D) BEDDING MATERIAL DEPTH BENEATH PIPE / CASING SHALL BE SIX (6) INCHES. ADDITIONAL PIPE BEDDING
SHALL BE PLACED EQUAL TO HALF THE DIAMETER OF PIPE / CASING OR SIX (6) INCHES WHICHEVER IS LESS.
- (E) EXISTING CRUSHED SURFACING BASE COURSE.
- (F) CRUSHED SURFACING BASE COURSE DEPTH SHALL MATCH DEPTH OF EXISTING CRUSHED
SURFACING BASE COURSE.
- (G) HMA BUTT JOINT REQUIRES TACK, SEAL AND SAND. FOR PCCP REFER TO GENERAL NOTE 5.

GENERAL NOTES

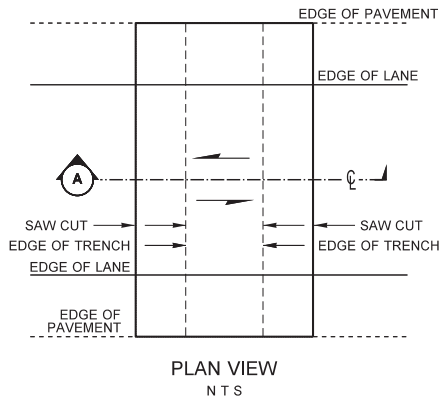

PLAN VIEW
NTS

1. TRENCHING AND PIPE INSTALLATION SHALL MEET THE REQUIREMENTS OF WSDOT STANDARD SPECIFICATION 7-08.
2. MAXIMUM TRENCH WIDTH SHALL NOT EXCEED CASING / PIPE DIAMETER PLUS AN ADDITIONAL ONE (1) FOOT ON EITHER SIDE OF THE CASING / PIPE.
3. COMPACTION SHALL BE METHOD C PER STANDARD SPEC. SECTION 2-03.3 (14)C.
4. MINIMUM DEPTH SHALL BE SIXTY (60) INCHES FROM THE FINISHED SURFACE TO TOP OF CASING/ PIPE.
5. PCCP SHALL BE REPLACED TO THE NEXT PANEL JOINT IN EACH DIRECTION AS APPROVED BY WSDOT. ALL WORK SHALL BE AS SPECIFIED IN WSDOT STANDARD SPECIFICATION SECTION 5-01.3(4).
6. WHEN CONNECTING TO AN EXISTING FACILITY UNDER THE PAVEMENT, PAVEMENT RESTORATION MAY, AT THE DEPARTMENT'S DISCRETION, INCLUDE THE FULL LANE WIDTH AND ENCROACHED SHOULDER.
7. CASING PIPES SHALL EXTEND A MINIMUM OF SIX (6) FEET BEYOND THE TOE OF FILL SLOPES, BOTTOM OF DITCHLINE, OR OUTSIDE OF CURB.
8. TACK ASPHALT PER WSDOT STANDARD SPECIFICATION 5-4.3(5)A.

APPLICATION:	OPEN CUT CROSSING UTILITY TRENCH BACKFILL DETAIL	 Washington State Department of Transportation WSDOT Utility Accommodation	
APPROVALS:			
REVISID: March 2012			DATE:

Open Cut Crossing Utility Trench Backfill Detail

After recording return document to:

State of Washington
Department of Transportation
Real Estate Services Office
P O Box 47338
Olympia WA 98504-7338

Document Title: Quitclaim Deed
Reference Number of Related Document: { }
Grantor(s): { }
Grantee(s): State of Washington, Department of Transportation
Legal Description: { }
Additional Legal Description is on Page(s) { } of Document.
Assessor's Tax Parcel Number(s): { }

QUITCLAIM DEED

State Route { }

The Grantor, { utility company name }, { type of entity }, for and in consideration of TERMS SET FORTH IN UTILITY AGREEMENT NO. UT _____, hereby conveys and quitclaims to the **State of Washington, Department of Transportation**, the following described real property, and any after acquired interest therein, situated in { } County, State of Washington, under the imminent threat of the Grantee's exercise of its right of Eminent Domain:

For legal description and additional conditions,
see Exhibit A attached hereto and made a part hereof.

It is understood and agreed that delivery of this deed is hereby tendered and that the terms and obligations hereof shall not become binding upon the State of Washington

RES-306
Revised 09/05

Page { page } of { numpages } pages

FA No. F-{ } ()
Project No. { }
Parcel No. { }

After recording return document to:

State of Washington
 Department of Transportation
 Real Estate Services Office
 P O Box 47338
 Olympia WA 98504-7338

Document Title: Quitclaim Deed

Reference Number of Related Document: { }

Grantor(s): { }

Grantee(s): State of Washington, Department of Transportation

Legal Description: { }

Additional Legal Description is on Page(s) { } of Document.

Assessor's Tax Parcel Number(s): { }

QUITCLAIM DEED

State Route { }

The Grantor, { utility company name }, { type of entity }, for and in consideration of TERMS SET FORTH IN UTILITY AGREEMENT NO. UT _____, hereby conveys and quitclaims to the **State of Washington, Department of Transportation**, the following described real property, and any after acquired interest therein, situated in { } County, State of Washington, under the imminent threat of the Grantee's exercise of its right of Eminent Domain:

For legal description and additional conditions,
 see Exhibit A attached hereto and made a part hereof.

It is understood and agreed that delivery of this deed is hereby tendered and that the terms and obligations hereof shall not become binding upon the State of Washington

RES-306
 Revised 09/05

Page { page } of { numpages } pages

FA No. F-{ } ()
 Project No. { }
 Parcel No. { }

QUITCLAIM DEED

unless and until accepted and approved hereon in writing for the State of Washington,
Department of Transportation, by the Director of Real Estate Services.

Date: _____, {year}

{ utility company }

By: _____
{ officer }

Its: _____
{ name }

By: _____
{ officer }

Its: _____
{ name }

Accepted and Approved

STATE OF WASHINGTON,
Department of Transportation

By: _____
Gerald L. Gallinger
Director, Real Estate Services

Date: _____

RES-306

Page { page } of { numpages } pages Parcel No. { }

After recording return document to:

State of Washington
Department of Transportation
Real Estate Services Office
P O Box 47338
Olympia WA 98504-7338

Document Title: Quitclaim Deed
Reference Number of Related Document: { }
Grantor(s): { }
Grantee(s): State of Washington, Department of Transportation
Legal Description: { }
Additional Legal Description is on Page(s) { } of Document.
Assessor's Tax Parcel Number(s): { }

QUITCLAIM DEED

State Route { }

The Grantor, { utility company name }, { type of entity }, for and in consideration of TERMS SET FORTH IN UTILITY AGREEMENT NO. UT _____, hereby conveys and quitclaims to the **State of Washington, Department of Transportation**, the following described real property, and any after acquired interest therein, situated in { } County, State of Washington, under the imminent threat of the Grantee's exercise of its right of Eminent Domain:

For legal description and additional conditions,
see Exhibit A attached hereto and made a part hereof.

It is understood and agreed that delivery of this deed is hereby tendered and that the terms and obligations hereof shall not become binding upon the State of Washington

RES-306
Revised 09/05

Page { page } of { numpages } pages

FA No. F-{ } ()
Project No. { }
Parcel No. { }

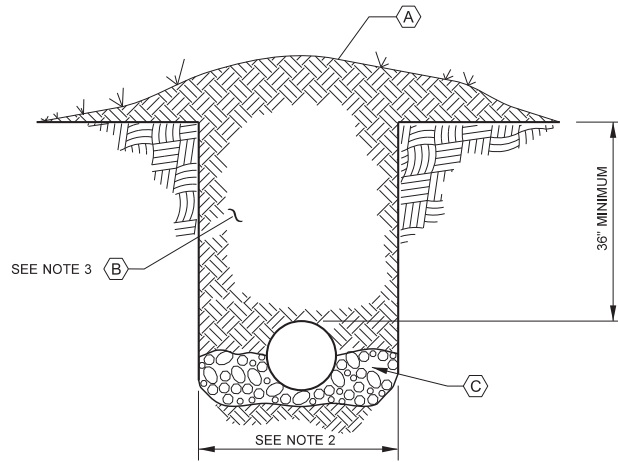

TRENCH CROSS SECTION
NTS

LEGEND

- (A) SURFACE RESTORATION WILL MATCH EXISTING ADJACENT TREATMENT (SEEDING, BARK, ETC.)
- (B) NATIVE MATERIAL OR AS DIRECTED BY WSDOT.
- (C) BEDDING MATERIAL DEPTH BENEATH THE PIPE CASING SHALL BE SIX (6) INCHES. ADDITIONAL PIPE BEDDING SHALL BE PLACED EQUAL TO HALF THE DIAMETER OF PIPE CASING OR SIX (6) INCHES WHICHEVER IS LESS.

GENERAL NOTES

1. TRENCHING AND PIPE INSTALLATION SHALL MEET THE REQUIREMENTS OF WSDOT STANDARD SPECIFICATION 7-08
2. MAXIMUM TRENCH WIDTH SHALL NOT EXCEED THE CASING / PIPE DIAMETER PLUS AN ADDITIONAL ONE FOOT ON EITHER SIDE OF THE CASING / PIPE.
3. COMPACTION SHALL BE METHOD C PER SECTION 2-03.3 (14)C
4. CASING PIPES SHALL EXTEND A MINIMUM OF SIX (6) FEET BEYOND THE TOE OF FILL SLOPES, BOTTOM OF DITCHLINE, OR OUTSIDE OF CURB.

APPLICATION:	UTILITY TRENCH BACKFILL DETAIL	 Washington State Department of Transportation WSDOT Utility Accommodation	
APPROVALS:			
REVISER: March 2012			DATE:

Utility Trench Backfill Detail

	<i>Page</i>
Policies Governing Accommodation Documents	C-2
Links to Resources	C-3
Reference Publications	C-4

Policies Governing Accommodation Documents

The policies governing Accommodation Documents include the following:

1. American Association of State Highway and Transportation Officials (AASHTO). (See AASHTO publications in [Reference Publications](#).)
2. American Society of Civil Engineers (ASCE). (See ASCE publications in [Reference Publications](#).)
3. [RCW 19.122](#), Underground utilities. Assigns responsibilities for locating and keeping accurate records of utility locations; protecting and repairing damage to existing underground facilities; and protecting the public health and safety from interruption in utility services caused by damage to existing underground utility facilities.
4. [RCW 47.24](#), City streets as part of state highways. Provides guidance on utility facilities within incorporated cities and towns on non-limited access controlled highways ([RCW 47.24.020](#)).
5. [RCW 47.44](#), Franchises on state highways.
6. [RCW 47.52](#), Limited Access Facilities. Provides guidance on utility facilities within incorporated cities and towns on limited access controlled highways ([RCW 47.52.090](#)).
7. USDOT, Federal Highway Administration (FHWA). (See FHWA publications in [Reference Publications](#).)
8. [WAC 468-34](#), Utility lines – Franchises and permits.
9. Washington State Department of Transportation's (WSDOT's) [Utilities Accommodation Policy](#). This publication includes [WAC 468-34](#); Requirements Involving Underground Utility Encroachments; Control Zone Guidelines; Scenic Classification for Utilities Accommodation on State Highway Right of Way; and Utilities Scenic Classification of State Highways.

Links to Resources

Agreements Manual

www.wsdot.wa.gov/Publications/Manuals/M22-99.htm

Annual Collision Data Summaries

www.wsdot.wa.gov/mapsdata/tdo/accidentannual.htm

Annual Traffic Report

www.wsdot.wa.gov/mapsdata/tdo/annualtrafficreport.htm

Engineering Publications Manual Index

www.wsdot.wa.gov/publications/manuals/index.htm

Environmental Procedures Manual

www.wsdot.wa.gov/Publications/Manuals/M31-11.htm

Governor's Executive Order 5-05 – Archaeological Discoveries

www.governor.wa.gov/execorders/eo_05-05.pdf

Highway Runoff Manual

www.wsdot.wa.gov/Publications/Manuals/M31-16.htm

Highways Over National Forest Lands

www.wsdot.wa.gov/Publications/Manuals/M22-50.htm

Hydraulics Manual

www.wsdot.wa.gov/Publications/Manuals/M23-03.htm

Manual on Uniform Traffic Control Devices (MUTCD)

www.wsdot.wa.gov/Publications/Manuals/MUTCD.htm

MUTCD Traffic Operations

www.wsdot.wa.gov/biz/trafficoperations/mutcd.htm

Standard Plans for Road, Bridge, and Municipal Construction

www.wsdot.wa.gov/Publications/Manuals/M21-01.htm

Standard Specifications for Road, Bridge, and Municipal Construction 2008

www.wsdot.wa.gov/Publications/Manuals/M41-10.htm

State Highway Log

www.wsdot.wa.gov/mapsdata/tdo/statehighwaylog.htm

State Route Viewer

<http://srview.wsdot.wa.gov/>

Transportation Executive Order E 1023.02 – Public disclosure

www.wsdot.wa.gov/docs/OperatingRulesProcedures/1023.pdf

Transportation Executive Order E 1025.00 – Tribal Consultation

www.wsdot.wa.gov/docs/OperatingRulesProcedures/1025.pdf

Utilities Accommodation Policy

www.wsdot.wa.gov/Publications/Manuals/M22-86.htm

Washington State's Strategic Highway Safety Plan: TARGET ZERO

www.wsdot.wa.gov/NR/rdonlyres/BC9C8BDB-A735-4948-850A-47B72696E4D9/0/SHSPFinal.pdf

WSDOT Forms

www.wsdot.wa.gov/forms/

Reference Publications

Each Region Utility Office should maintain a reference copy of the publications listed below. Please ensure you are using the most current published and department-accepted version of the publications.

WSDOT Publications	Publication Number
<i>Bridge Design Manual</i>	M 23-50
<i>Construction Manual</i>	M 41-01
<i>Design Manual</i>	M 22-01
<i>Environmental Procedures Manual</i>	M 31-11
<i>Highway Runoff Manual</i>	M 31-16
<i>Hydraulics Manual</i>	M 23-03
<i>Plans Preparation Manual</i>	M 22-31
<i>Roadside Manual</i>	M 25-30
<i>Standard Plans for Road, Bridge, and Municipal Construction</i>	M 21-01
<i>Standard Specifications for Road, Bridge, and Municipal Construction</i>	M 41-10
<i>Traffic Manual</i>	M 51-02
<i>Utilities Accommodation Policy</i>	M 22-86
<i>Work Zone Traffic Control Guidelines</i>	M 54-44

FHWA Publications

- *Program Guide – Utility Relocation and Accommodation on Federal-Aid Highway Projects*, Sixth Edition, January 2003
- *Highway/Utility Guide*, Publication No. FHWA-SA-93-049, June 1993
- *Manual on Uniform Traffic Control Devices (MUTCD)*

AASHTO Publications

- *A Guide for Accommodating Utilities within Highway Rights-of-Way*, 2005
- *A Policy on the Accommodation of Utilities Within Freeway Right-of-Way*, 2005
- *Right of Way and Utilities Guidelines and Best Practices*, January 6, 2004

ASCE Publications

- Construction Institute and the American Society of Civil Engineers (CI/ASCE) *Standard Guidelines for the Collection and Depiction of Existing Subsurface Utility Data*, CI/ASCE 38-02

	<i>Page</i>
Revised Code of Washington (RCW) References	D-2
Washington Administrative Code (WAC) References	D-6

Revised Code of Washington (RCW) References

The following is compilation of RCW references identified in the past, with brief descriptions of each code. Additional legal references may be identified as pertinent in the future; always refer to the current versions when researching legal status. For exact terms, see the individual law and consult WSDOT Assistant Attorney Generals (AAGs) as needed.

Title/Chapter	Purpose
4.24.115	Validity to indemnify
4.24.360	DOT cannot transfer utility relocation delay responsibility by contract clause to contractor
8	Eminent Domain
8.26	Relocation assistance
19.28	Electrical installations
19.28.141	Electrical inspections on highway R/W
19.122	Underground utilities – LOCATE
35	Cities and Towns
35.75.060	Street & road funds for bicycle transportation paths
35.99	Telecommunications, cable television service – Use of R/W – Request conduit
35A.14.900	State franchise cancelled if area annexed by city
36.75.090	Certification of abandoned state highways
36.75.250	Maintenance by state if county fails to perform agreed maintenance
39.34	Interlocal Cooperation Act
39.34.030	Agreements/financing for joint projects
39.34.040	File agreement with county auditor or post on agency website prior to entry into force – Real party in interest
39.34.050	Submit agreement to jurisdictional power
39.92	Local transportation act
43.09.210	Surplus property
43.17.240	1% per month interest on debts owed the state
43.21C	State environmental policy
43.88.160	Fiscal management – Powers and duties of officers and agencies
43.88.160(5)(e)	Payment only after services rendered
47	Public Highways and Transportation
47.01.260	Authority of department
47.01.260(1)	DOT shall exercise powers & perform duties; examine & allow or disallow bills
47.01.260(2)	DOT may indemnify contracting party against specific loss
47.01.260(3)	DOT may acquire property for system and to accommodate persons traveling
47.01.260(4)	DOT may engage in planning, research, and testing
47.01.290	Environmental review of transportation projects – Continuous process with regulatory authorities; comprehensive environmental approach critical
47.12.150	DOT may acquire/exchange replacement utility lands where projects have need

Title/Chapter	Purpose
47.17	State highway routes defined
47.24	City streets as part of state highways
47.24.010	DOT shall determine which streets form a part of the state highway: certify to city
47.24.020	Jurisdiction of state and city
47.24.020(1)	DOT must secure city approval to change grade except on L/A highway
47.24.020(2)	City responsible beyond curbs or portion of highway used for highway purposes; title to L/A R/W vests in state
47.24.020(3)	DOT may prohibit overhead banners, etc., less than 20 ft above roadway
47.24.020(4)	City shall maintain underground facilities; restoration to meet DOT requirements
47.24.020(5)	City may grant right to open surface; restoration to meet DOT requirements
47.24.020(6)	City shall provide illumination, street /inlet cleaning, snow removal, except state shall plow snow when necessary; state assumes slope responsibility for safety with city population 25,000 or less; 3 yr transition period when reaching 25,000 population; state illumination of any L/A facility
47.24.020(7)	DOT has right to use storm sewers, solely construct/share drain improvement costs
47.24.020(8)	City has exclusive right to grant franchises not in conflict with state laws <u>and rules</u> ; state is authorized to enforce franchises; DOT approves public transportation franchises
47.24.020(9)	City franchises must require roadway restoration to DOT requirements
47.24.020(10)	City issues overload, etc., permits subject to DOT printed regulations
47.24.020(11)	City regulates & enforces traffic/parking; state approves regulations not identical to state law
47.24.020(12)	DOT responsible for route markers & directional signs—not street signs
47.24.020(13)	DOT responsible for traffic control signals, signs, and devices in cities with 25,000 population or less; Cities in excess of 25,000 population shall install and operate signals, signs, and devices at their expense
47.24.020(14)	Parking revenue belongs to city
47.24.020(15)	R/W acquired by either; title vests in city
47.24.020(16)	City failure to perform obligations may result in state performance at city expense per RCW 47.24.050
47.24.030	Acquisition of R/W – DOT may acquire R/W including via condemnation
47.24.040	Street Fund – Expenditures – City MV Funds shall be disbursed for hwy/ street purposes
47.24.050	Aid on streets by state or county – State or county may be authorized to assist city and be paid from city MV Funds
47.26	Transportation Improvement Board – Development in urban areas – Urban arterials – Small city paving
47.28	Construction & maintenance of highways; minimum R/W width 100'; plans, bidding, state forces; flood damage
47.28.140	Cooperative agreements
47.30	Trails and paths

Title/Chapter	Purpose
47.44	Franchises on state highways
47.44.010	Franchise – Application & hearing rules
47.44.010(1)	DOT may grant utility & urban transportation use of state highway
47.44.010(2)	Application written, signed, & name jurisdictions
47.44.010(3)	DOT shall adopt hearing rules where utility construction disrupts traffic or surrounding environment
47.44.020	Grant of franchise – Conditions & hearing
47.44.020(1)	DOT may grant with reasonable compensation where utilities will least interfere
47.44.020(2)	DOT must conduct any hearing – utility to produce facts
47.44.020(3)	Franchise subject to removal at holder expense or RCW 47.44.030 (reimbursable)
47.44.020(4)	Utility is liable for personal injury or damages, for state inspection & loss of pavement life: non-exclusive franchise – life not to exceed 50 yrs
47.44.020(5)	Franchisees may make claim against others in joint trench situations
47.44.030	Removal – Notice – Reimbursement: Where DOT deems it necessary for safety, construction, maintenance, etc., DOT shall notify utility to remove at utility's expense or reimbursable notwithstanding contrary law when Fed pays 90% on National Highway System (NHS)
47.44.031	Removal – Limitation reimburse only after June 30, 1959
47.44.040	Franchises across joint bridges – DOT may join other jurisdictions in granting franchises on jointly owned bridges
47.44.050	Permit for short distances
47.44.050(1)	Permit for no longer than 300 ft along highway, apply, may be cancelled on 30 days notice, removal by law
47.44.050(2)	Permit holder financially responsible for trenching not completed & loss of pavement life; may claim against joint trench partners
47.44.060	Penalties
47.44.060(1)	Unlawful occupancy is a "daily" misdemeanor
47.44.060(2)	Unlawful occupancy is liable for civil penalty of \$100 per day, 45 days after receipt of notice from DOT
47.44.060(3)	Unlawful occupancy beyond 45 days may result in state removal at utility's expense
47.44.070	Toll facility franchises re: RCW 47.56.256 (ferry & toll facilities)
47.44.081	Chapter does not apply to wireless service facilities re: RCW 47.04.045
47.44.150	Measure of damages – State liability for state damage to utility facility limited to cost of repair and recoverable only where utility is legally authorized; also see RCW 19.122.070(1) {\$1,000 civil penalty where non-explosive} (2) {treble damages for malicious damage to a field marked underground facility} & where notice is not given in compliance with RCW 19.122.030 {2 business days' notice for any excavation over 12 inches deep}
47.50	Highway access management – developer intersection construction
47.52	Limited Access Facilities

Title/Chapter	Purpose
47.52.090	Cooperative Agreements – Urban Trans – Title to Highway – Traffic Regs – Underground utilities & overcrossings – Passenger transportation – Storm sewers – City street crossings
47.52.090(1)	Cities regulate traffic except as provided in RCW 46.61.430
47.52.090(2)	City or franchise holder shall maintain & construct underground or overhead utilities at their expense, when such facilities do not conflict with L/A highway purposes under department permit. State pays for city overhead relocation when constructing L/A facility.
47.52.090(3)	Cities have right to grant franchises Xing underground when not inconsistent with L/A highway purposes & not in conflict with state law. State has right to enforce conditions of city franchises. Public transportation system must have acceleration, deceleration and turnout lanes on L/A highways. City franchises must require repair of L/A surface.
47.52.090(4)	DOT has right to use storm sewer system if capacity available
47.52.090(5)	Construction & maintenance of city streets as L/A facilities in accordance with governing policy agreement between DOT and association of cities
47.52.210	Property title upon construction of limited access highway
47.56.256	Franchises for utility, rail and urban transportation purposes; DOT may grant franchises on toll & ferry facilities
54.04.045	Locally regulated utilities (PUDs) not under WUTC control
65.08.095	Conveyance of title by public bodies
79.90.575	Easement fees – DNR
80.32.010	City & county may franchise utilities – Roads must be restored
80.36.040	Telecoms have right to occupy “Land Granted” or U.S. donated, hwy & RR R/W
81.53	Railroad crossings

Washington Administrative Code (WAC) References

The following is compilation of WAC references identified in the past, with brief descriptions of each code. Other WACs may be identified as pertinent in the future; always refer to the current versions of the code. For exact terms, see the individual code and consult WSDOT Assistant Attorney Generals (AAGs) as needed.

Title/Chapter	Purpose
197	Department of Ecology
197-11	SEPA rules
296	Department of Labor and Industries
296-155-525	Safety standards for construction work (derricks and cranes)
296-155-650	Excavation, trenching, and shoring (scope, application, and definitions)
458	Department of Revenue
458-20-170	Taxes on construction
458-20-171	Taxes on city property
468	Department of Transportation
468-12	State Environmental Policy Act rules – DOT
468-18	City/county project coordination
468-18-010	Project consent by local governing body
468-18-030	Use of county roads as project haul roads
468-18-040	Design standards for rearranged county roads, intersections, ramps, & crossings
468-18-040(1)	Early review by state & county
468-18-040(2)	Design standard not less that DOT; exception: when individual counties adopt higher standards
468-18-040(3)	R/W dedeed to or easement for county road meets minimum Arterial standards
468-18-040(4)	Construction shall include all MUTCD-required traffic and safety devices
468-18-040(5)	Agreement negotiated prior to R/W Plan approval, with particular items
468-18-050	Jurisdiction @ intersections of state highways and city streets
468-30	Turnback to cities and counties
468-30-070	Procedure for transfer of abandoned state highways to counties
468-30-075	Procedure for transfer of abandoned state highways to cities and towns
468-34	Utility lines – Franchises & Permits
468-34-010	Applications
468-34-010(1)	Submit on DOT forms
468-34-010(2)	Include facility description plus plans & data for Category 1 & 2
468-34-010(3)	Compliance with DOT ACCOMMODATION POLICY
468-34-010(4)	Discuss alternate possibilities when on L/A highway
468-34-020	Costs
468-34-020(1)	Applicant pays reasonable costs in Table of Fees plus additional expenses, unless U.S. or its agencies or a utility is relocating from easement
468-34-020(2)	Utility company pays portion of added design and construction costs for highway structures where the utility company is required to relocate at their expense

Title/Chapter	Purpose
468-34-020(3)	Sureties: individual bonds \$1,000 min for 1 yr on slope work and 2 yrs on travel or shoulder; in lieu, a blanket surety \$10,000 minimum
468-34-030	Determination of need for hearing
468-34-030(1)	DOT determines need for hearing if construction may:
468-34-030(1)(a)	Significantly disrupt traffic flow or driveway use
468-34-030(1)(b)	Cause significant & adverse environmental effect
468-34-030(2)	In public interest involving the following:
468-34-030(2)(a)	Overhead 35kV or greater
468-34-030(2)(b)	Pipeline 18 inch or larger diameter
468-34-030(2)(c)	Conduits with trench wider than 3 ft
468-34-030(2)(d)	Transmittants unstable and diameter over 4 inch
468-34-030(2)(e)	Pressurized pipes over 12 inch
468-34-030(2)(f)	Underground installations requiring excavation through landscaping maintained by permitted abutters
468-34-030(3)	DOT may dispense with hearing requirements if applicant has direct contact with abutting owners
468-34-030(4)	Application with DOT required hearing shall be processed in accordance with WAC 368-34-040 through WAC 368-34-090; application without required hearing may be approved without processing in accordance with the pre-stated WACs
IF A HEARING IS WARRANTED, SEE 468-34-040 – 468-34-090	
468-34-040	Franchise Hearings – DOT to arrange hearing ASAP if protest filed
468-34-050	Notice of Filing application for franchise – DOT shall publish notice of franchise application at applicant's expense once per week for 2 weeks
468-34-060	Protests – Must be written and mailed to DOT within 14 days of publishing
468-34-070	Uncontested applications – DOT may grant if protest not received in 14 days
468-34-080	Procedure on protests – DOT to take steps deemed necessary on the issues
468-34-090	Hearing Officers – Secretary designates qualified person who may:
468-34-090(1)	Administer oath, examine witness, & receive evidence
468-34-090(2)	Admit reasonable evidence & exclude incompetent evidence
468-34-090(3)	Rule on offers of evidence
468-34-090(4)	Regulate the course of the hearing
468-34-090(5)	Hold settlement conferences by consent of the parties
468-34-090(6)	Dispose of procedural requests
468-34-090(7)	Prepare the proposed order and submit to the secretary for consideration
468-34-100	Policy on accommodation of utilities on highway rights of way – Shall apply to all franchises & permits issued subject to RCW 47.44 and other than RCW 47.24
468-34-110	53 definitions, including access control and installation categories
468-34-120	Application of policy to various types of R/W
468-34-120(1)	Freeways – In accordance with AASHTO "A Policy on the Accommodation of Utilities on Freeway Rights of Way" 1982 & amendments, and this policy
468-34-120(2)	Limited access highways – Same as freeways

Title/Chapter	Purpose
468-34-120(3)	Conventional highways – Rural – In accordance with this policy
468-34-120(4)	Conventional highways – Cities – In accordance with:
468-34-120(4)(a)	Underground
468-34-120(4)(a)(i)	Water & sewer – Current Standard Specs
468-34-120(4)(a)(ii)	All other facilities shall be in accordance with this policy
468-34-120(4)(b)	Overhead – In accordance with this policy
468-34-130	Location
468-34-130(1)	To minimize later adjustment, permit service, in accordance w/Control Zone
468-34-130(2)	Near R/W line in a uniform alignment
468-34-130(3)	Crossings shall be as normal to centerline as practical; crossings more than 45° from normal shall be considered longitudinal except at intersections
468-34-130(4)	DOT establishes horizontal offset
468-34-130(5)	Vertical location to comply with current standard “underground” and WAC 468-34-290 “overhead”
468-34-130(6)	Full consideration to visual quality, engineering principles, & economics
468-34-130(7)	DOT installations in accordance with this policy
468-34-130(8)	DOT may restrict number of service connections & require more than one distribution line
468-34-140	Utility tunnels/bridges – DOT to ensure study by companies to anticipate joint tunnel or bridge
468-34-150	Design
468-34-150(1)	Utility responsible for design; DOT shall review including structural integrity of roadway & utility
468-34-150(2)	Utility installations to comply with the following:
468-34-150(2)(a)	Electric & communication facilities comply with NEC and/or WA St Safety Code
468-34-150(2)(b)	Water lines conform with Standard Specs, including, but not limited to: <ul style="list-style-type: none"> • Welded Steel Water Pipe – AWWA C201; ASTM A 120; AWWA C203; AWWA C205 • Reinforced Concrete Water Pipe – AWWA C300; C301; C302 • Cast Iron Water Pipe – AWWA C106; C108; C111 • Wrought Iron Water Pipe – ASTM A72
468-34-150(2)(c)	Pressure Pipeline shall conform with Standard Code for Pressure Piping – American National Standards Institute & applicable industry codes, including:
468-34-150(2)(c)(i)	Power Piping – ANSI B 31.10
468-34-150(2)(c)(ii)	Petroleum Refinery Piping – ANSI B 31.3
468-34-150(2)(c)(iii)	Liquid Petroleum Transportation Piping System – ANSI B 31.4
468-34-150(2)(c)(iv)	CFR 49, 192, Transport of nat gas/other gas by pipeline – Min Fed Safety Stds
468-34-150(2)(c)(v)	Liquid Petroleum pipeline conform with recommend practice of American Petroleum Institute for Pipeline Crossings under RR & Highway
468-34-150(3)	Ground-mounted facilities shall be compatible with visual quality of highway
468-34-150(4)	Utility installations shall be durable and free from routine service

Title/Chapter	Purpose
468-34-150(5)	Utility installations shall provide for known or planned expansion
468-34-150(6)	Government or industry codes shall be followed, including DOT design standards providing for the protection of the highway
468-34-160	Permits & franchises required except as provided in WAC 468-34-180
468-34-170	All permits & franchises shall:
468-34-170(1)	Incorporate pertinent provisions of this policy as to location, construction, traffic protection, maintenance, access restriction, preservation of visual quality, & special conditions as deemed appropriate by DOT
468-34-170(2)	Describe facility: size, type, nature, & extent
468-34-170(3)	Exhibits depicting:
468-34-170(3)(a)	Existing or proposed relation to highway
468-34-170(3)(b)	Existing or planned highway improvements
468-34-170(3)(c)	Right of way
468-34-170(3)(d)	Control of access and access points
468-34-170(4)	Summarize effects on aesthetics of R/W & visible features
468-34-170(5)	Specify liability and responsibilities assc with adjustments for hwy improvements
468-34-170(6)	Specify the effect of noncompliance with conditions thereof
468-34-170(7)	Contain terms pledging utility to not disfigure roadside appearance
468-34-170(8)	Contain a certification of compliance with Control Zone guidelines
468-34-180	Accommodation where utility has prior right – DOT & utility may enter into agreement for common use
468-34-190	Pipelines – Location and alignment
468-34-190(1)	Crossing angle based on economic alternates, as near normal as practical
468-34-190(2)	Crossings should avoid difficult areas: deep cuts, footings, rocky, drainage areas
468-34-190(3)	Longitudinal installations shall be parallel near R/W; median installs as defined in WAC 468-34-110(7&8) are variance from policy; variance must demonstrate that:
468-34-190(3)(a)	Installation will not adversely affect highway
468-34-190(3)(b)	Alternates would create undue hardship or financial burden due to terrain, geology, or environmental damage
468-34-190(4)	Trenched crossing in roadway per WAC 468-34-110(7) is variance from policy & request shall comply with (3)(a) & (3)(b) above
468-34-200	Pipelines – Cover
468-34-200(1)	Top of pipe shall comply with the applicable Design Standard for Underground Utility Encroachment – Added auxiliary name to “minimum cover detail”
468-34-200(2)	Where less than minimum cover is necessary, reroute, protect w/casing/ concrete slab
468-34-200(3)	Cover for unstable transmittants shall not be reduced below safety limits specified in industry standards
468-34-210	Pipelines – Encasement
468-34-210(1)	Casings shall not be required for:

Title/Chapter	Purpose
468-34-210(1)(a)	Pipelines conveying natural & other gas that meet 49 CFR 192 & WAC 480-93
468-34-210(1)(b)	Local service natural or other gas meeting 49 CFR 192 & WAC 480-93
468-34-210(2)	Casings shall be required for:
468-34-210(2)(a)	Pipeline crossings where casing is required by industry standard or special conditions
468-34-210(2)(b)	Pressurized carriers & carriers of unstable transmittants other than natural gas
468-34-210(2)(c)	Installations where probability of damage exists
468-34-210(3)	Casing may be required for protection from external loads/shock, such as hwy construction
468-34-210(4)	Casing pipes shall extend 6 ft beyond toe of fill, back of ditch or outside curb unless limited by restrictive local conditions; casing need not be continuous across median or adjacent to frontage road
468-34-210(5)	Casings shall be sealed at ends
468-34-210(6)	Casing design to support load of hwy and superimposed loads thereon, as minimum shall equal the structural requirements of highway drainage facilities
468-34-220	Pipelines – Appurtenances
468-34-220(1)	Vents shall be required for casings carrying fuel per CFR 49, Part 192; vents shall be located so as not to interfere with hwy maintenance or be concealed by vegetation; preferably, they should stand near fence
468-34-220(2)	Drains required for casings
468-34-220(3)	Markers shall be conspicuous; 1 @ normal Xing; 2 @ oblique Xing; every 500 ft longitudinal; information required
468-34-220(4)	Manholes shall not be located in pavement or shoulders of L/A hwy
468-34-220(5)	Automatic shut-off valves shall be installed near ends of structures/hazards, etc.
468-34-220(6)	Aboveground appurtenances shall be loc in accordance with Control Zone guidelines
468-34-230	Pipelines – Uncased carriers
468-34-230(1)	Carrier pipe shall conform to industry and government standards
468-34-230(2)	Carrier pipe shall be designed to support load from zero to max pressure
468-34-230(3)	Suitable bridging, slab or other measure shall be used to protect carrier pipes where vulnerable to hwy construction or maintenance damage
468-34-230(4)	Existing carrier pipes may remain if DOT & utility agree they will be structurally sound and operationally safe
468-34-240	Pipelines – Restrictions against varied use
468-34-240(2)	Change in class of transmittant or increase in maximum working pressure shall require DOT approval
468-34-250	Pipelines – Installations – Shall be by end-product specs and the following:
468-34-250(1)	Pipeline install requests shall specify class of transmittant, maximum working pressure, test or design pressure, and design standards for the carrier
468-34-250(1)	Trenched construction and backfill features are:
468-34-250(1)(a)	Restoration of roadbed

Title/Chapter	Purpose
468-34-250(1)(b)	Pipe secure against deformation leading to leakage
468-34-250(1)(c)	Assurance against trench becoming drain channel or blocking drainage
468-34-250(2)	Trenched Construction – Bedding and backfill:
468-34-250(2)(a)	Trench shall have vertical faces; maximum width of 2 ft greater than OD of pipe; shoring complies with L&I
468-34-250(2)(b)	Minimum bedding depth shall be the lesser of 6 inches or half the diameter of the pipe, be granular material
468-34-250(2)(c)	Backfill shall be placed in two stages
468-34-250(2)c(i)	Sidefill to top of pipe level
468-34-250(2)c(ii)	Overfill to former grade surface; sidefill and overfill in 6-inch layers, tamp and add moisture to achieve 95% density per std specs; additional cutback of base and surfacing to transition to trench shoulders as directed by DOT
468-34-250(3)	Untrenched construction required on all L/A hwy crossings and:
468-34-250(3)(a)	Untrenched construction shall extend 6 ft outside the roadway prism
468-34-250(3)(b)	Untrenched technique to be approved by DOT
468-34-250(3)(c)	Untrenched opening shall not exceed 5% over the OD; backfill (pressure grout) required for pipes over 12-inch diameter
468-34-250(3)(d)	Overbreaks, unused holes, or abandoned casings shall be backfilled as directed by DOT
468-34-260	Pipelines – Adjustment
468-34-260(1)	Existing pipeline should be adjusted in plan and/or grade when top of pipe is less than the requirements of standard design plate for underground utility encroachments – Added auxiliary name
468-34-260(2)	Pipeline should be encased/protected if it would be required for a future pipeline
468-34-260(3)	Pipeline with inadequate cover for live loads may be protected by a slab
468-34-260(4)	Notwithstanding reinforcement or protection, construction contractor shall be warned and made responsible within the construction zone; temporary cover should be arranged
468-34-270	Installations on hwy structures – May be allowed in accordance with following:
468-34-270(1)	Each attachment shall be considered individually
468-34-270(2)	Attachment considered only if bridge can adequately support & not compromise highway features or ease of maintenance
468-34-270(3)	Utility positions that inhibit maintenance not allowed; manholes not allowed on overcrossings
468-34-270(4)	Avoid attachment of hazardous transmittants where practical
468-34-270(5)	Utility attachment shall not reduce critical vertical clearance
468-34-270(6)	Utility attachment shall be beneath structure floor and between girders or within a cell; avoid attachments outside of bridges where there are alternatives
468-34-270(7)	Mountings shall be of a type that will not create noise
468-34-270(8)	Hole in abutment must be of minimum size to and sealed
468-34-270(9)	Utility should curve to outside roadway ASAP after leaving bridge

Title/Chapter	Purpose
468-34-270(10)	Hangers to be suspended from inserts/clamped to flange of substruct member
468-34-270(11)	Construction shall comply to applicable codes, standards, & specs
468-34-270(12)	Utility responsible for restoration of disturbed portions
468-34-270(13)	Communication & electric attachment shall be grounded and conduited from manholes at each end of structure
468-34-270(14)	WAC 468-34-210 (encasement) shall apply to bridge installations
468-34-280	Overhead power and communication lines – Type of construction – Longitudinal installations should be single pole and joint use desirable
468-34-290	Vertical Clearance – Shall comply with National Electrical Safety Code or the following, whichever is greater: See Table
468-34-290(1)	Minimum height of highway crossing measured at roadway
468-34-290(2)	Minimum height of longitudinal installation measured from ground
468-34-290(3)	Clearances shall be at State Electrical Construction Code temperature and loading standards
468-34-300	Overhead lines – Location
468-34-300(1)	Poles in accordance with Control Zone guidelines
468-34-300(2)	Guy wires and stub poles shall be located in accordance with Control Zone guidelines
468-34-300(3)	Pole/underground installation alignment may vary where irregular shaped R/W exists
468-34-300(4)	Poles and related facilities shall be located as near as practical to R/W
468-34-310	Underground power and communication lines
468-34-310(1)	General controls relative to pipelines apply
468-34-310(2)	General controls set forth in WAC 468-34-270 relative to structures apply
468-34-310(3)	Installations should reflect future highway or utility enlargement
468-34-310(4)	Manholes shall be designed and located to cause least interference
468-34-310(5)	New underground installations may be permitted in scenic areas where extensive visual quality is not impaired
468-34-320	Conversion to underground or relocation of overhead lines – Responsibility – The following methods of sharing cost responsibility shall pertain:
468-34-320(1)	Where an aerial franchise exists and for reasons of visual quality, DOT desires undergrounding to serve the highway purpose, DOT will pay. [Note: Check with Headquarters before implementing this WAC.]
468-34-320(2)	New franchises where DOT determines (based on Scenic Class – WAC 468-34-330), that facility shall be placed underground, utility pays; when amending/ renewing franchise the first time after August 20, 1974, undergrounding or relocation at util expense at time of reconstruction or within the renewal period
468-34-320(3)	Within limits of a highway project, the costs responsibilities are as follows:
468-34-320(3)(a)	Utility pays expenses for that portion that must be relocated within the limits of physical construction
468-34-320(3)(b)	DOT pays for that portion of aerial line not physically affected by construction

Title/Chapter	Purpose
468-34-330	Scenic enhancement
468-34-330(1)	Undergrounding requirements for Scenic Class A, B, C, D, AX, BX
468-34-330(2)	Special exceptions
468-34-330(3)	Scenic Classifications – A, B, C, D, X; General criteria, scenic values
468-34-340	Miscellaneous
468-34-340(1)	Preservation, restoration, and cleanup
468-34-340(2)	Safety and convenience
468-34-350	Utility installations shall be in accordance with Control Zone Guidelines
468-51	Highway access management access permits – Administrative process
468-52	Defines five (5) highway access management classification systems
468-54	Defines “full,” “partial,” & “modified” limited access highway
468-58	Guidance and policies on limited access facilities
468-58-080	Control of access on crossroads and interchange ramps
480	Utilities and Transportation Commission
480-04 to 480-120	Regulate: motor carriers, transportation companies, railroads, refuse collection, and non-public utility companies (liquid oil and gas pipelines, natural gas, electric, water, telephone)

Effective April 4, 2016

The Roadside Safety Analysis Program (RSAP) utilizes variable factors that directly influence the outcomes of the analysis. The following sections provide requirements for RSAP submittals to WSDOT, including changes to certain values, settings and acceptable manner of submittals. These requirements are broken out according to the different sections or tabs within RSAPv3. Unless otherwise specified below, the default factors in the RSAPv3 should be used.

Project

Design Life should be listed as the life of the franchise under which the facility is located – usually 25 years. If the facility is not located under a WSDOT franchise, consult with the Region Utilities Office on the appropriate design life.

Traffic

Traffic Growth Rate varies from location to location based on the character of the area. Consult with the Region Utilities Office on the appropriate traffic growth rate for the area.

% Trucks – If unknown, consult with the Region Utilities Office.

Highway

RSAP allows users to define the length of highway segment to be evaluated. For WSDOT submittals, the length of highway segment for each analysis should be defined according to the following parameters:

- The total segment to be evaluated under an individual RSAP analysis must only contain **10 or less** above-ground utility objects¹; Multiple analysis may be submitted within a single submittal if more than 10 objects are to be evaluated using RSAP.
- The segment should begin 200 feet before the first object and end 200 feet after the last object.
- Multiple sub-segments should be defined for an individual analysis if any highway characteristics, such as slope, curves, number of lanes, etc. are different within the above-described parameters.

Alternatives

RSAP is capable of assessing up to 5 alternative actions per analysis. Appropriate alternatives selected for the analysis should be determined by the utility, but verified with the Region Utilities Office **before** the analysis is performed. This is intended to eliminate instances of re-submittal if all appropriate alternatives may not have been considered, and/or inform WSDOT in advance on why certain alternatives are not practicable and therefore should not be evaluated.

¹ Only above-ground utility objects that are not compliant with control zone requirements need to be included. For example, objects less than 4 inches high from the ground, property shielded by guard rail with the appropriate offset distance or certified as break-away would not need to be included in the analysis.

Individual hazards within the highway segment should be limited to the utility objects only. Other hazards that may be located within the 200 feet before and after areas, as described in the “Highway” section, above, should not be listed for the purpose of the analysis. Those objects may be addressed through a separate analysis for the adjoining highway segment.

When filling in data about the nature of the hazard being considered, RSAP automatically assigns a value of 12 inches as the diameter for utility poles when they are selected from the drop down menu. This value should be changed as follows: Unless actual field measurements will be entered, a standard dimension of 14 inches may be entered for Distribution poles and a standard dimension of 20 inches may be entered for Transmission poles. In cases where larger poles or alternative pole structures occur in a run of poles or at significant locations, such as a pivot points or when oversize poles have been placed to eliminate guy lines, those poles should be field measured and actual dimensions entered into RSAP.

Costs associated with each alternative should be estimated according to the utility’s standard methodology for estimating projects or alterations. Because these cost estimating methodologies are outside of WSDOT’s control and vary widely, the utility must certify that the scope and costs are accurate, as further specified in the “Applicant Endorsement” section, below.

X-Section

An accurate cross-section must be plotted for the highway segment. If the segment contains varying slope characteristics, multiple cross sections should be plotted accordingly per sub-segments.

Hazards

This section establishes costs for repair and maintenance associated with different types of infrastructure, including utility poles and guardrail. The default value for utility pole repair after a crash is \$5,000. The utility may alter this amount to reflect more accurate costs for its infrastructure, if known.

Similarly, if guardrail is included as an alternative measure, costs associated with a particular type of guardrail design should be updated to reflect WSDOT’s typical maintenance and repair costs. The type of guardrail that will primarily be used for the purposes of utility RSAP submittals is identified by RSAPv3 as “TL3WbeamGR”. **The “Typical Repair Cost/Crash” for this type of guardrail should be changed to \$2,250.**

For other types of guardrail, WSDOT will provide these updates after jointly determining the type of guardrail that should be used as described above in the “Alternatives” section.

Note: Altering data in this section of RSAP is done by pressing Control-Shift-H; making changes; and pressing Control-Shift-E to activate the changes. **If any information apart from the specified guardrail repair costs are altered, the changes and explanation for the changes must be clearly stated within the written summary accompanying the RSAP submittal.**

Analyze

The default within the “Analyze” settings for the Maximum Trajectories for each Encroachment Location is 200. This value may be reduced to as low as 50 at the discretion of the utility. Reducing this value will sometimes allow the analysis to run more quickly.

The “Risk Analysis” option within the settings must be checked. as risk associated with the preferred alternative will be considered as part of WSDOT’s review.

Results

Once the analysis is complete, B/C results will be shown in the B/C results tab. RSAPv3 has a default of 2 as the “Decision Point Benefit Cost Ratio”. This value must be changed to 1, after which the B/C ratio will automatically be recalculated.

The Risk results will be shown in the “Risk” tab under Results. RSAP’s default risk analysis bases results on the probability of fatal or incapacitating crashes (represented in RSAP as “A+K” crashes). WSDOT is interested in knowing the probability of any injury-causing crashes associated with each alternative, which requires the following modifications to the default risk values:

In the “Crash Severity” cell at the top of the page, the default selection is “A+K”. From the drop-down menu in the Crash Severity cell, select “Injury.” After this is completed, the Maximum Acceptable Risk value should be changed from the default 0.01 to .0075.

Method and content of submittals

The preferred method of RSAP submittals will be via USB flash drive accompanied by a written summary of the analysis. Other forms of comparable electronic submittal, including the use of FTP sites, may be acceptable as long as WSDOT utilities staff can easily access the files. E-mail submittals are not feasible given the large size of the RSAP files. The electronic submittal must contain the full RSAP analysis in the form available through RoadSafe LLC. The written summary should list the alternatives considered, an itemized estimate supporting the costs associated with each alternative, an overview of the results – both Benefit/Cost and Risk, and an explanation of any unique aspects of the analysis as necessary.

Applicant Endorsement

All RSAP submittals must include the attached form signed by a duly authorized representative of the utility in order to be considered. Documentation may be requested by WSDOT that verifies the signature authorization is appropriately delegated.

**Applicant Endorsement
Scope and Cost of Alternatives within the Roadside Safety Analysis Program**

Applicant: _____

Utility Franchise/Permit No: _____

I hereby affirm that the scope of work and costs associated with each alternative strategy assessed as part of the attached analysis is a true and correct representation of the design and scope necessary to implement each alternative according to the utility's own minimum design standards, jurisdictional requirements, local conditions, and applicable industry standards; none of the alternatives were designed to include betterments, system upgrades, superfluous design elements, or other factors that would tend to inflate the associated cost of each alternative beyond minimum design and construction requirements necessary to accomplish the intended alternative.

By: _____

Print Name

Title: _____

Date: _____