

# 2022 Ramp & Roadway



Washington State Department of  
**Transportation**

**Northwest Region**  
Average Daily Volumes



## ***Table of Contents***

Summary Report.....	3
Legend.....	5
I-5.....	6
I-90.....	237
I-405.....	48
SR 18.....	64
SR 99.....	71
SR 167.....	76
SR 509.....	82
SR 518.....	86
SR 520.....	89
SR 522.....	95
SR 525.....	100
SR 526.....	102
SR 599.....	104
US 2.....	106
Appendix.....	108

# RAMP AND ROADWAY TRAFFIC VOLUME REPORT

## 2022 SUMMARY REPORT

---

During 2023, the Transportation Management Center (TMC) of the Northwest Region updated the 2022 Ramp and Roadway Volumes Report. Traffic counts were taken from January 2022 through December 2022 from vehicle detection loops.

The following interstate and state highways are included in this report:

- 1) I-5 from the Pierce County Line to the Stillaguamish River
- 2) SR-18 from I-5 to Issaquah-Hobart Road
- 3) I-90 from 4<sup>th</sup> Ave S in Seattle to High Point Road
- 4) SR-99 from SR-599 Pacific Hwy S to Ray St Seattle
- 5) SR-167 from the Pierce County Line to I-405
- 6) I-405 from I-5 in Tukwila to I-5 in Lynnwood
- 7) SR-509 from S 188<sup>th</sup> St to 1<sup>st</sup> Ave Bridge S
- 8) SR-518 from SR-509 to I-5
- 9) SR-520 from I-5 to SR-202 Redmond Way
- 10) SR-522 from 65<sup>th</sup> Ave NE to US-2
- 11) SR-525 from Alderwood Mall Blvd to SR-99 Pacific Hwy
- 12) SR-526 from Airport Rd to I-5
- 13) SR-599 from I-5 to SR-99 Pacific Hwy
- 14) US 2 from I-5 to Rice Rd

Average weekday volumes (AWD) were computed from Tuesday through Thursday data. AM and PM peaks correspond to the highest hourly volumes. If a peak occurred outside of 6:00 AM to 9:45 AM or 2:30 PM to 6:45 PM, it is indicated in the report with an asterisk (\*). The peak times for those locations were noted in the appendix.

NOTE: All roadway drawings are NOT drawn to scale.



## 2022 SUMMARY REPORT

---

Special thanks go to the Northwest Region Transportation Management Center engineers, technicians, and interns for their hard work in compiling and analyzing the data for this report.

An electronic copy of the ramp and roadway data sheets contained in this report is also posted on our website at the following address:

<https://wsdot.wa.gov/about/transportation-data/travel-data/ramp-roadway-report>

For more information on this report, please contact:

Transportation Management Center  
15710 Dayton Avenue North  
P.O. Box 330310  
Seattle, WA 98133-9710

Telephone: (206) 410-0006  
Fax: (206) 440-4804

# LEGEND

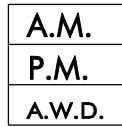

ramp volume



high-occupancy vehicle (HOV) lane volume



mainline volume  
(does not include HOV lane volume)

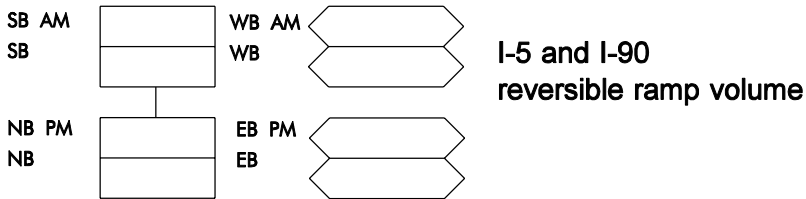
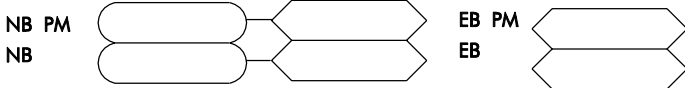
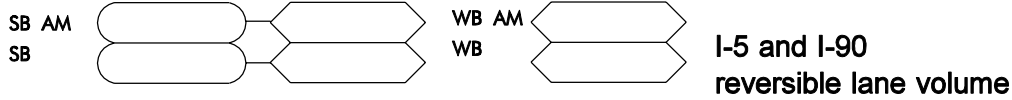

HOV facility



beginning or end of HOV facility



metered ramp shoulder



peak hour occurred outside of normal peak hour  
(6 to 9:45 AM or 2:30 to 6:45 PM; See Appendix)

S

speed data available at this location

T

data obtained from tube counters

A.M.

am peak hour volume

P.M.

pm peak hour volume

CONSTR

data not available due to construction

A.W.D.

average weekday volume

N.A.

data not available



Pierce County Line

S 375TH ST

Federal Way Weigh Station

Enchanted PKWY

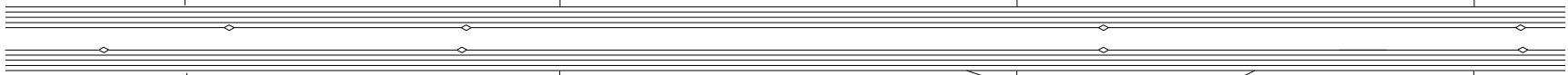
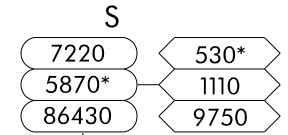
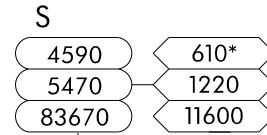
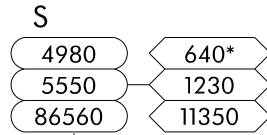
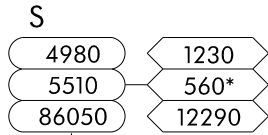

WEIGH STATION  
REST AREA

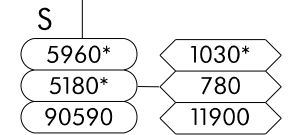
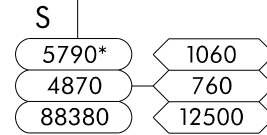
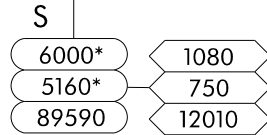
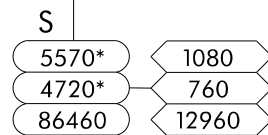
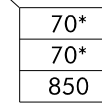
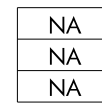

Washington State  
Department of Transportation



1  
OF  
31

EXIT 142A\B

SR 18

EXIT 143

S 320TH ST



S 317TH ST  
PARK & RIDE  
DIRECT ACCESS

S 308TH ST

S 336TH ST S 329TH ST

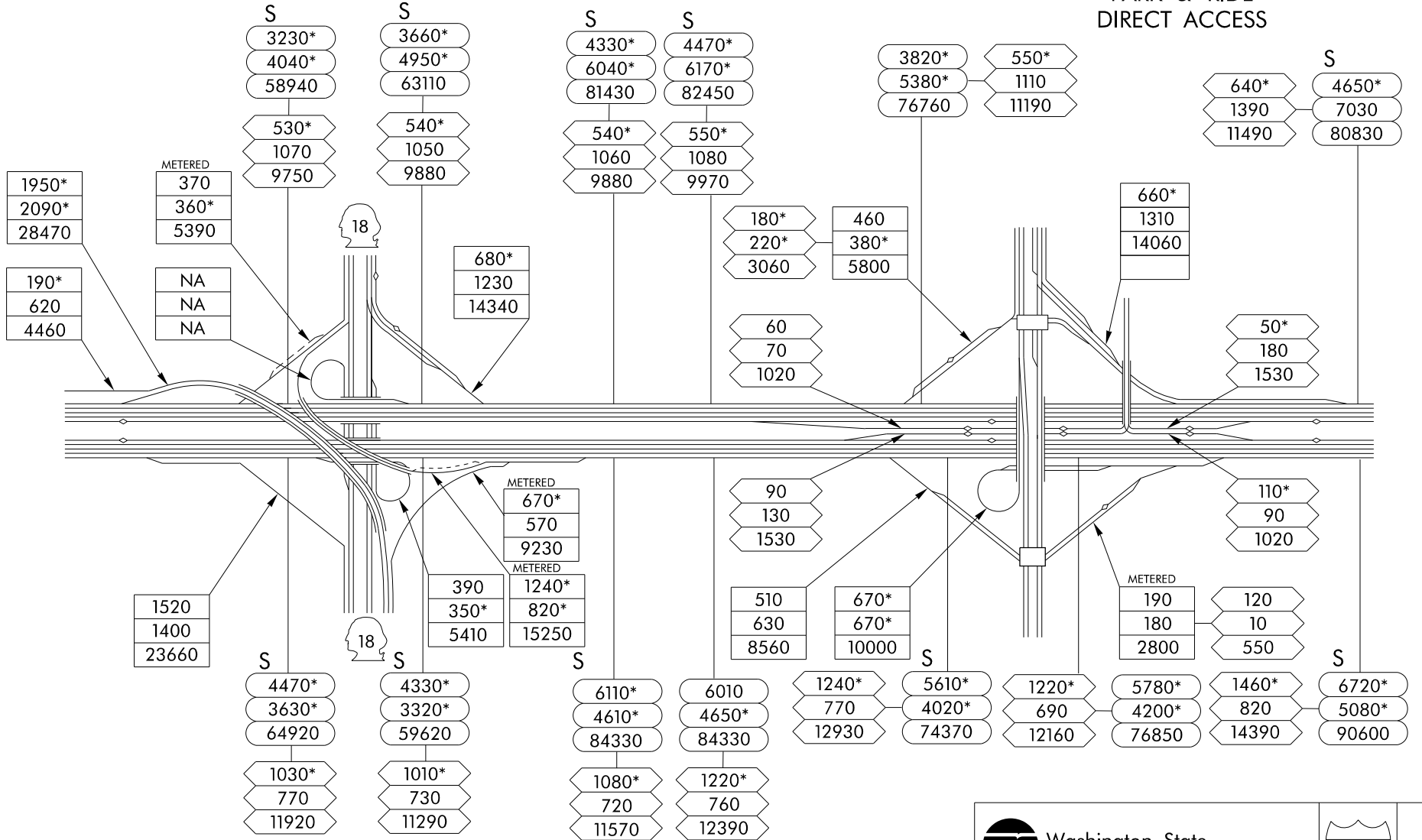

Washington State  
Department of Transportation



2  
OF  
31

S 298TH ST

S 289TH ST

S 280TH ST

EXIT 147

S 272ND ST

S 266TH ST

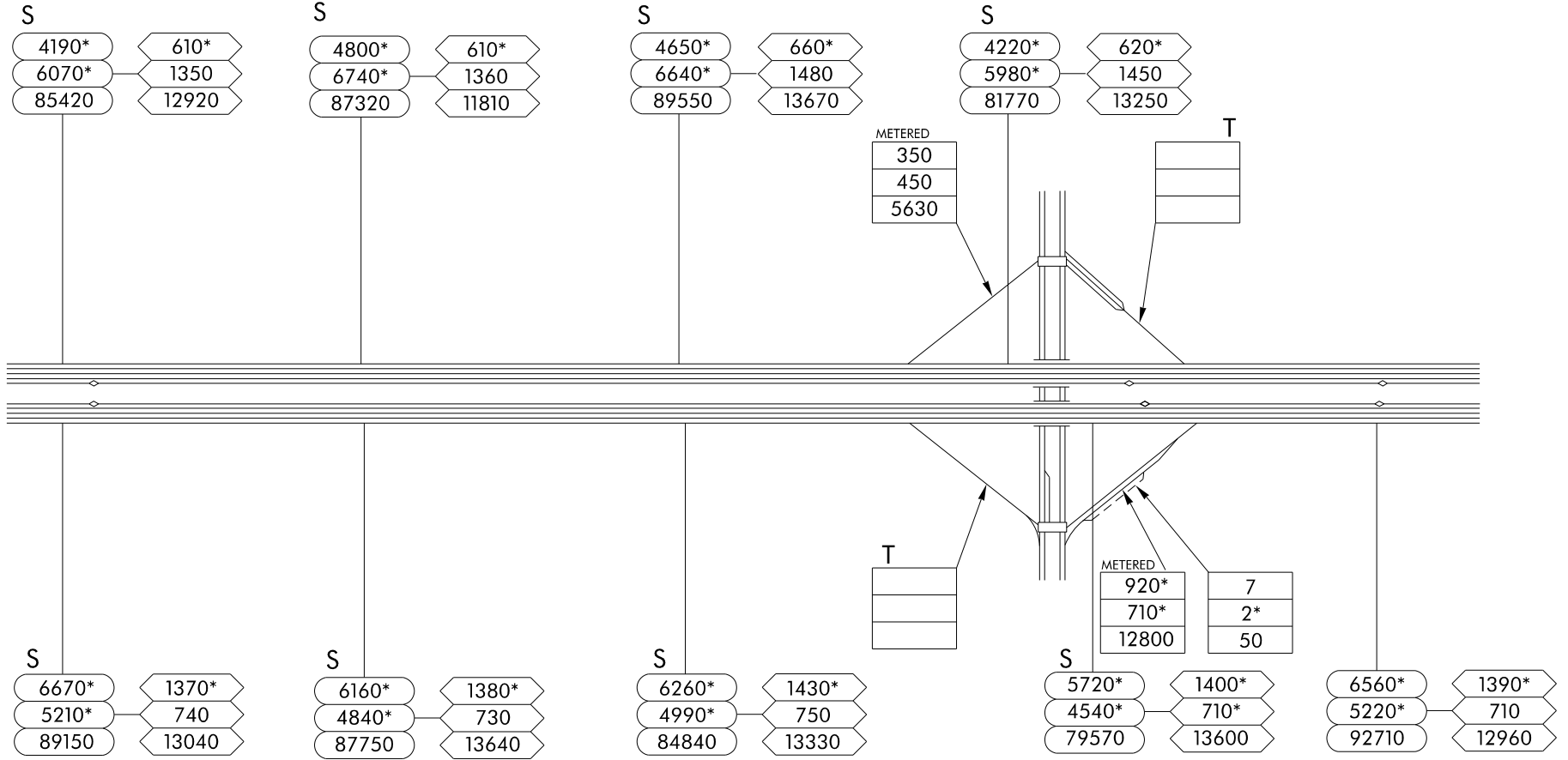

Washington State Department of Transportation



3 OF 31

S 260TH ST

S 252ND ST

S 243RD ST

EXIT 149A/B

SR 516

S 216TH ST



S

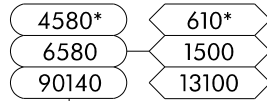
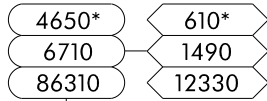

S

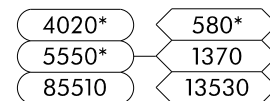
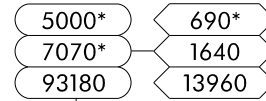

S

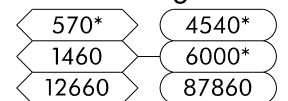

METERED

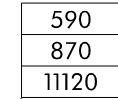
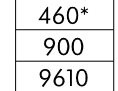

METERED

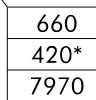
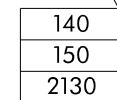
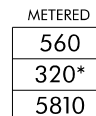

S

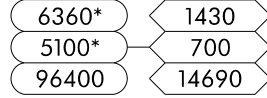
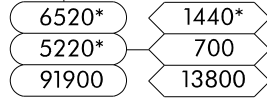

S

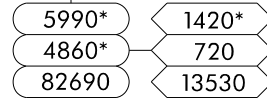
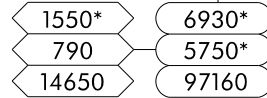

S

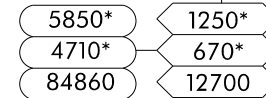

S

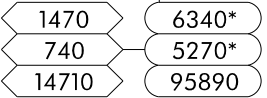

Washington State Department of Transportation



4 OF 31



EXIT 151  
S 200TH ST  
MILITARY RD

EXIT 152  
S 188TH ST  
ORILLIA RD

S 183RD ST

S 178TH ST

4650*	570*
5930*	1520
86350	12700

520*	4500*
1470	5650*
11960	83040

530*	5380*
1480	7000*
11630	97150

5330*	500*
6910*	1320
99240	11160

METERED

280*	310
650	350
4730	5310

METERED

460*	230	460
880	290	470
9840	3990	6160

MILITARY RD

ORILLIA RD

METERED

770
1000
12550

300
300
5010

590
460
7010

550
490
8800

6430*	1460
5330*	740
93280	14280

1470	6210*
630	5150*
13600	94850

1550	7190
650	6280
12930	106450

6660	1360
5730*	580
101960	11850



Washington State  
Department of Transportation



5  
OF  
31

S 172ND ST

EXIT 154A  
KLIICKITAT DR  
SOUTHCENTER PKWY

EXIT 154A/B  
SR 518  
I-405

EXIT 154B  
S 154TH ST  
SOUTHCENTER BLVD



S

5040*	400*
6850*	1180
96620	9400

4370*
6670*
90280

1310*	360*
1640	690
24820	8100

4160*	700*
6340*	1440
95030	15900

METERED

1010*	210*
1270*	530
16800	8170

S

1060
480
9140

850	1070*
830*	1440
15560	19800

710*
970
10570

KLIICKITAT DR

SOUTHCENTER PKWY

S

380*
860
7430

T

990	1600*
970	1250
15890	22250

430
180
2910

930*	1780*
960*	1320*
15880	24490

METERED

530*	30
760	60
9410	660

6740	1260
5770*	540
107090	10720

4540
2990*
64100

7480	1070
5450*	480
118400	9200



S 144TH ST

EXIT 156  
SR 599

EXIT 156  
INTERURBAN  
AVE

S 129TH ST



S

5890*	680*
8200*	1350*
98950	12280

5300*	4480*
7270*	5920*
98370	84930

4470*	590*
5930*	1130*
95180	11620

S

4690*	640*
6280*	1280
87110	12660

580*
1100*
11400

630*
1210*
12210

599

530*
850*
10010

160*
360
3640

230*
440
4390

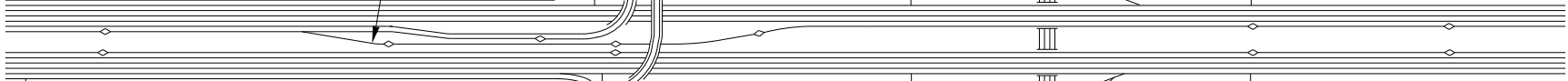

2250
1510
27560

80
80
1190

METERED	370
	370
	5140

S

7720	1010
5950*	590*
108600	10510

5600	1050
4470*	620*
81000	11060

5620	1120
4510*	670*
80790	11770

S

5940	1150
4790*	710*
83090	11860



Washington State  
Department of Transportation



7  
OF  
31

EXIT 157

SR 900  
M L KING JR WAY S

EXIT 158

S BOEING  
ACCESS RD

S NORFOLK ST

S BENEFIT ST

S THISTLE ST

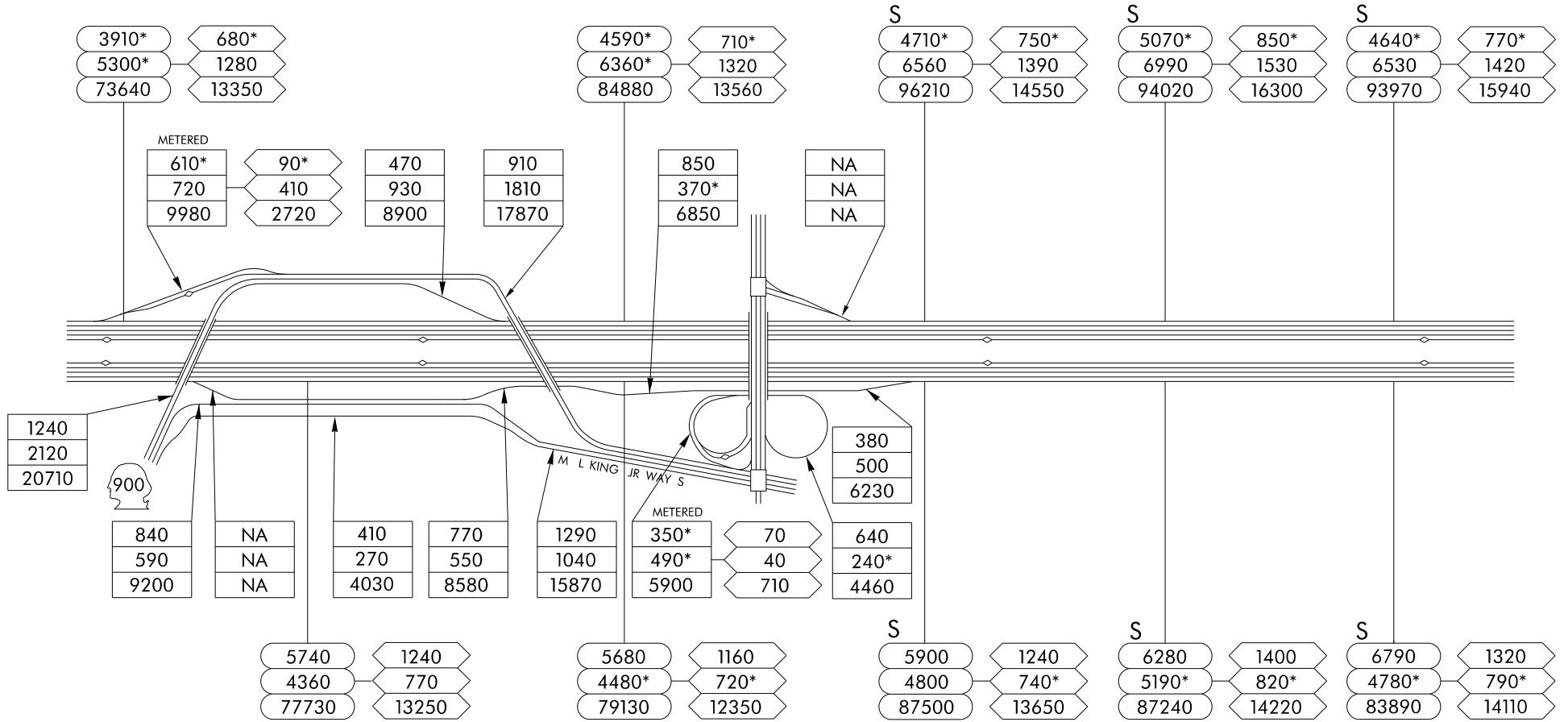



S HOLDEN ST

S HOLLY ST

EXIT 161  
ALBRO PL  
SWIFT AVE S

EXIT 162  
CORSON AVE S  
S MICHIGAN ST

S PEARL ST

S OREGON ST

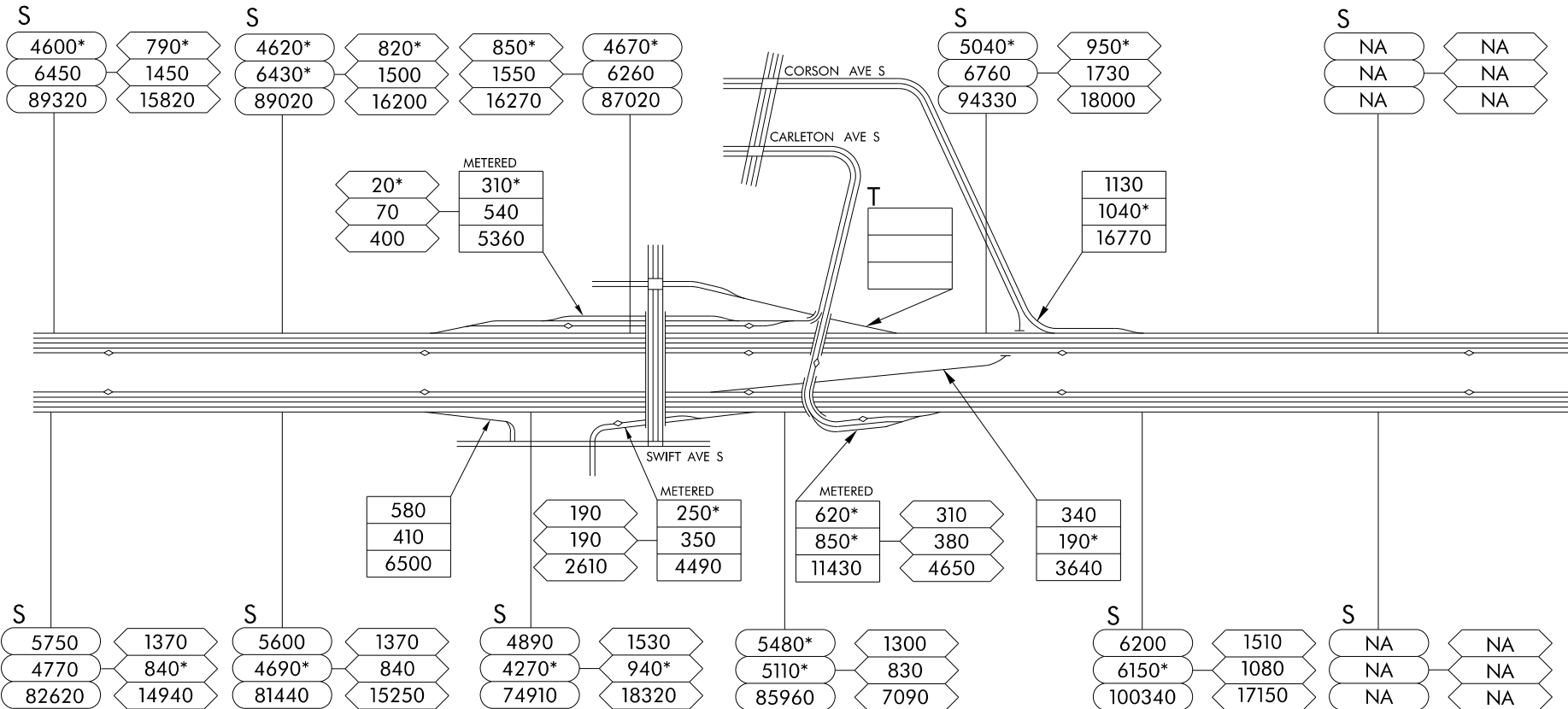

EXIT 163/163A

EXIT 163B

S SPOKANE ST  
COLUMBIAN WY  
WEST SEATTLE BRIDGE

S FOREST ST

S HOLGATE ST

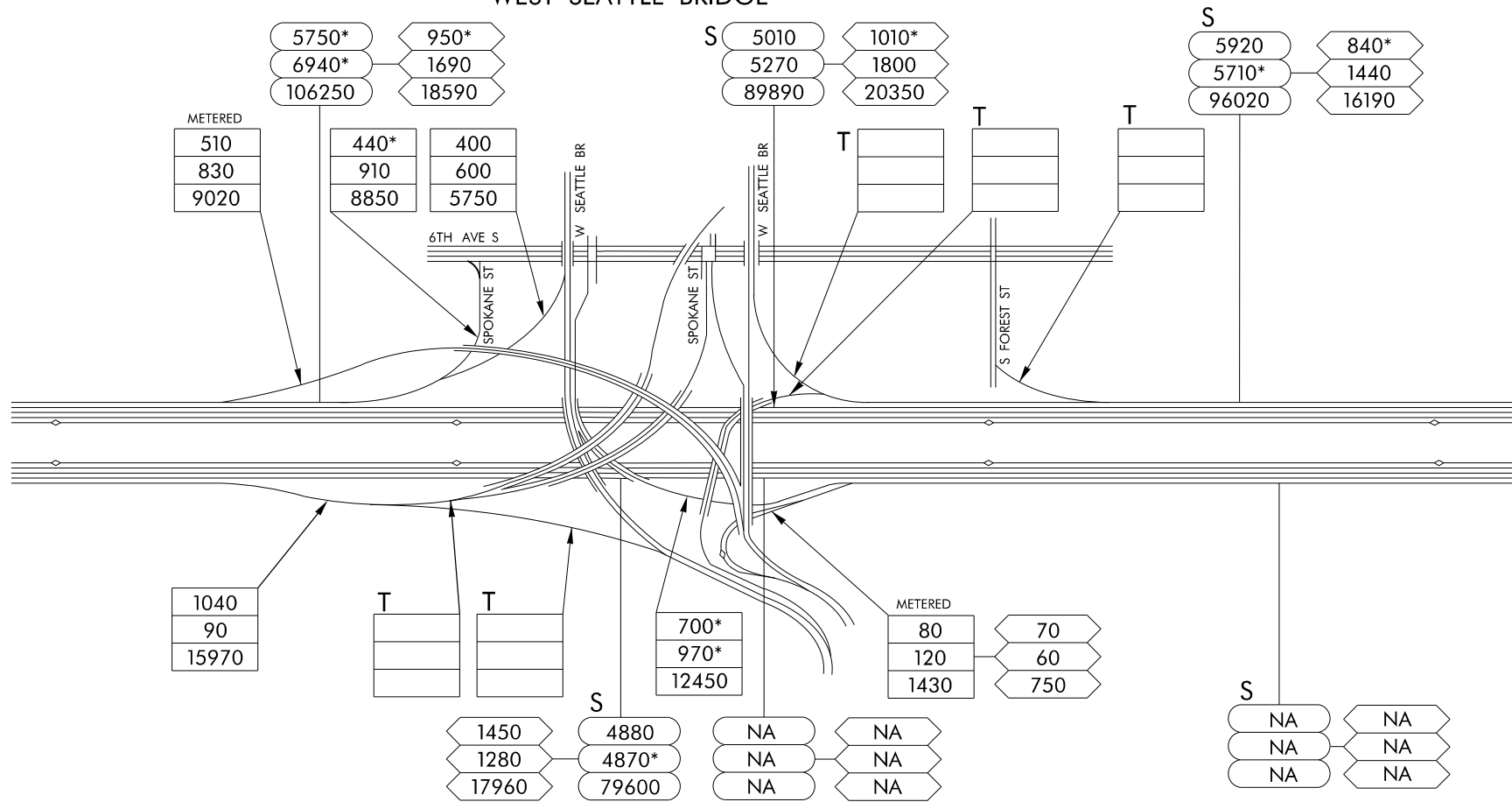

EXIT 164A  
COLLECTOR-DISTRIBUTOR

EXIT 164B  
4TH AVE S DEARBORN ST

YESLER WAY JAMES ST

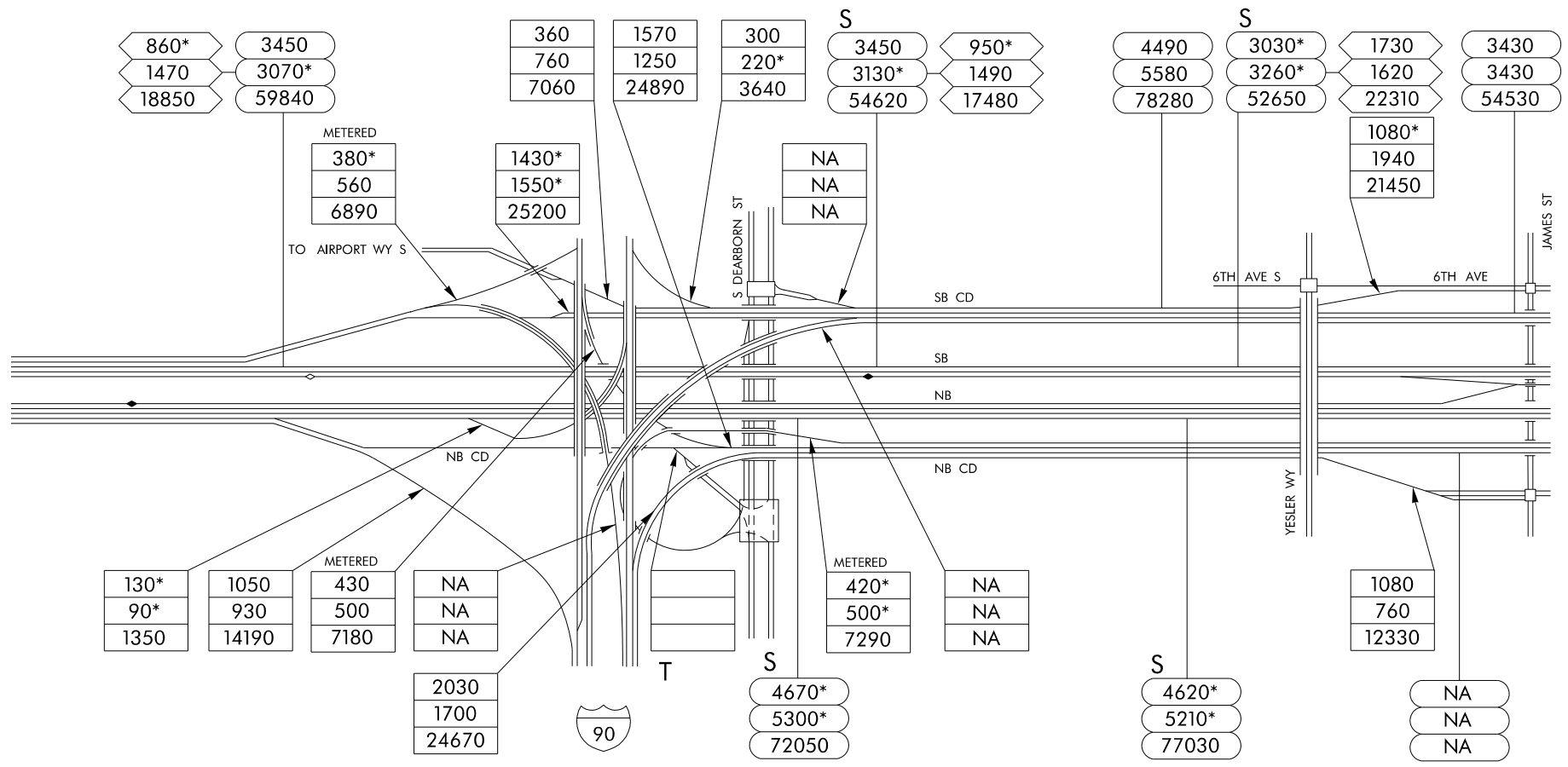

\* es16466\_MMN\_Stn includes only lanes 1 and 2 for metering purposes.  
\*\_MN\_Stn includes only lanes 3 and 4.

CHERRY ST

MADISON ST

UNIVERSITY ST

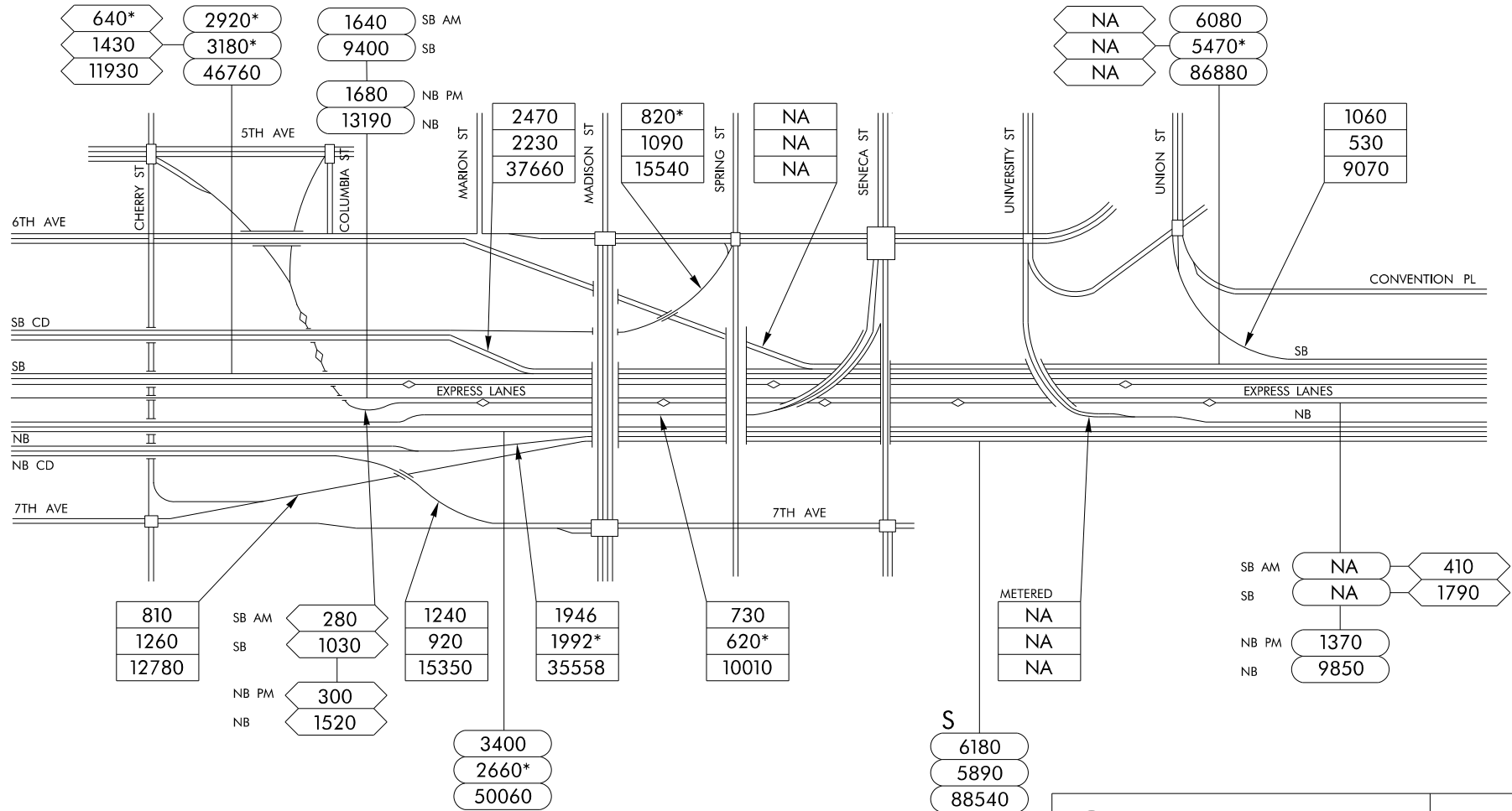

Washington State Department of Transportation



EXIT 166  
STEWART ST

EXIT 167  
MERCER ST

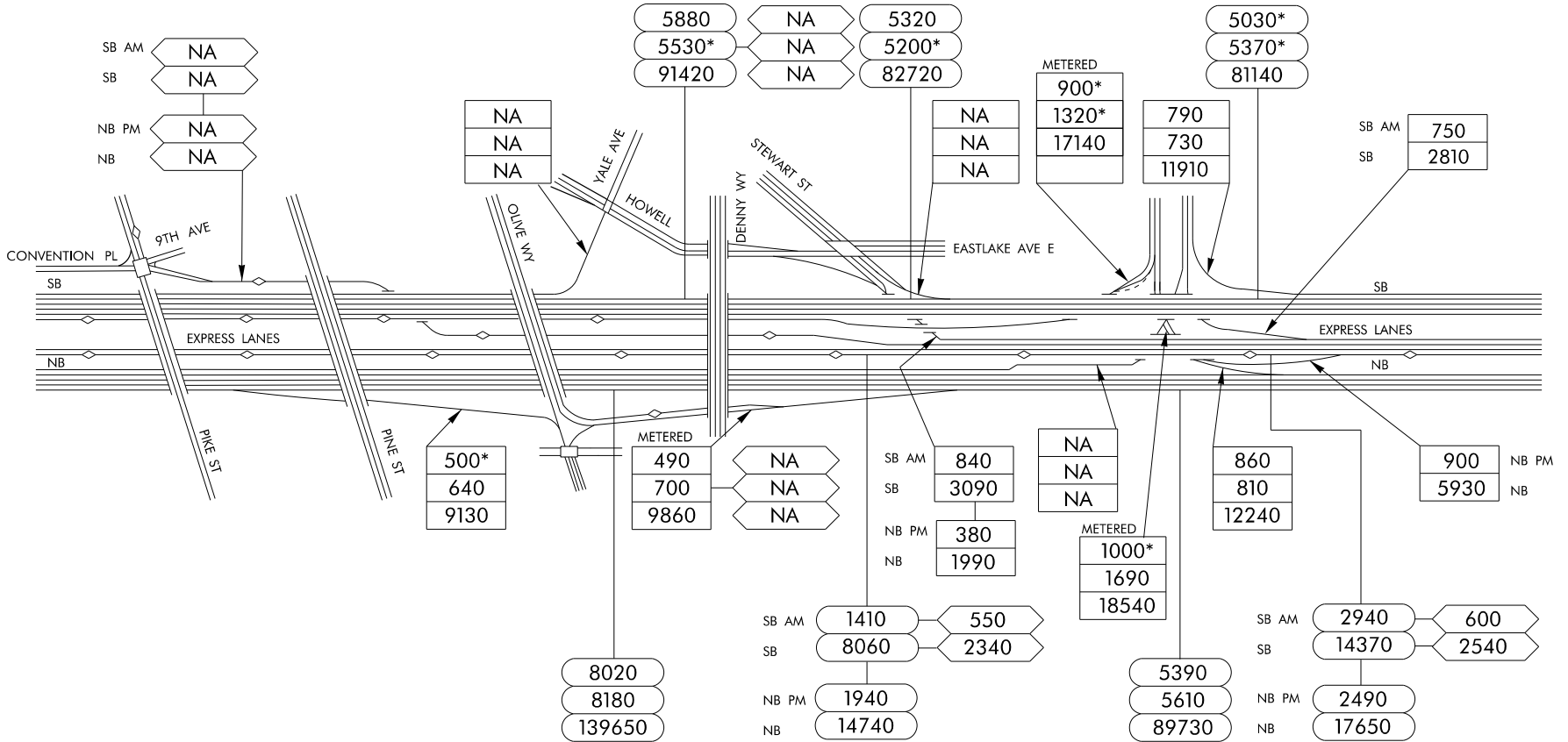



E GALER ST

EXIT 168A  
BOYLSTON AVE  
LAKEVIEW BLVD

EXIT 168B  
ROANOKE ST  
SR 520

EXIT 168A  
HARVARD AVE  
ROANOKE ST

SHIP CANAL  
BRIDGE

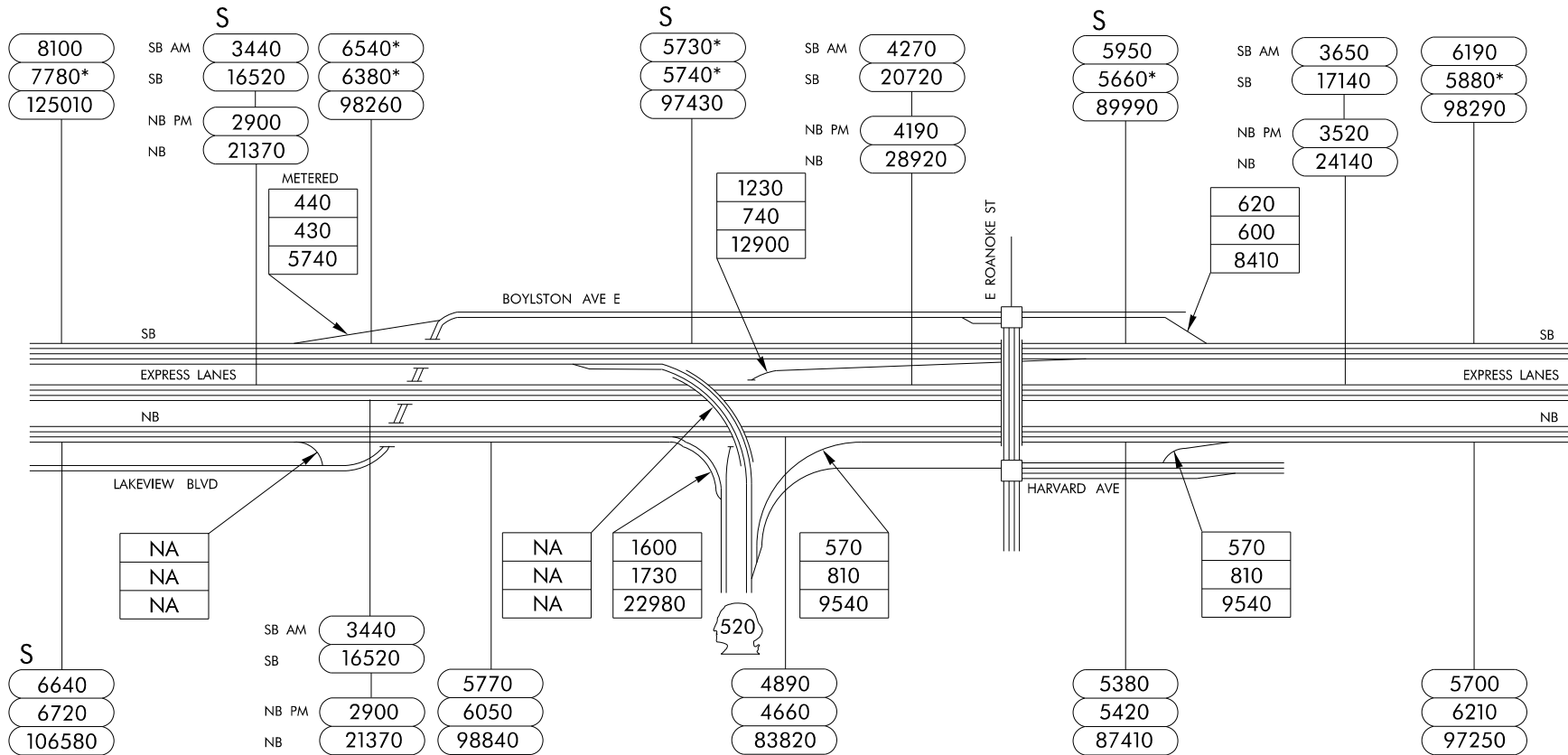



NE 42ND ST

EXIT 169  
NE 45TH ST  
NE 50TH ST

RAVENNA BLVD

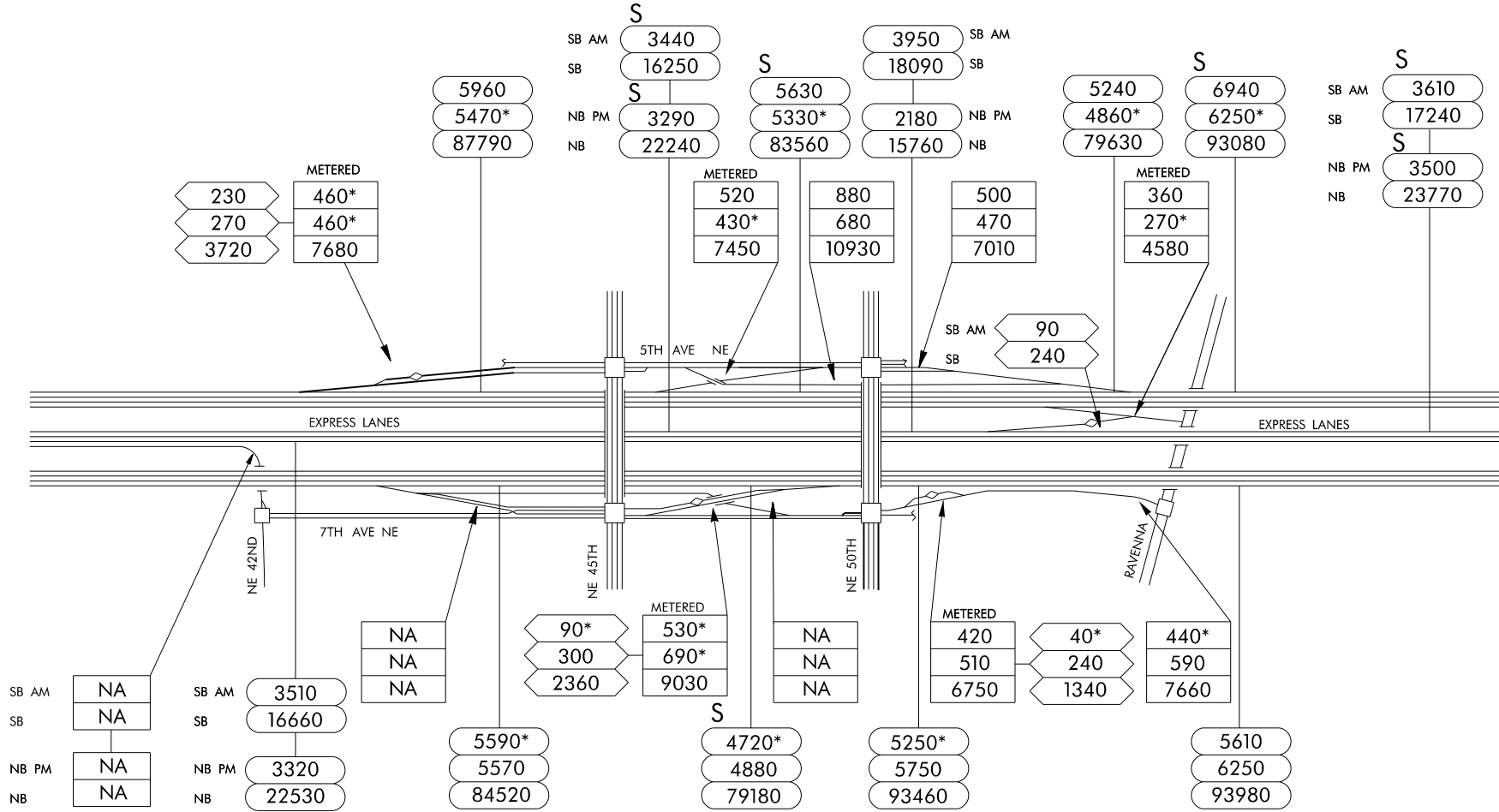

**EXIT 171**  
NE 70TH ST  
LAKE CITY WY

**EXIT 172**  
NE 80TH ST  
NE 85TH ST

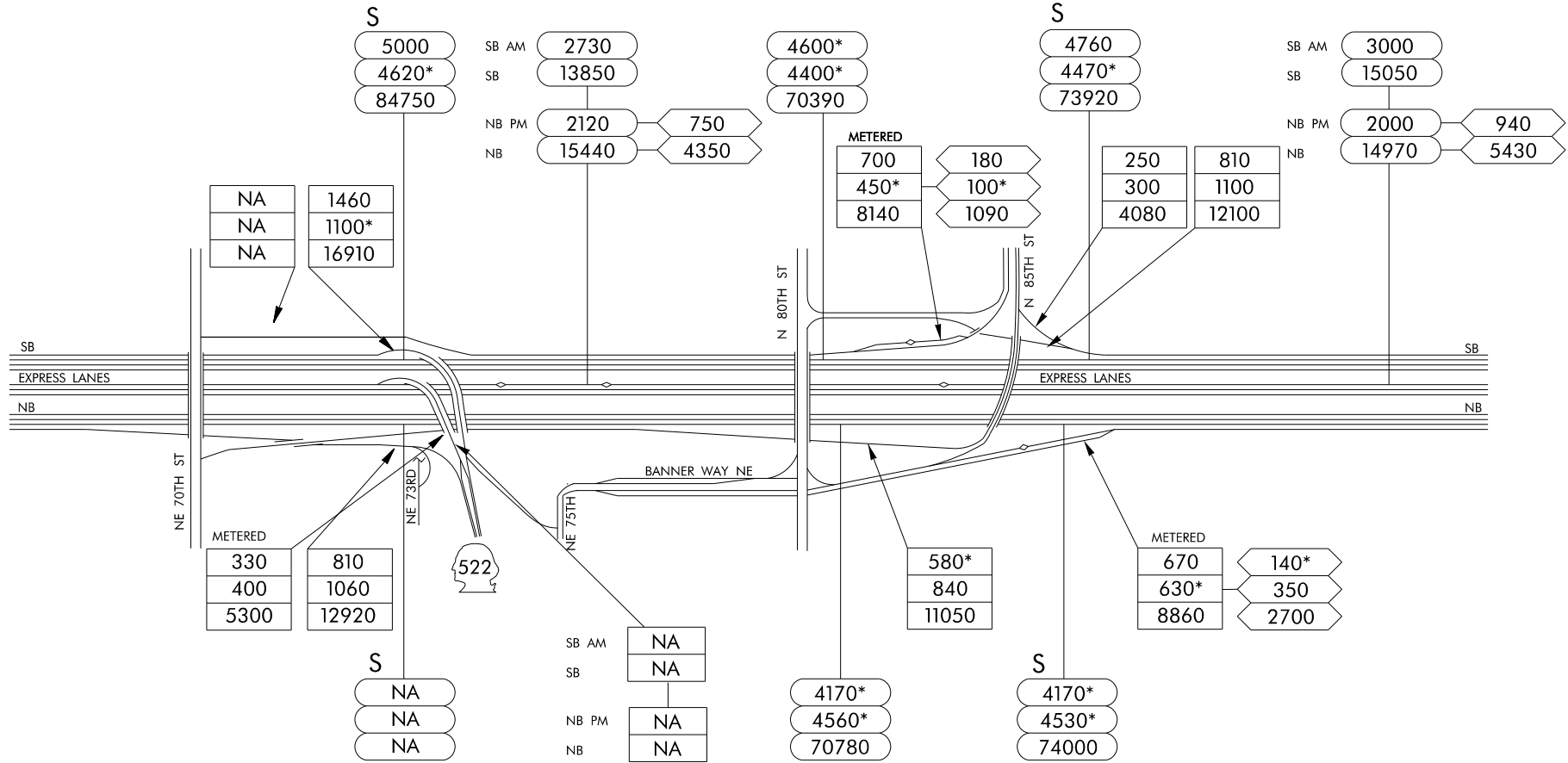

NE 92ND ST



EXIT 173

NE NORTHGATE WY

NE 120TH ST

EXIT 174

NE 130TH ST

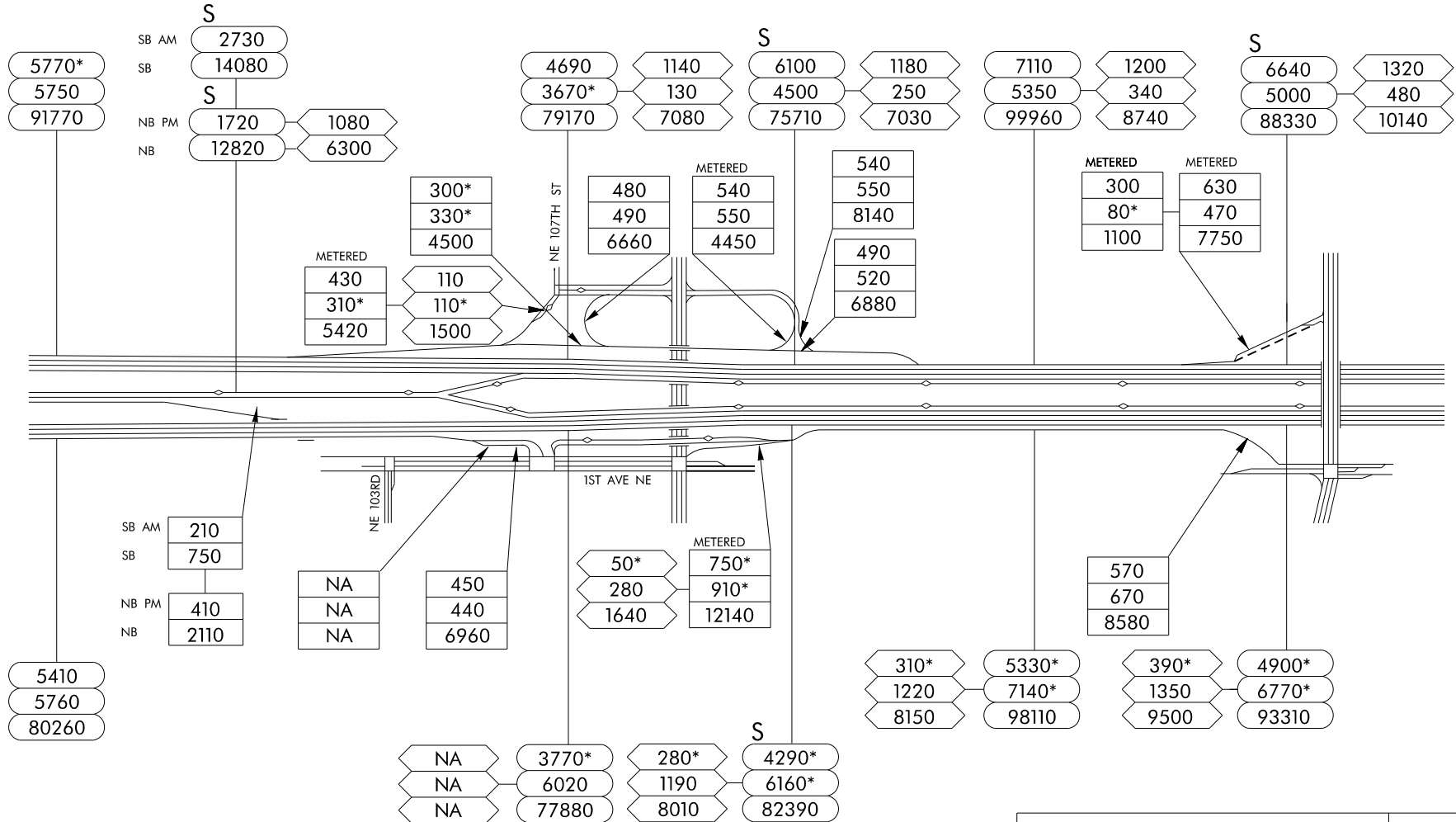

Washington State Department of Transportation



17 OF 31

EXIT 175

EXIT 176

NE 137TH ST

SR 523  
NE 145TH ST

NE 155TH ST

METRO  
NORTH BASE

NE 175TH ST

8120	1310
5870	580
98720	10530

S

5100	1370
3960	680
79560	13880

5470	1440
4650	770
80730	13610

S

5710	1530
4960	820
81520	13830

1420	5000	1470	5290
800	4280	810	4740
13770	73710	13670	78420

METERED

510
450
7200

1260
620
12180

523

460*	5
910	4*
11450	60

METRO ONLY

40*
30*
370

METRO ONLY

40*
40*
390

300
90
2090

390*
520
6480

5TH AVE NE

650
950
11590

S

5	370*
4*	1320
50	9460

METERED

480*
550*
7080

60*	230
1700	

METRO ONLY

30
30
400

METRO ONLY

NA
NA
NA

EXIT TO  
NE 175TH  
ONLY

480*
760
9320

METERED

460
630*
7170

30*
250
1300

4750*	NA
6310*	NA
91070	NA

4110*	370*
5440*	1320
74200	9460

4680*	370*
6050	1350
85040	9860

S

4870*	400*
6240*	1490
90370	10310

NA	NA
NA	NA
NA	NA



Washington State  
Department of Transportation



18  
OF  
31

NE 195TH ST

EXIT 177  
SR 104  
NE 205TH ST



EXIT 178  
236TH ST SW

228TH ST SW 220TH ST SW

EXIT 179

213TH ST SW

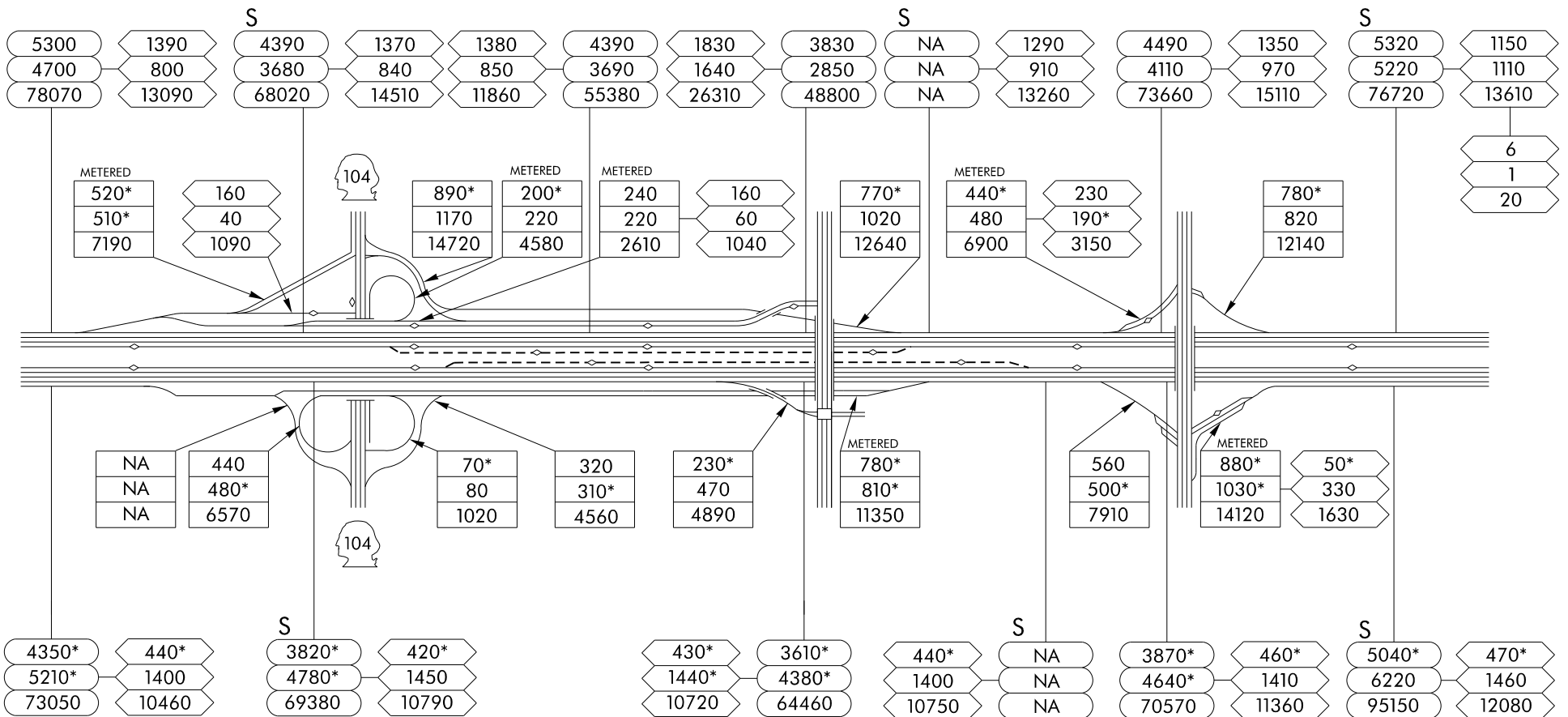

208TH ST SW

LYNNWOOD  
PARK & RIDE  
DIRECT ACCESS

EXIT 181A

44TH AVE W

EXIT 181/181B

ALDERWOOD MALL PKWY  
196TH ST SW

28TH AVE W

EXIT 182

I-405  
SR 525

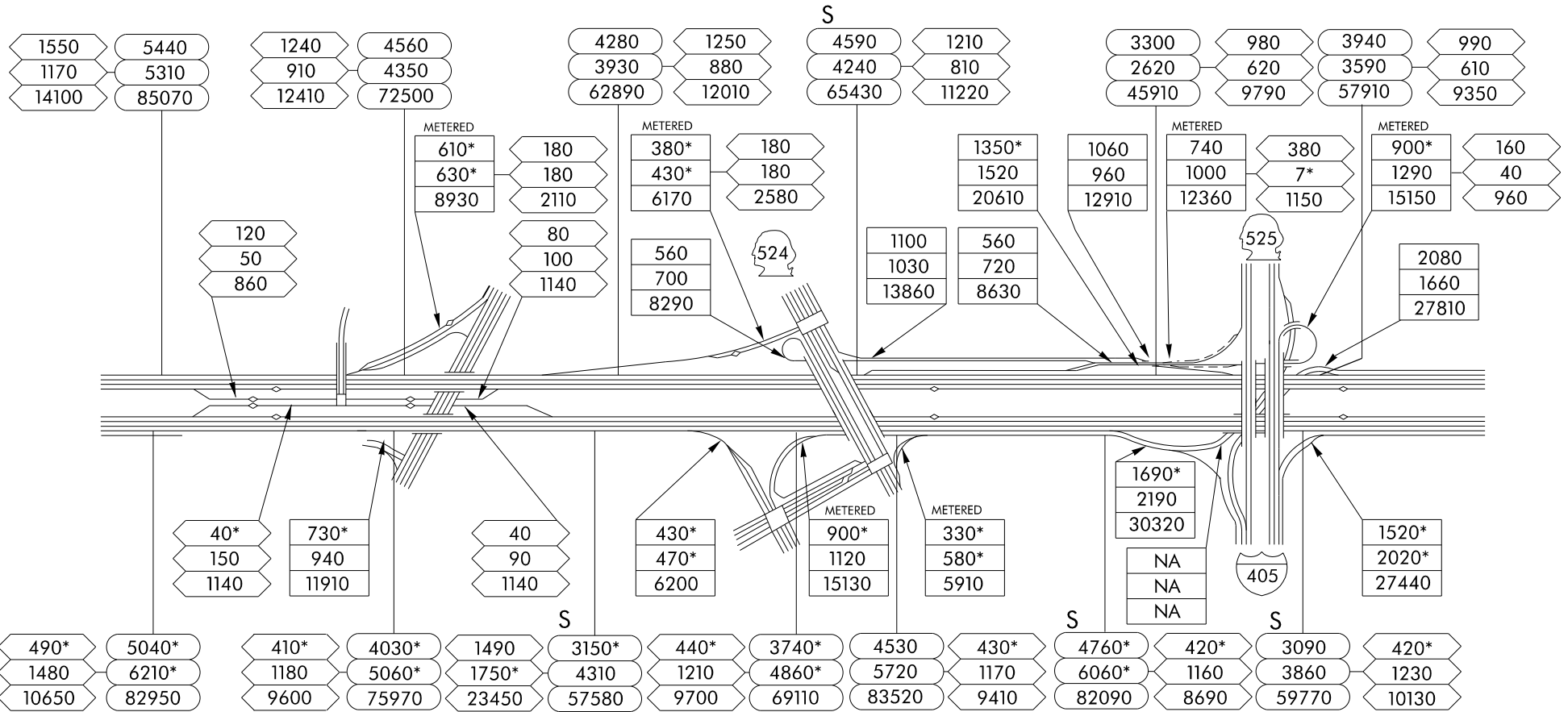

EXIT 183



175TH ST SW

164TH ST SW

ASHWAY  
PARK & RIDE  
DIRECT ACCESS

156TH ST SW

148TH ST SW

140TH ST SW

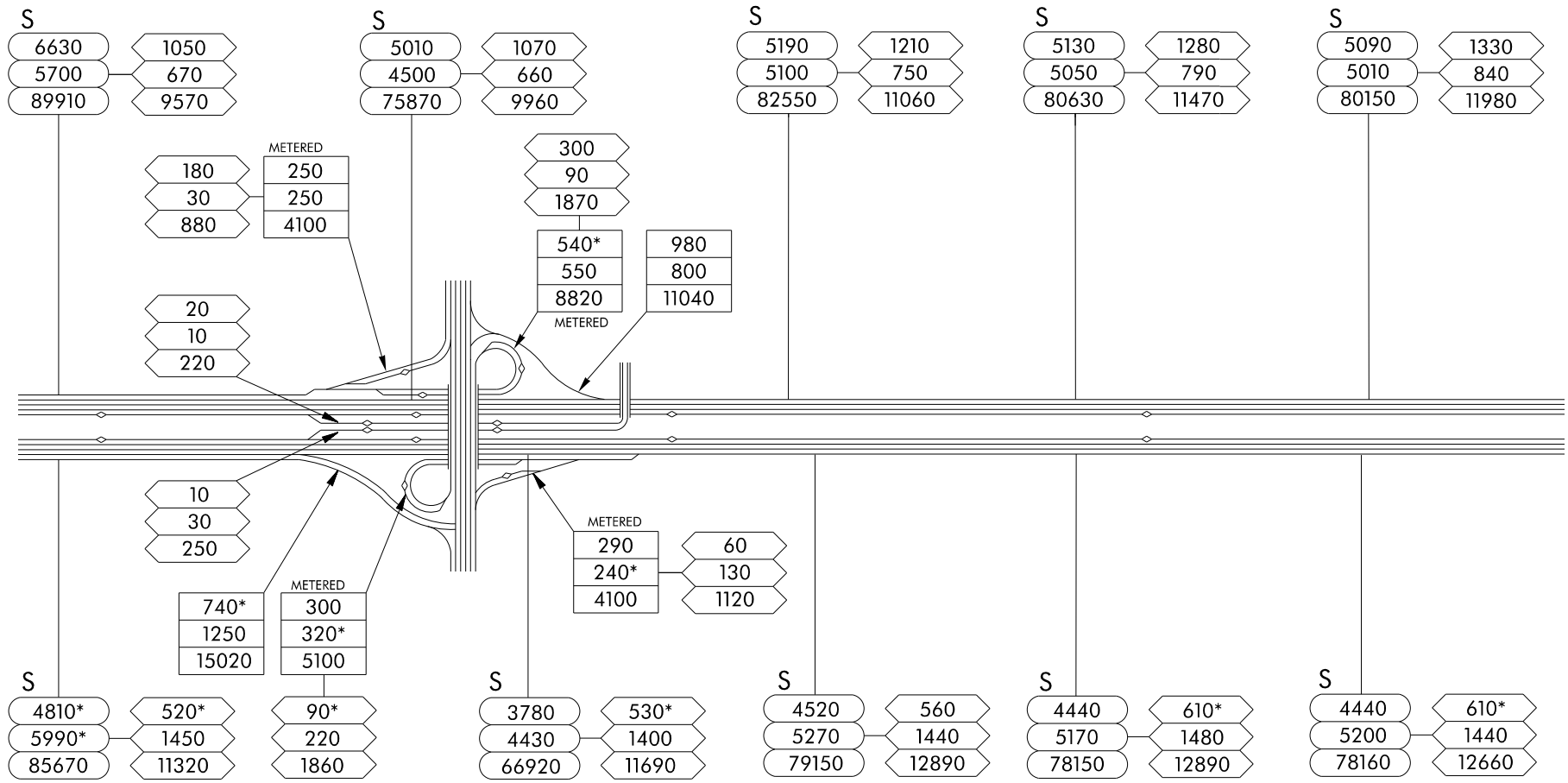

EXIT 186

SR 96



134TH ST SW

128TH ST SW

122ND ST SE

118TH ST SE

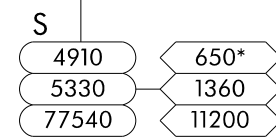
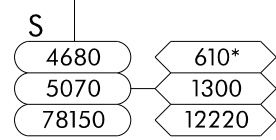
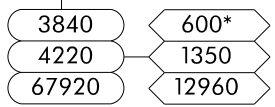
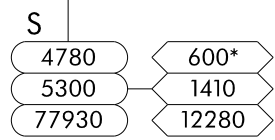
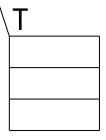
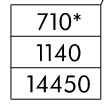
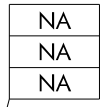
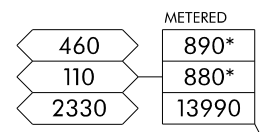
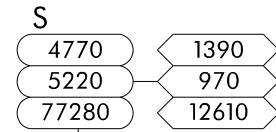
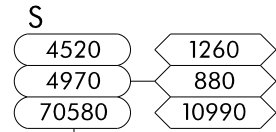
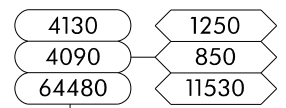
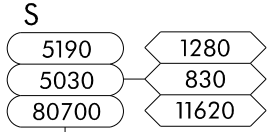



112TH ST SE  
PARK & RIDE

106TH ST SE

EVERETT MALL  
WAY

EXIT 189

SR 526  
SR 99, SR 527



77TH ST SE

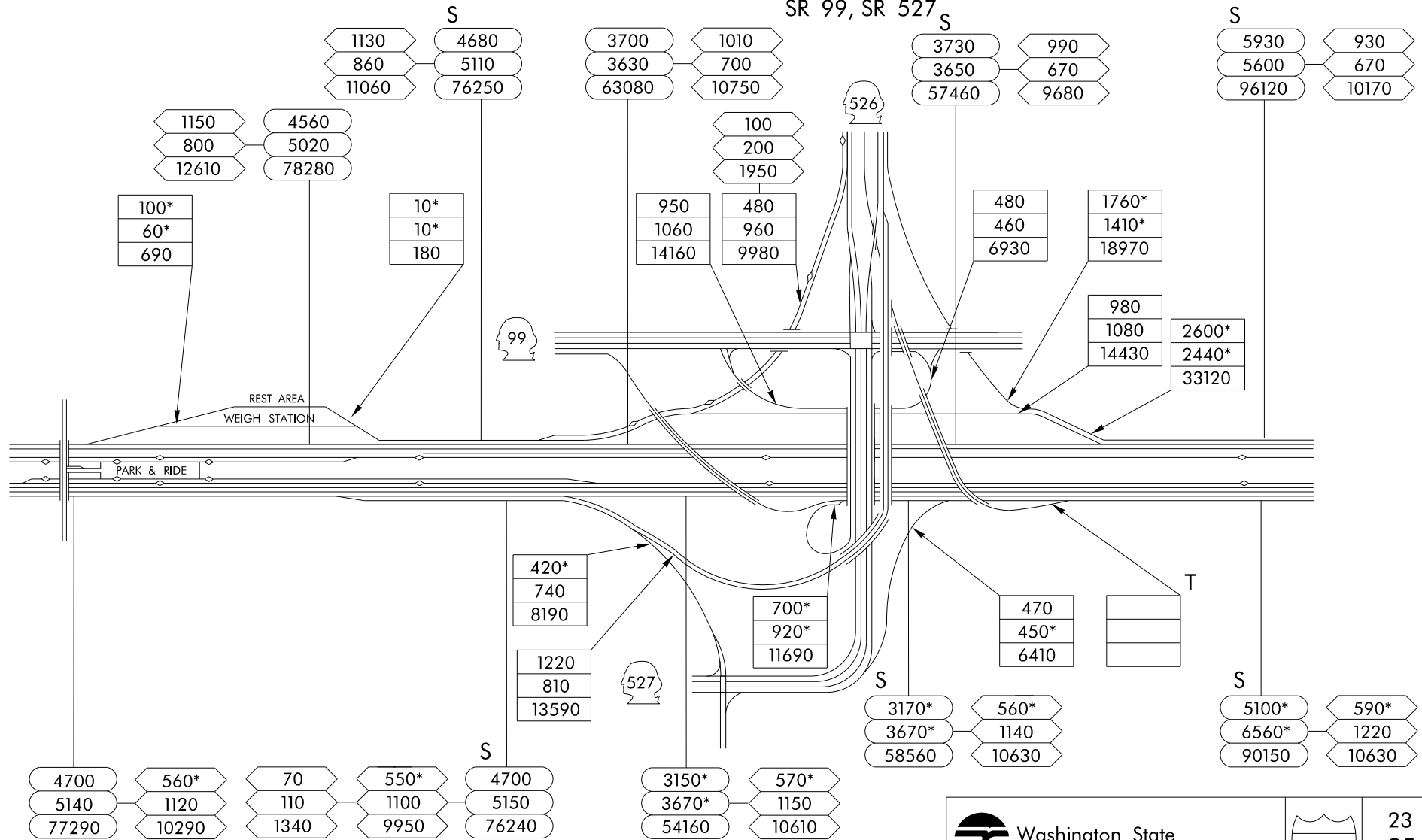

Washington State  
Department of Transportation



23  
OF  
31

73RD ST SE

S

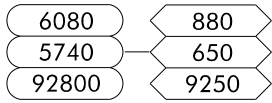

LEXINGTON AVE SE

S

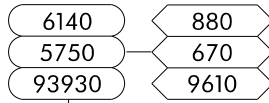

LINCOLN ST



S

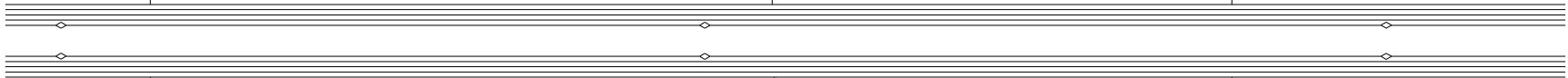
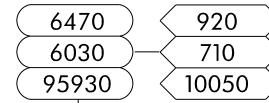

S

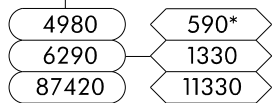

S

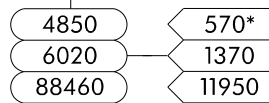

S

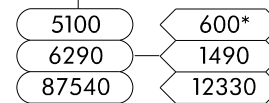

Washington State  
Department of Transportation



24  
OF  
31



49TH ST SE

EXIT 192  
41ST ST SE

36TH ST SE

EXIT 193  
PACIFIC AVE

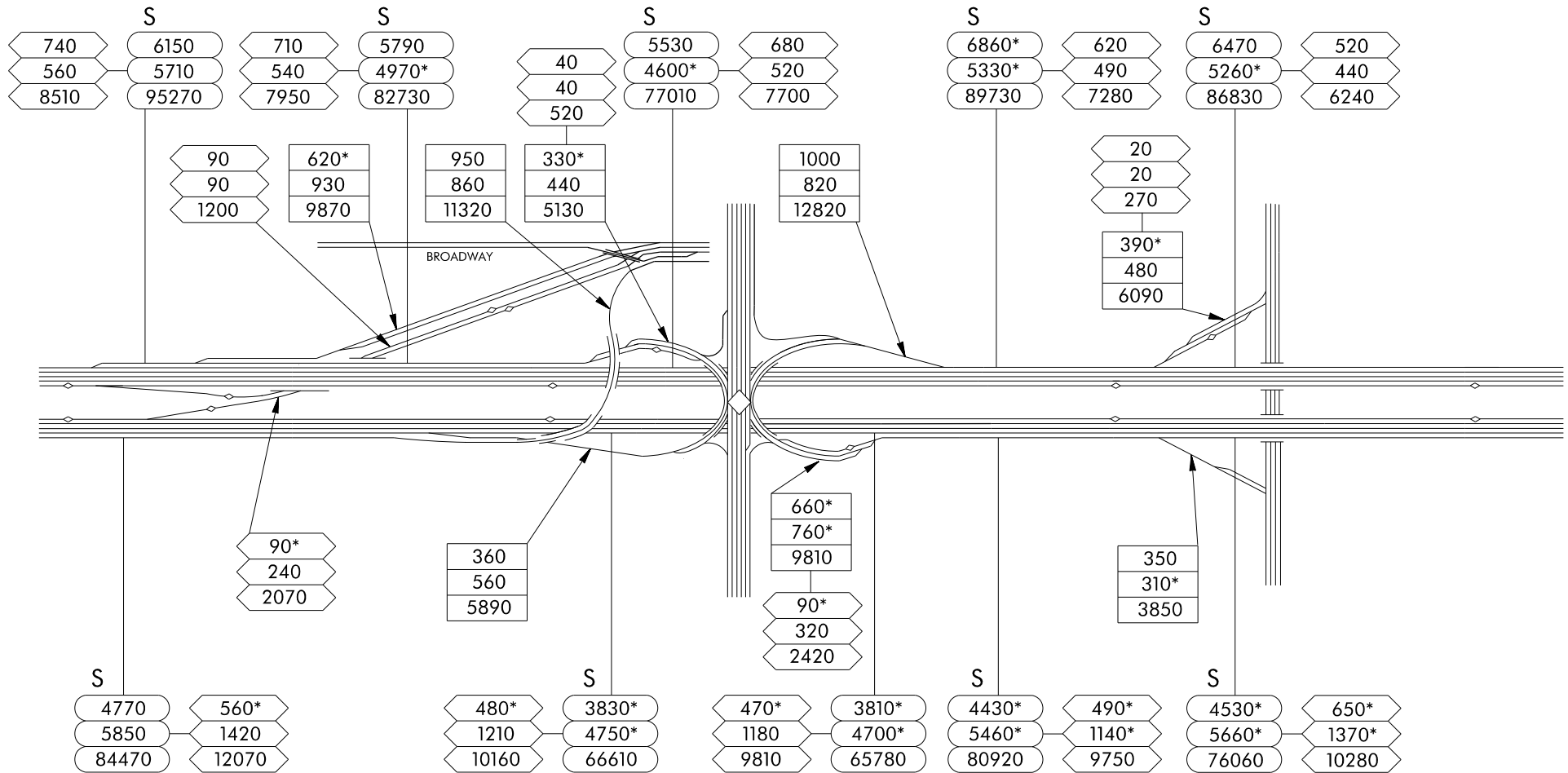



EXIT 194  
US 2  
EVERETT AVE

EXIT 195  
MARINE VIEW DR

490  
420  
6320

4270  
3520\*  
61930

4320  
3550\*  
60040

460  
390  
5680

60  
70  
910

4620  
3920\*  
67210

380  
320  
4690

1900\*  
1490\*  
25080

HEWITT AVE  
CALIFORNIA ST

WALNUT ST

1000  
1060\*  
13970

800  
860  
11050

1120\*  
1700\*  
22160

2

520  
520\*  
7760

260\*  
460  
4350

3530\*  
4680\*  
61490

730  
610\*  
9480

3840\*  
4980\*  
63840

620\*  
1350\*  
12190

2920\*  
3360\*  
56320

EXIT 198

SR 529

EXIT 199

SR 528  
4TH ST

70TH ST NE



79TH ST NE

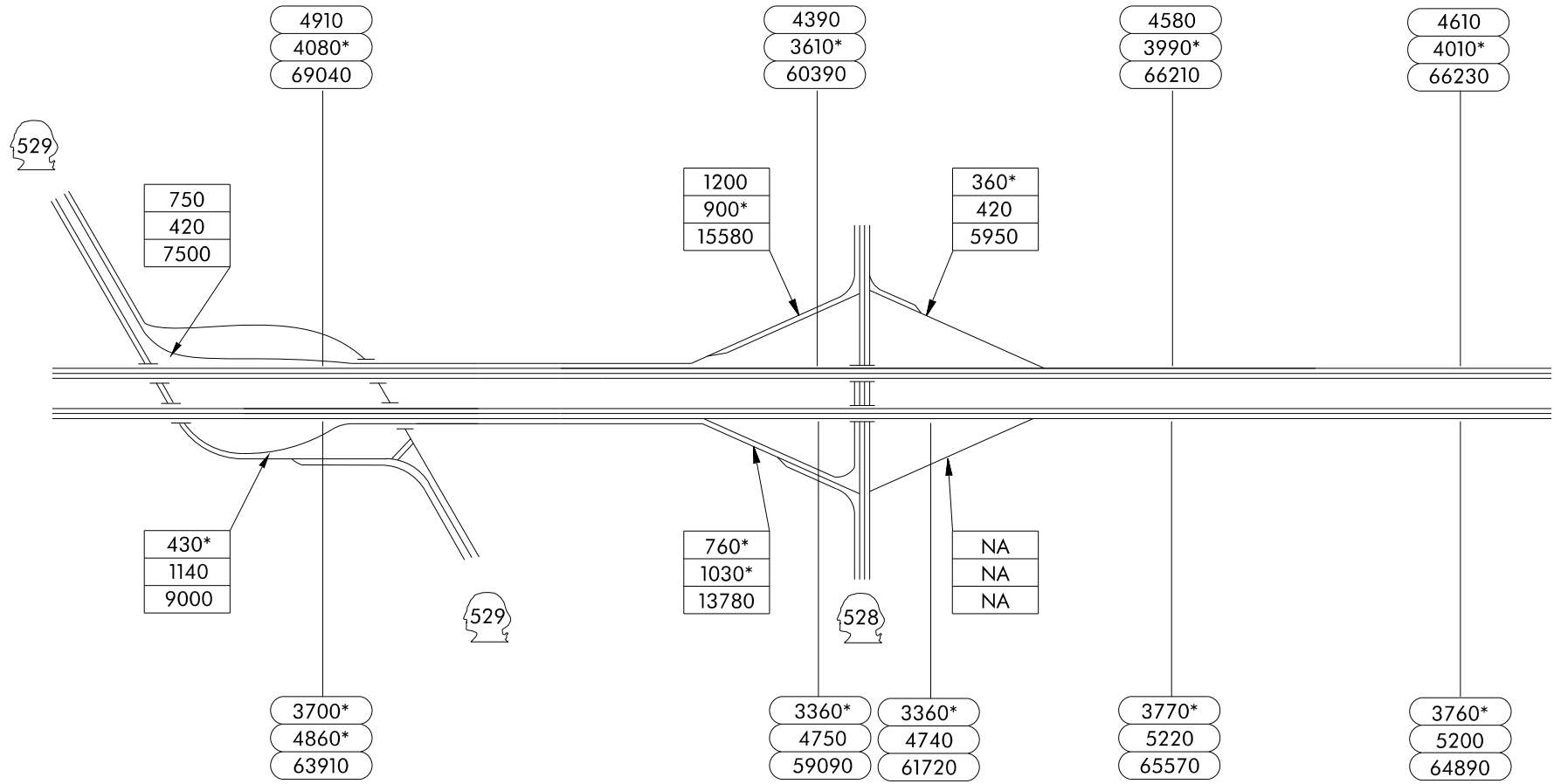

Washington State  
Department of Transportation



27  
OF  
31

EXIT 200

88TH ST NE  
QUIL CEDA WAY

98TH ST NE

105TH ST NE

EXIT 202

116TH ST NE

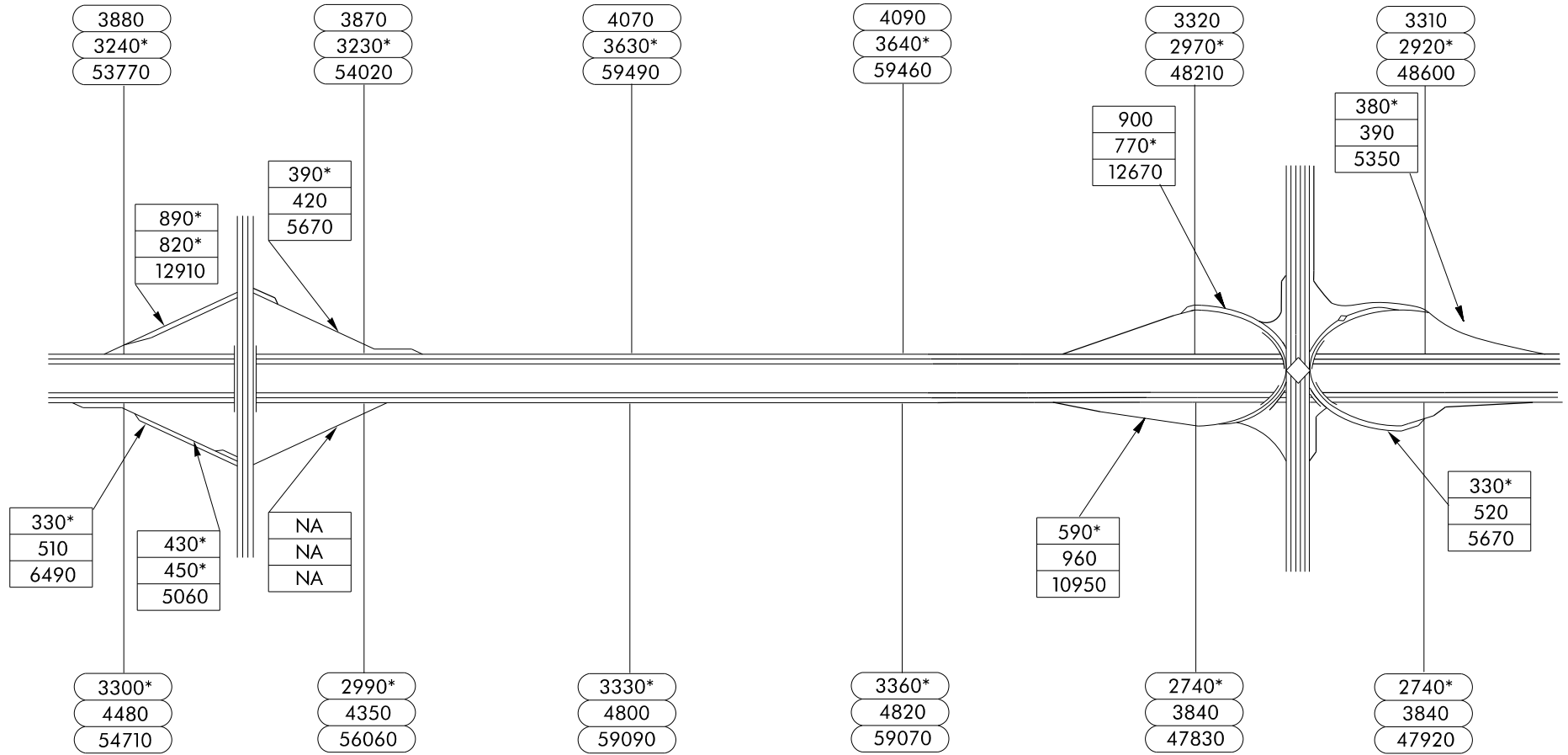

Washington State  
Department of Transportation



28  
OF  
31



127TH ST NE

136TH ST NE

144TH ST NE

152ND ST NE

160TH ST NE

3540  
3300\*  
53500

3540  
3300\*  
53330

3460  
3230\*  
52850

3540  
3300\*  
52900

3640  
3390\*  
54090

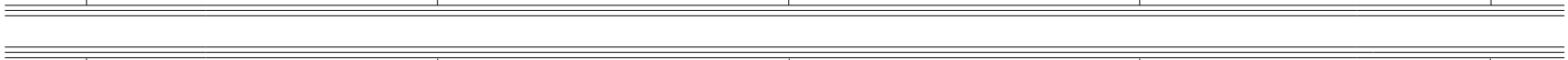

3080\*  
4380  
53500

3050\*  
4360  
53840

3110\*  
4440  
54440

3120\*  
4420  
54550

3110\*  
4460  
49120



Washington State  
Department of Transportation



29  
OF  
31

EXIT 206

SR 531  
172ND ST NE  
(SMOKEY PT)

180TH ST NE

189TH PL NE

200TH ST NE



2580  
2300\*  
38110

NA  
NA  
NA

7\*  
9  
110

460\*  
520\*  
7310



90  
70  
1070

600  
530  
7980

540\*  
560  
7980

2940  
2780\*  
45460

80\*  
70\*  
900

2970  
2760  
44570

REST AREA

2990  
2820\*  
45320

970\*  
1310\*  
16480



530\*  
770  
8420

110\*  
110\*  
1360

REST AREA

2070\*  
3070  
36910

2610\*  
3850  
45300

2480\*  
3750  
44540

2590\*  
3840  
45210



Washington State  
Department of Transportation



30  
OF  
31



204TH ST NE

EXIT 208  
SR 530  
PIONEER HWY

STILLAGUAMISH  
RIVER

236TH ST NE



3000  
2830\*  
45800

2490  
2410  
38420

2460  
2400  
38310

2860  
2820  
43470

2540  
2490  
38840

530  
520  
470\*  
7560  
370  
380  
5050

290  
290  
4710

450\*  
620\*  
7480

340  
500  
5200

270\*  
450  
4970

2600\*  
3830  
45190

2140\*  
3230  
37620

2130\*  
3210  
37830

2450\*  
3780  
43040

2140\*  
3250  
37160



Washington State  
Department of Transportation



31  
OF  
31



EXIT 2B\2C

I-5

S NORMAN ST

S

4400
4170
51150

1860
1890
26710

300
220*
3640

2030
1700
24670

NA
NA
NA

METERED

430
500
7180

S DEARBORN ST

850
780
9720

S ATLANTIC ST

2030
2480
27280

METERED

380*
560
6890

1200
1580
17130

NA
NA
NA

130*
90*
1350

1050
930
14190

S

4170
4830
60740



Washington State  
Department of Transportation



1  
OF  
11

EXIT 3A\ 3B  
RAINIER AVE S

23RD AVE S

35TH AVE S

WEST HIGHRISE  
S

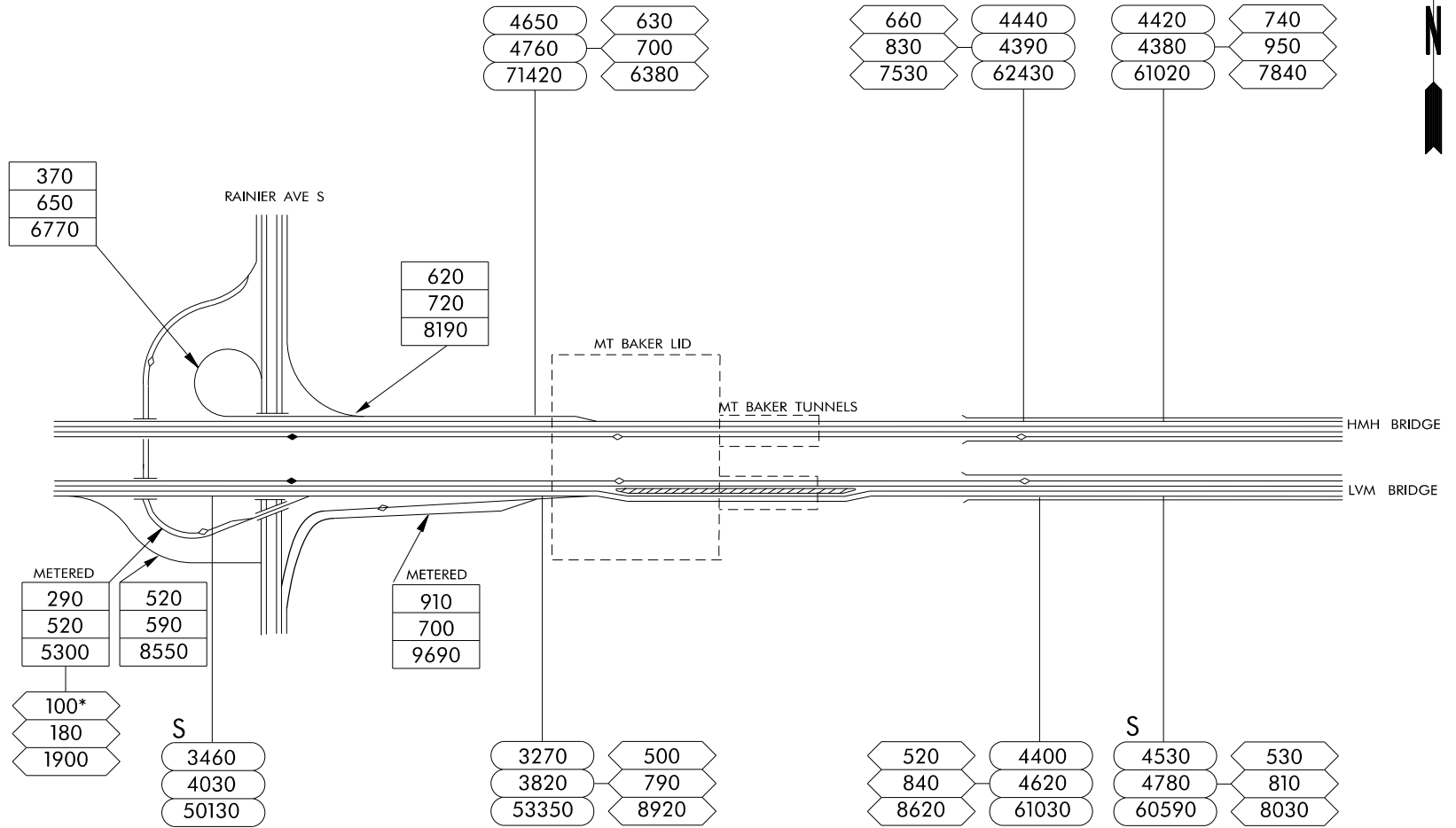

Washington State  
Department of Transportation

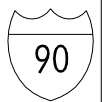

2  
OF  
11



MIDSPAN

EAST HIGHRISE

EXIT 6A  
W MERCER WY

76TH AVE SE

77TH AVE SE

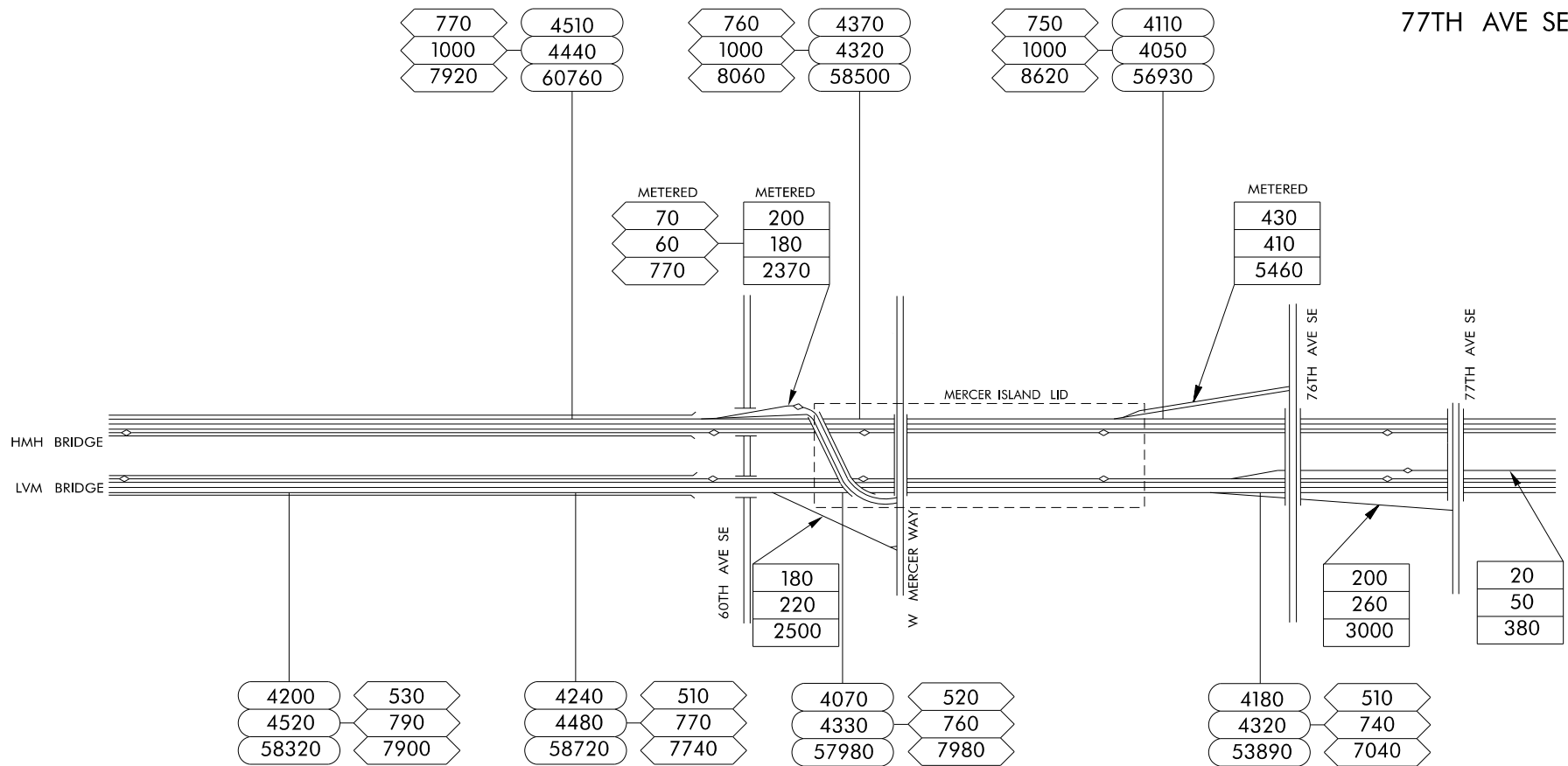

Washington State  
Department of Transportation

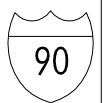

3  
OF  
11



EXIT 7\7B  
ISL CREST WY

SHOREWOOD  
DRIVE

EXIT 8  
E MERCER WY

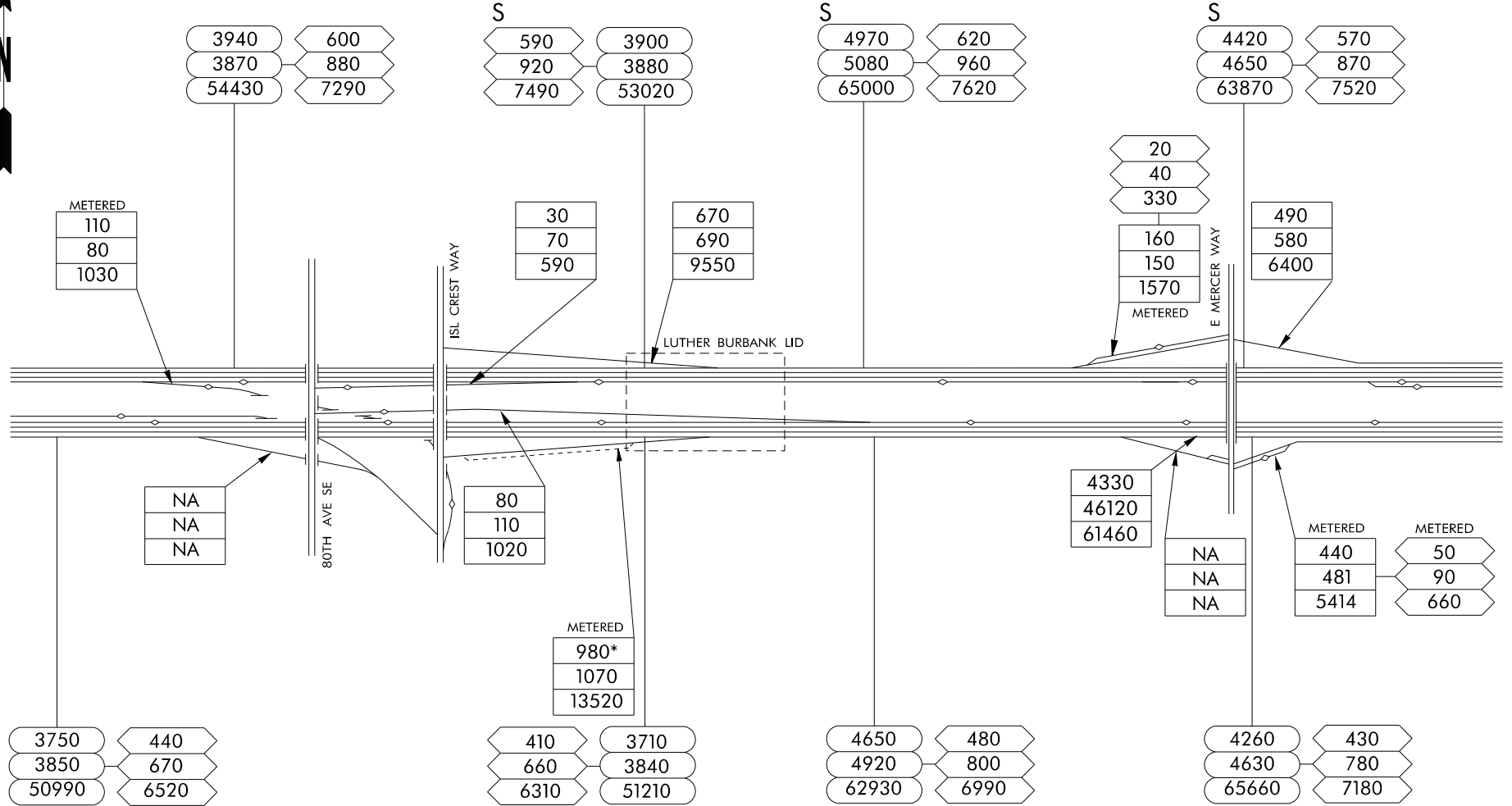



EXIT 9

EXIT 10\10B

EXIT 10B

E CHANNEL BRIDGE

BELLEVUE WY 118TH AVE SE

RICHARDS RD 132ND AVE SE

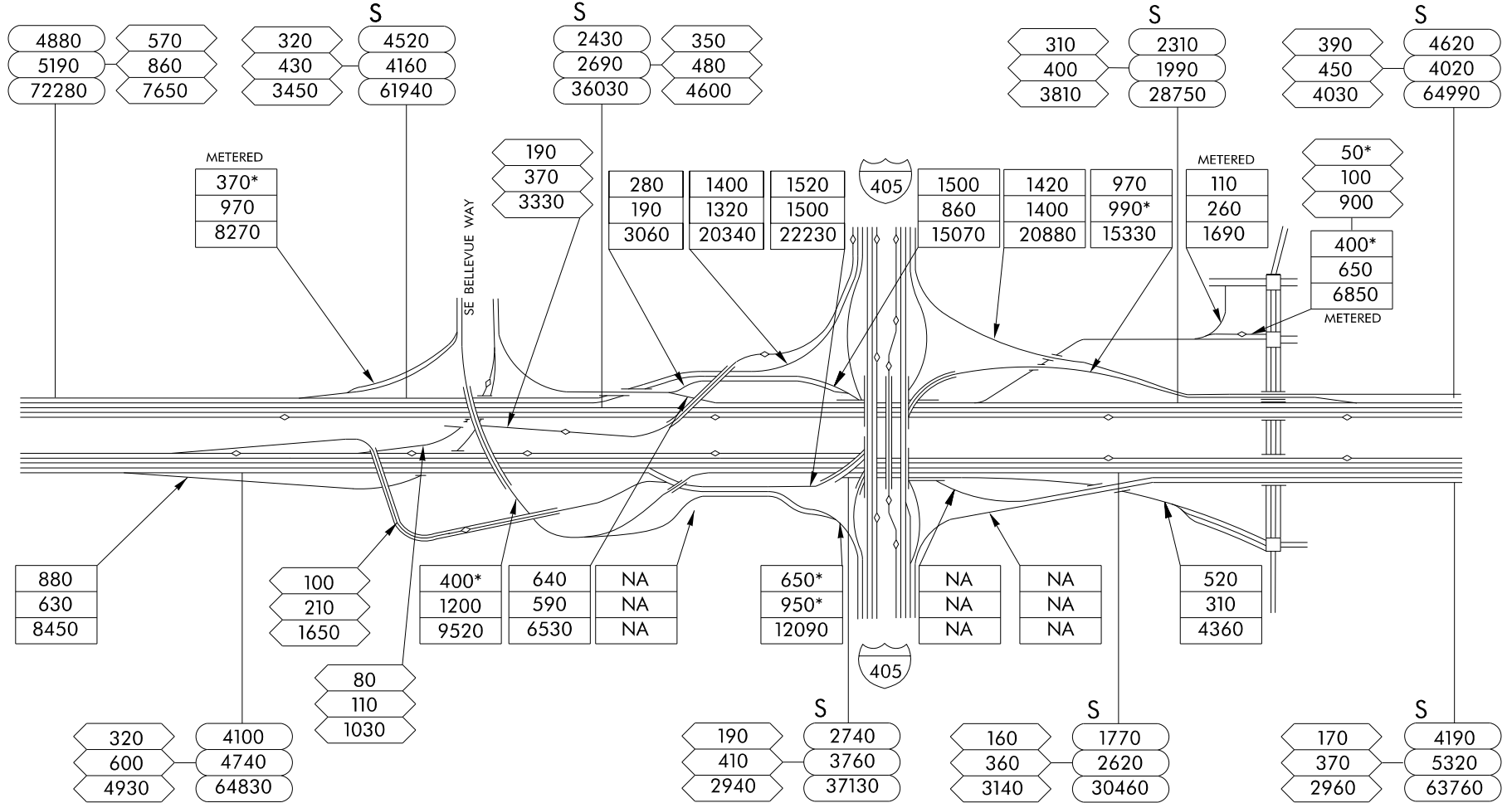

Washington State Department of Transportation

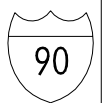

5 OF 11

142ND PL SE  
PARK & RIDE  
DIRECT ACCESS

EXIT 11A\B  
148TH AVE SE  
150TH AVE SE

EXIT 11  
161ST AVE SE  
S

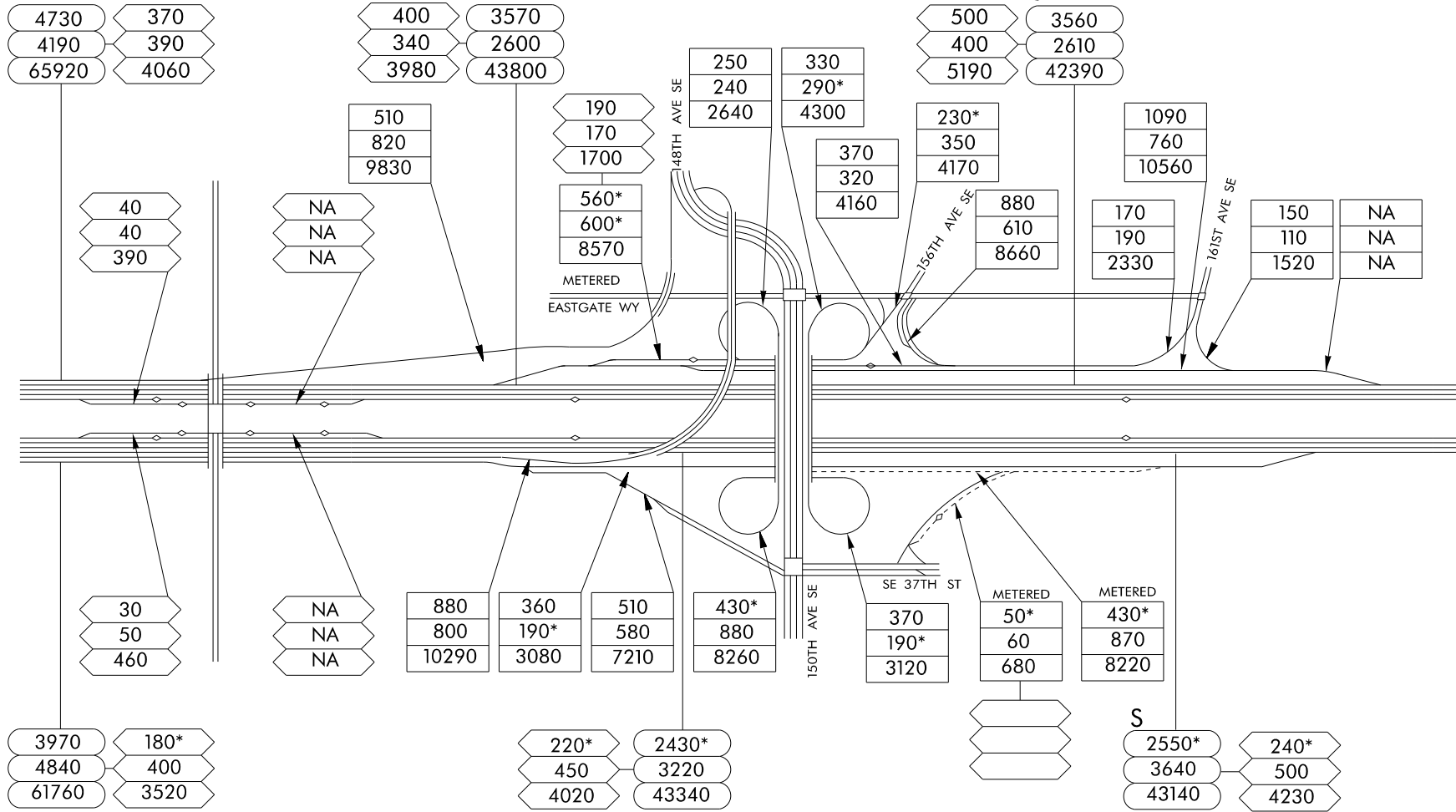



164TH AVE SE

4650 590  
3650 430  
53500 5340

169TH AVE SE

NA 2420  
NA 2690  
NA 36020

EXIT 13  
W LAKE SAMMAMISH PKWY  
NEWPORT WAY

580 3580  
470 2920  
6470 46340

S

3780 660  
3080 510  
46110 6760

193RD AVE SE

4020 620  
3490 530  
52670 6920

720  
420  
6490  
METERED

390  
540  
5480

380  
670  
6480

400  
540  
5670

S

4190\* 240\*  
5720 530  
78360 4490

230\* 3230\*  
510 4740  
4410 56070

240\* 2830\*  
460 4050  
4190 47870

3010\* 320\*  
4370 530  
51300 5210

3120\* 330\*  
4690 640  
60630 5670



Washington State  
Department of Transportation



7  
OF  
11





200TH AVE SE

EXIT 15  
SR 900  
RENTON-  
ISSAQUAH RD SE

12TH AVE NW

EXIT 17  
FRONT ST  
& E LAKE SAMM

EXIT 18  
E SUNSET WY  
& HIGHLANDS DR NE

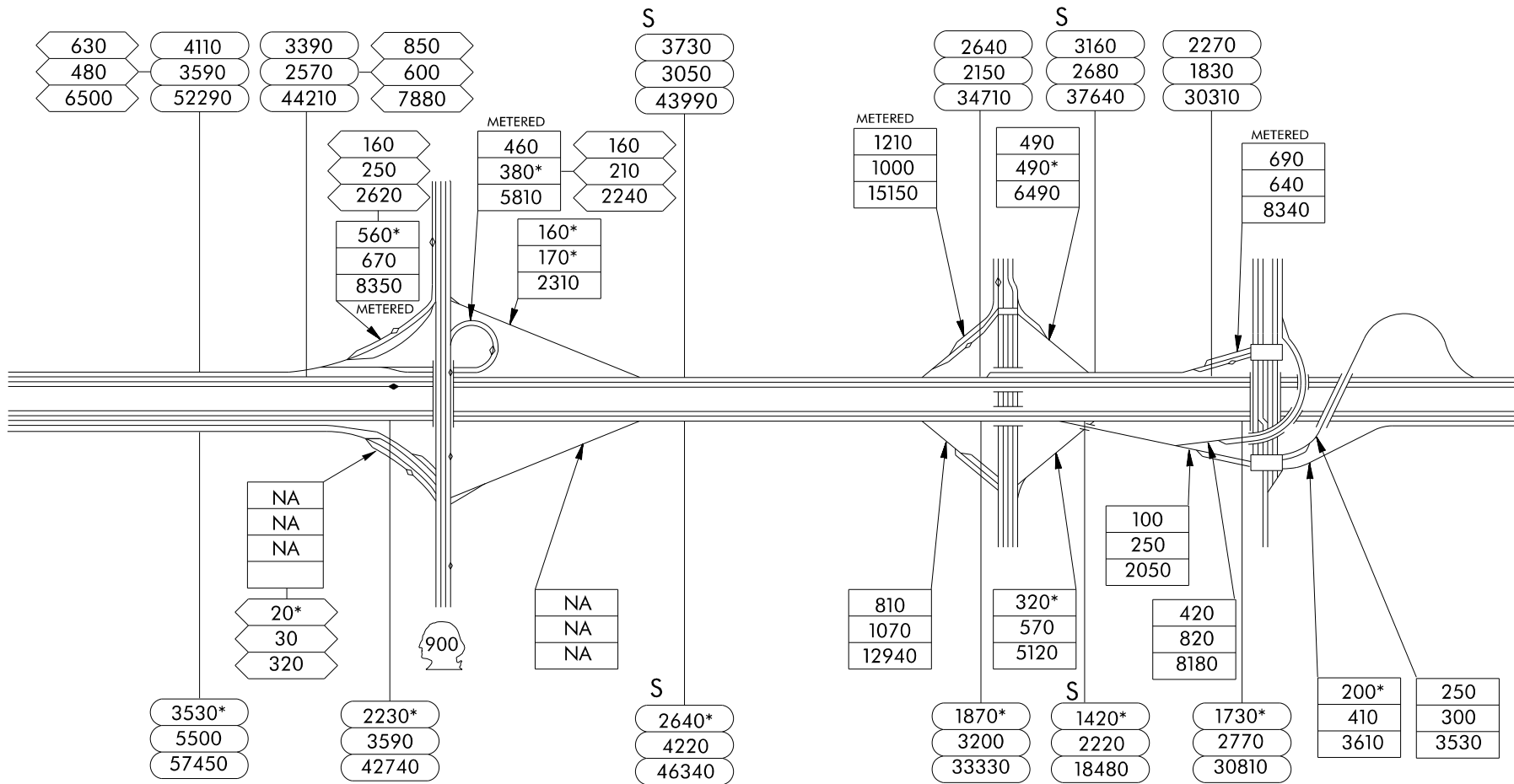



246TH AVE SE

256TH AVE SE

EXIT 20  
HIGH POINT WAY  
270TH AVE SE

S  
2650  
1870  
27650

S  
2590  
2140  
29780

S  
1940\*  
3200  
31840

S  
1960\*  
3230  
32350

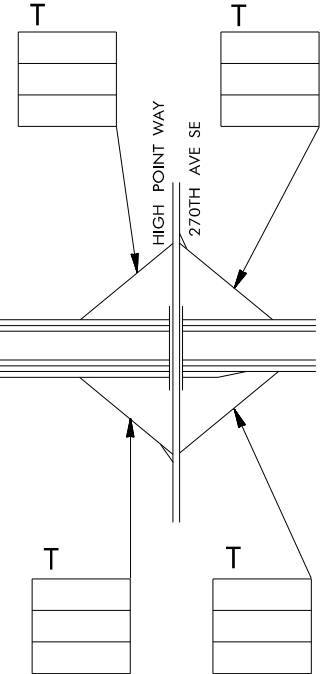

EXIT 22  
PRESTON-  
FALL CITY RD

EXIT 25  
SR 18

EXIT 27  
SE NORTH BEND WAY

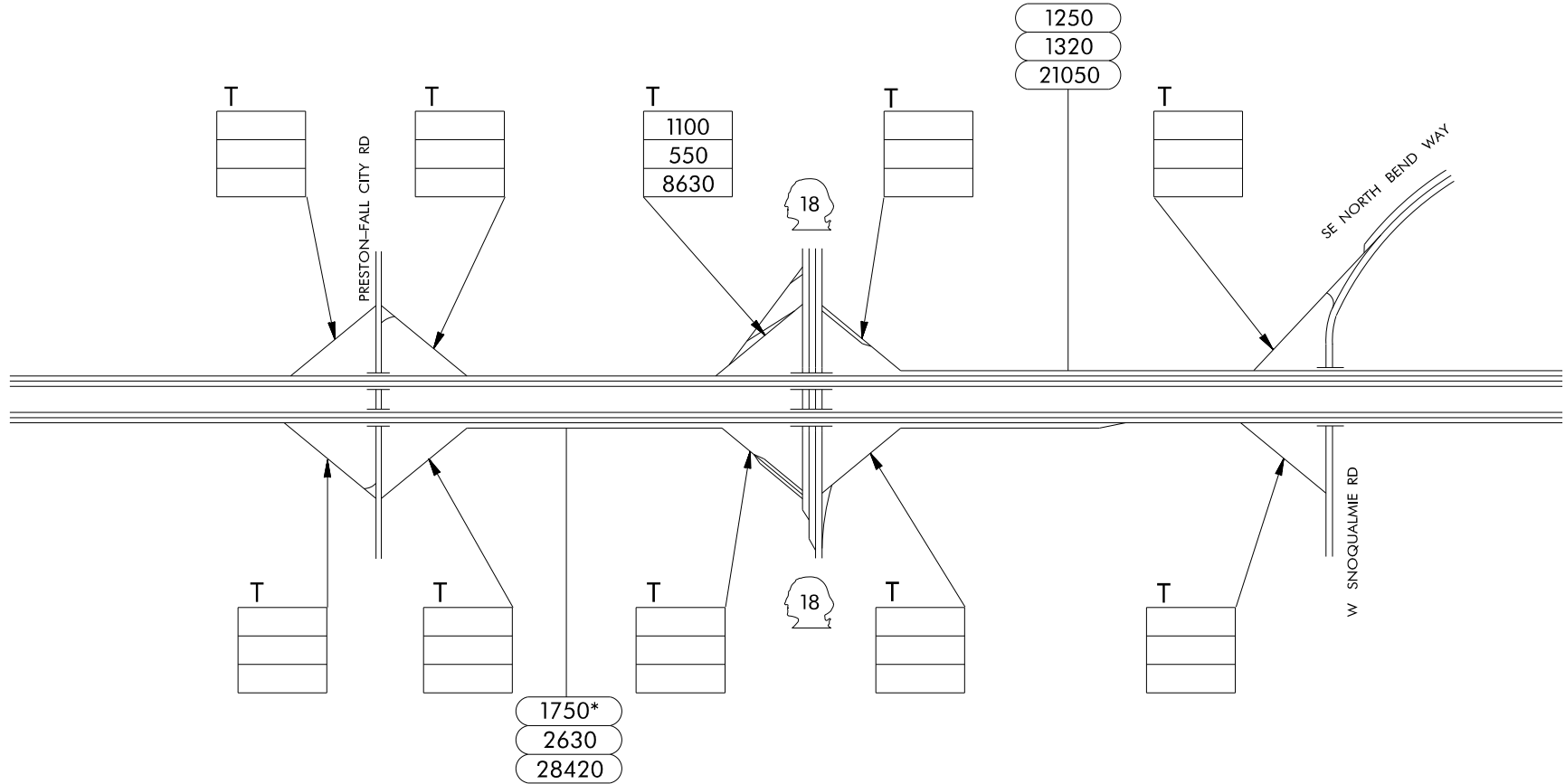

EXIT 31  
SR 202

EXIT 32  
436TH AVE SE

EXIT 34  
EDGEWICK ROAD

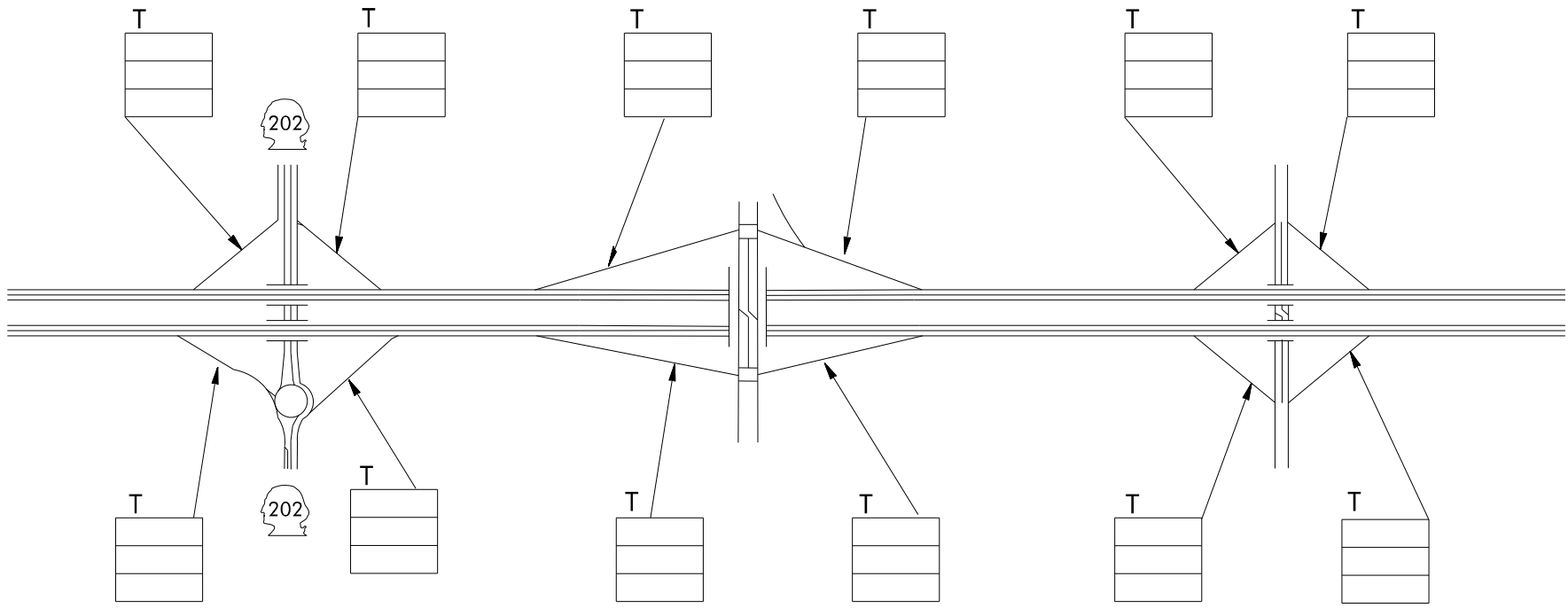



EXIT 1

I-5  
(TUKWILA)

ANDOVER PARK W

INTERURBAN AVE S

SR 181  
WEST VALLEY HWY

LONGACRES DR SW

2730	430	4490
3020*	310	4450*
49000	3970	81190

4130	590
3970*	580
71350	7490

4530	670
4340*	660
73070	8750

530*	30
760	60
9410	660



1780*	340*
1320*	380
24490	4790

990
970
15890

430
180
2910

METERED

300*
420
5190

520*
550
7790

SOUTHCENTER BLVD

518

1310*
1640
24820



1560	1600*
1670*	1250
29890	22250

420*
680*
7840

360*
690
8100

4400	460*
4670*	960
79010	10320

960
830*
12510

METERED

320*
520
5870



3670*	510*
4110	1190
70740	12610

S

3970*	500*
4710	1110
76090	12030



Washington State  
Department of Transportation



1  
OF  
16

POWELL AVE SW

EXIT 2  
SR 167  
RAINIER AVE S / VALLEY FWY

TALBOT RD  
SR 515

S 9TH ST



560	2620
590*	2290*
9200	42520

650	4640
640	4400*
9060	76580

540	4320
610	3850*
8620	66340

3700	860	4680	850
3510*	1320	4420*	1370
54900	16920	71090	17490

230	660
180	670*
2120	10650

1250
1240*
181810



1730*
1370*
25370

150
140*
2140

350*
800
9660

610
880
11260

1470*
1620
28170

210*
400
3680



730*
400
7590

1230*
1240*
15380

230*
420
3970

METERED
560*
550*
8310

330
130
1800

740
660
10140

700
630
9820

3180*	1190*	3510*	1250
4260	1270	4750	1230
58840	18520	66750	18520

480*	3870*
1000	4740
11440	75500

500*	1870*
930	2610
11170	37250

610	2090*
910	3040
12140	42000



Washington State  
Department of Transportation



2  
OF  
16

EXIT 4

SR 169  
MAPLE VALLEY RD

EXIT 4

SR 900  
SUNSET BLVD

EXIT 5

SR 900  
NE PARK DR



NE 24TH ST

S

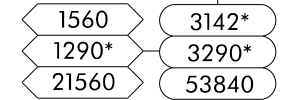
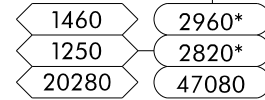
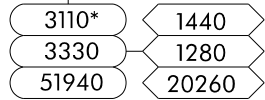
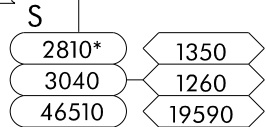
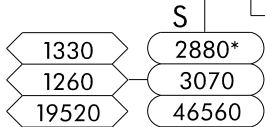
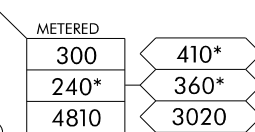
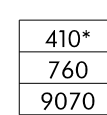
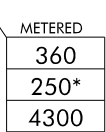
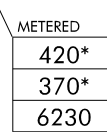
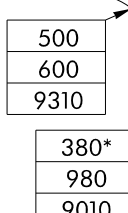
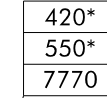
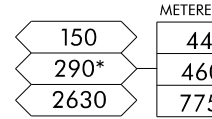
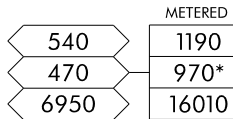
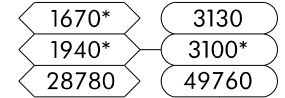
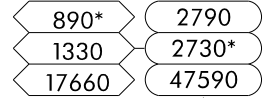
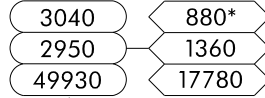
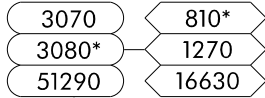

EXIT 6

NE 30TH ST

EXIT 7

NE 37TH ST  
KENNYDALE HILL

NE 44TH ST

SE 72ND ST

SE 64TH ST

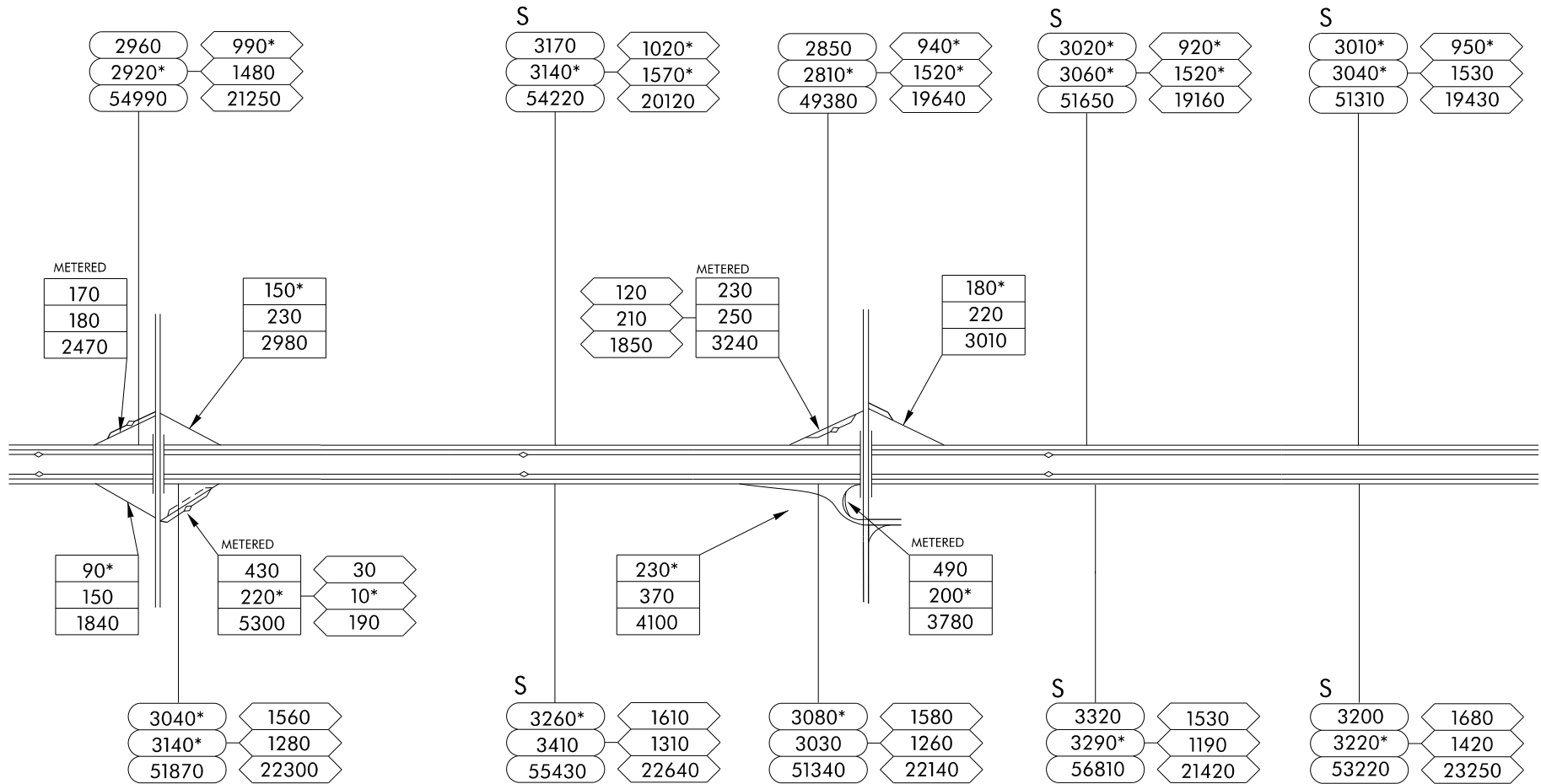

Washington State  
Department of Transportation



4  
OF  
16





EXIT 9

EXIT 10

SE 59TH ST

SE 52ND ST  
112TH AVE SE

SE 47TH ST

COAL CREEK PKWY

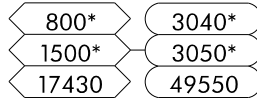
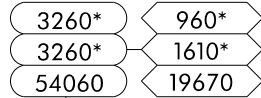
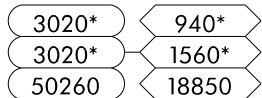
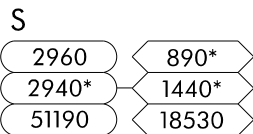

METERED

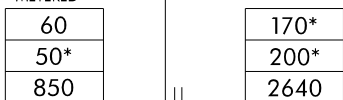

METERED

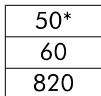
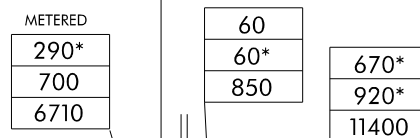

METERED

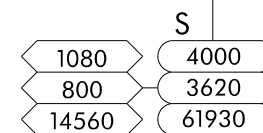
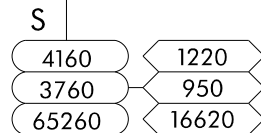
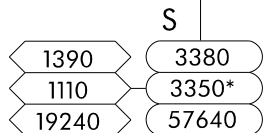
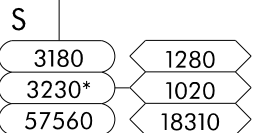
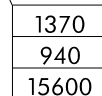
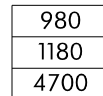
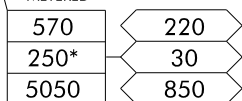

Washington State  
Department of Transportation



5  
OF  
16



SE 39TH ST

EXIT 11

I-90

SE 24TH ST

SE 17TH ST

S

2440*	570*
2490*	1230*
36650	13260

2460*	550*
2550*	1210*
36890	12860

S

4870*	210	550*	5000*	130	490*
5080*	560	1170*	5330*	660*	1110*
76750	4410	12310	79070	4110	11150

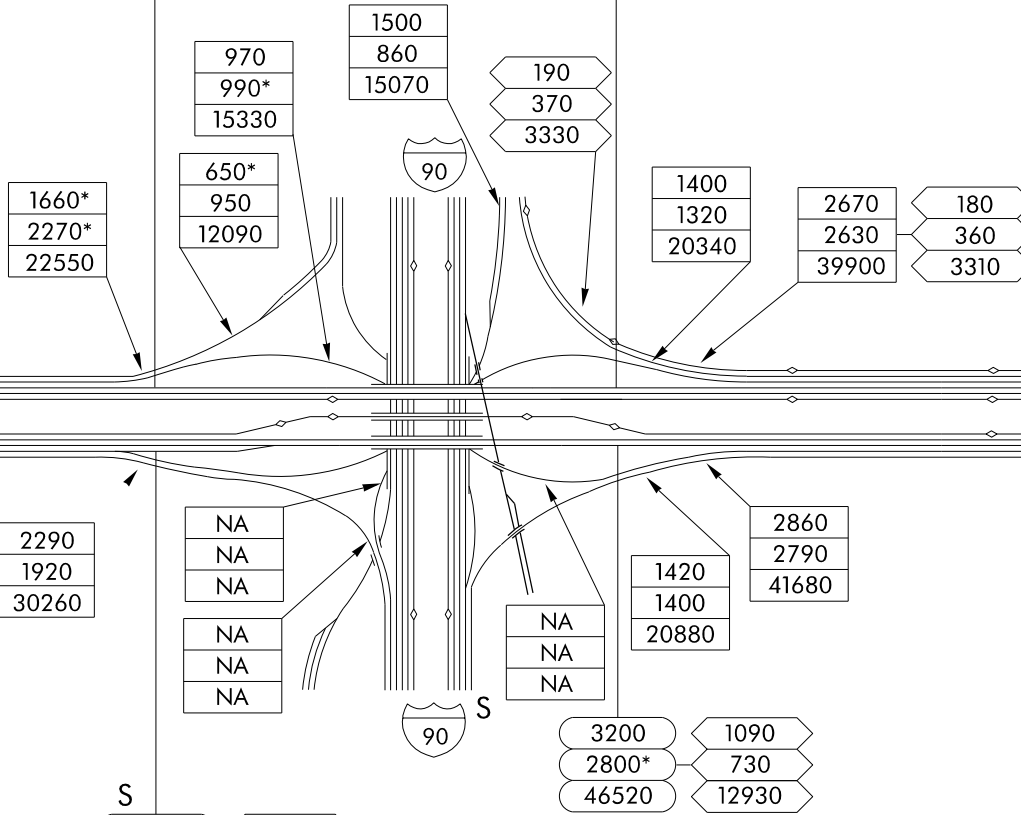

2290
1920
30260

NA
NA
NA

NA
NA
NA

S

3180	1080
2780*	720
48030	13300

S

5960	1140
5260*	810
87790	13410

S

6010	1160
5580*	790
89050	12150

EXIT 12  
SE 8TH ST

MAIN ST

S  
4650 530  
5040\* 1030\*  
75920 10750

METERED  
260\* 30\*  
360 210  
4270 1170

660  
660  
7650

220  
190  
2950

650  
400\*  
5820

116th Ave SE

METERED  
NA 180  
NA 140  
NA 1710

S  
5140 930  
5020\* 750  
80760 10310

S  
4430 690  
4390\* 690  
69600 8700



Washington State  
Department of Transportation



7  
OF  
16

EXIT 13A  
NE 4TH ST

HOV ONLY EXIT  
NE 6TH ST

EXIT 13B  
NE 8TH ST

NE 10TH ST

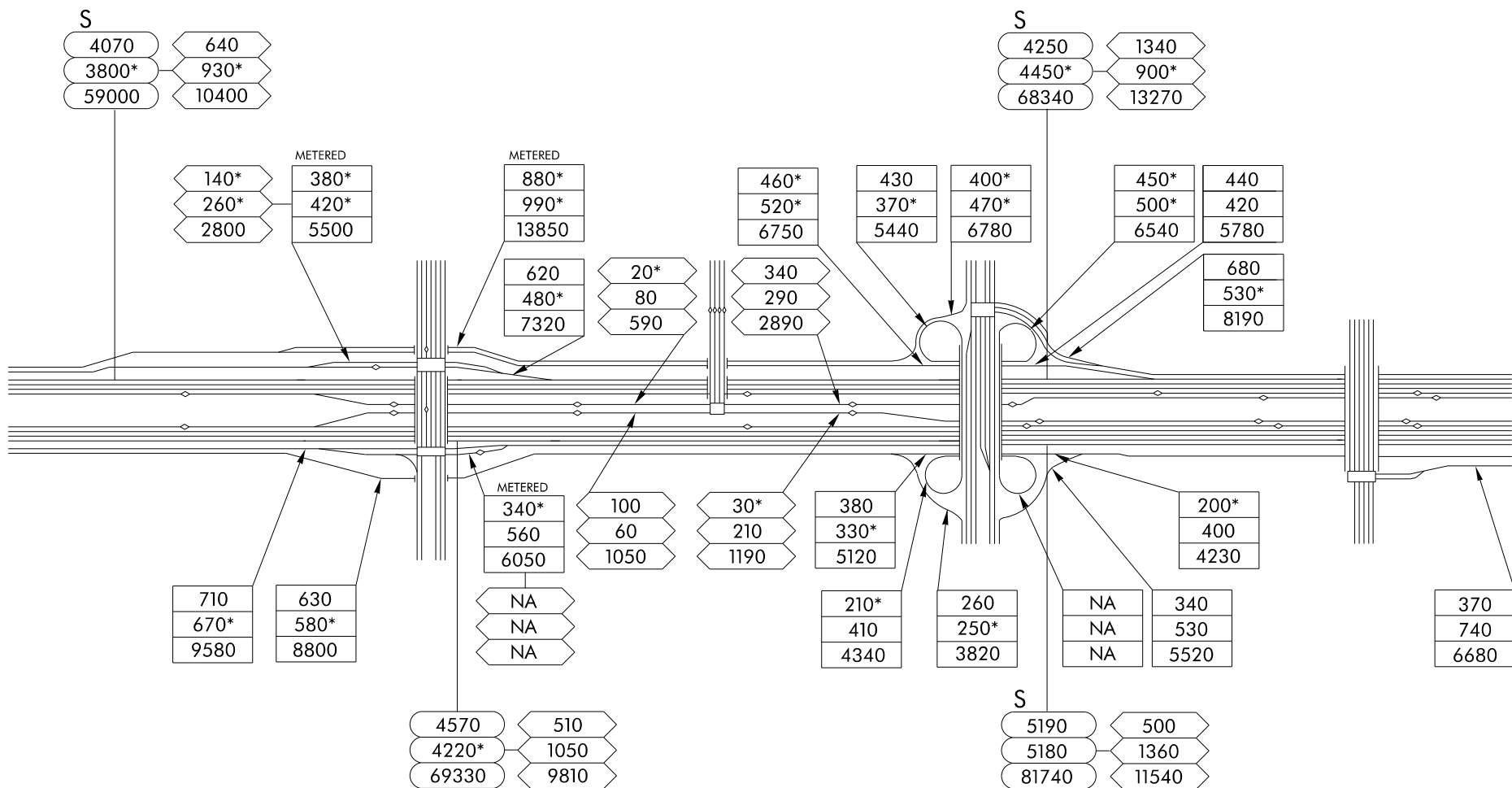



EXIT 14

NE 14TH ST

SR 520  
(NORTHUP)

NE 28TH ST

NE 37TH ST

NE 46TH ST

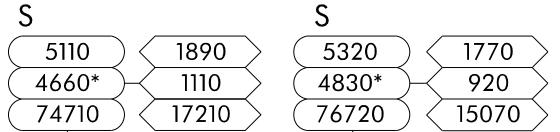
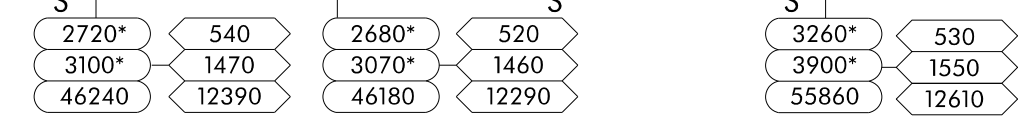
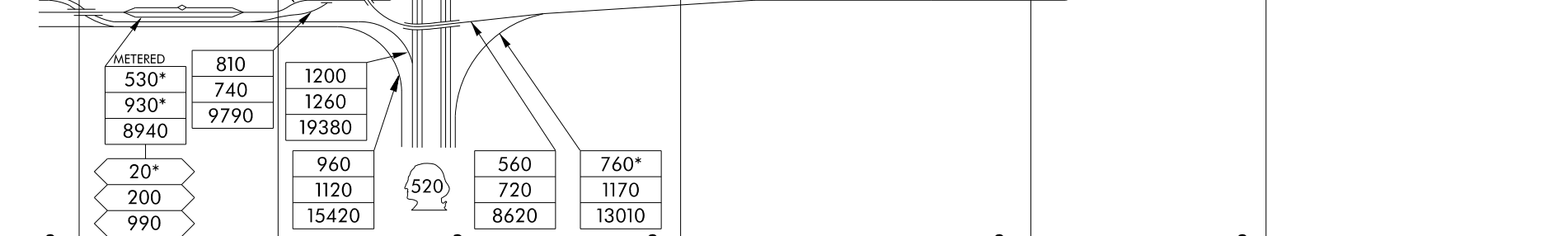
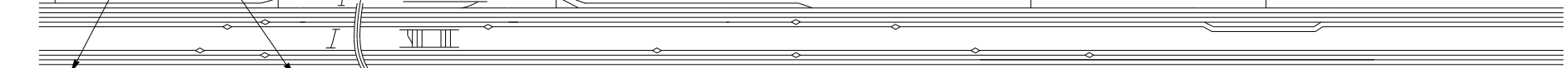
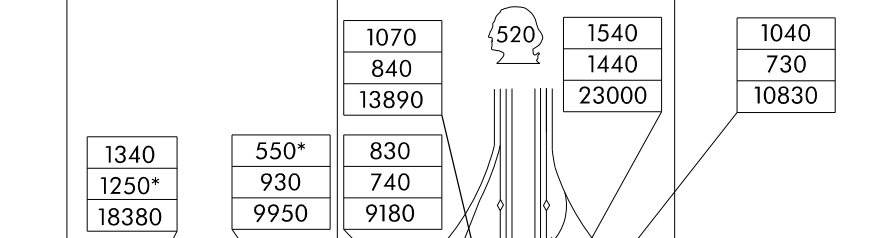
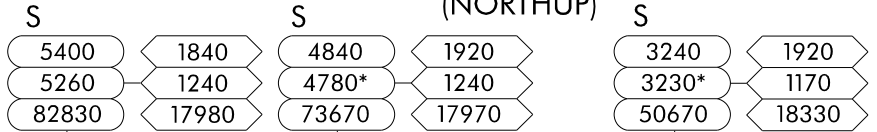

S  
5400  
5260  
82830

1840  
1240  
17980

S  
4840  
4780\*  
73670

1920  
1240  
17970

S  
3240  
3230\*  
50670

1920  
1170  
18330

S  
5110  
4660\*  
74710

1890  
1110  
17210

S  
5320  
4830\*  
76720

1770  
920  
15070

1340  
1250\*  
18380

550\*  
930  
9950

1070  
840  
13890

830  
740  
9180



1540  
1440  
23000

1040  
730  
10830

METERED  
530\*  
930\*  
8940

810  
740  
9790

1200  
1260  
19380

960  
1120  
15420



560  
720  
8620

760\*  
1170  
13010

S  
2720\*  
3100\*  
46240

540  
1470  
12390

S  
2680\*  
3070\*  
46180

520  
1460  
12290

S  
3260\*  
3900\*  
55860

530  
1550  
12610

S  
4390\*  
5190\*  
75680

590\*  
2260  
18030

S  
4600\*  
5240\*  
75290

650\*  
2580  
18950



Washington State  
Department of Transportation



9  
OF  
16

NE 57TH ST

EXIT 17  
NE 70TH PL

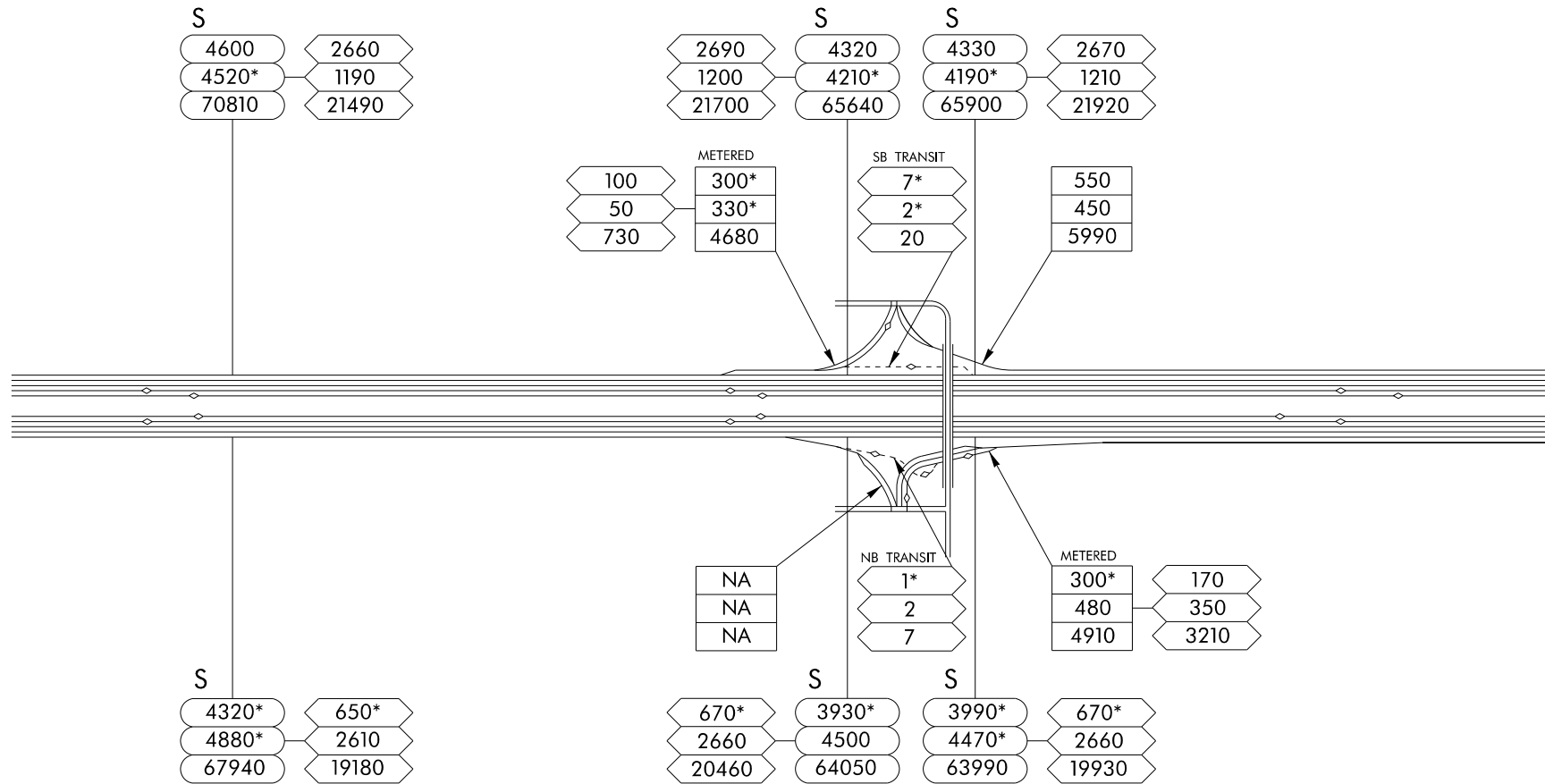



EXIT 18  
NE 85TH ST

NE 97TH ST

NE 106TH ST

S

4190	2630
3800*	1190
61120	21570

50
20
340

540
510
8280

350*
410
5410

METERED

370*
400*
5280

390
430
5540

METERED

360*
380*
5020

550
510
8310

S

4190	2650
3780*	1200
60910	21720

S

5380	2860
5000*	1270
77580	22430

S

4350	2750
3950*	1160
70880	24090

410
380
5420

METERED

350*
430*
5500

270*
270*
3990

METERED

390*
430*
6220

380*
470
5980

410
360*
5270

S

3650*	670*
4290*	2710
60790	20450

40*
200
1460

S

3650*	660*
4250*	2700
63340	21160

4740*	720*
5500*	3040
76220	21930

720*	3040
21930	

S

4420*	680*
5090*	2680
74230	21020



Washington State  
Department of Transportation



11  
OF  
16

EXIT 20A  
NE 116TH ST

EXIT 20\20B  
NE 124TH ST  
TOTEM LAKE BLVD

NE 128TH ST

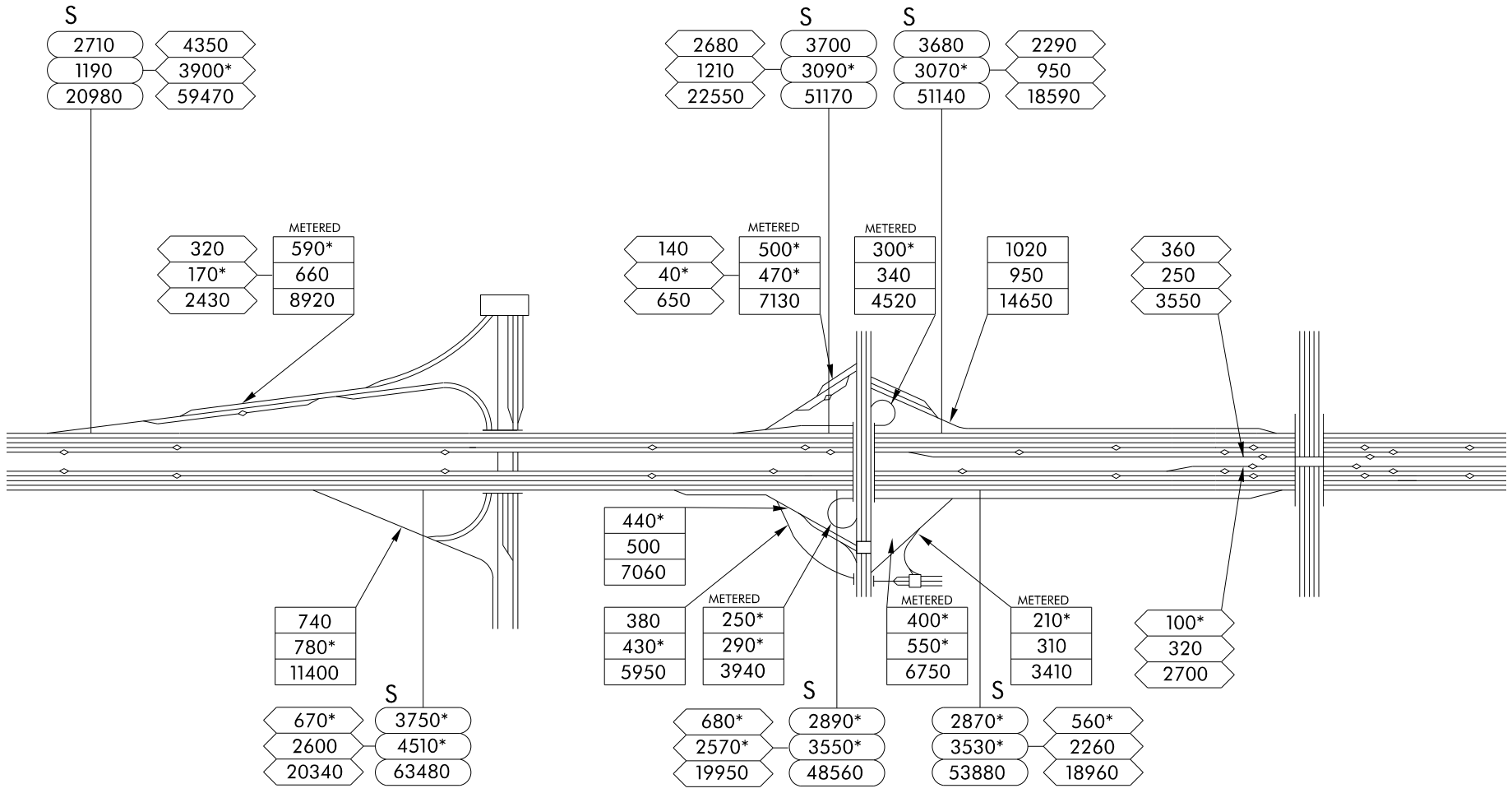



NE 132ND ST NE 140TH ST NE 144TH ST

EXIT 22  
NE 160TH ST  
JUANITA-WOODINVILLE WY NE

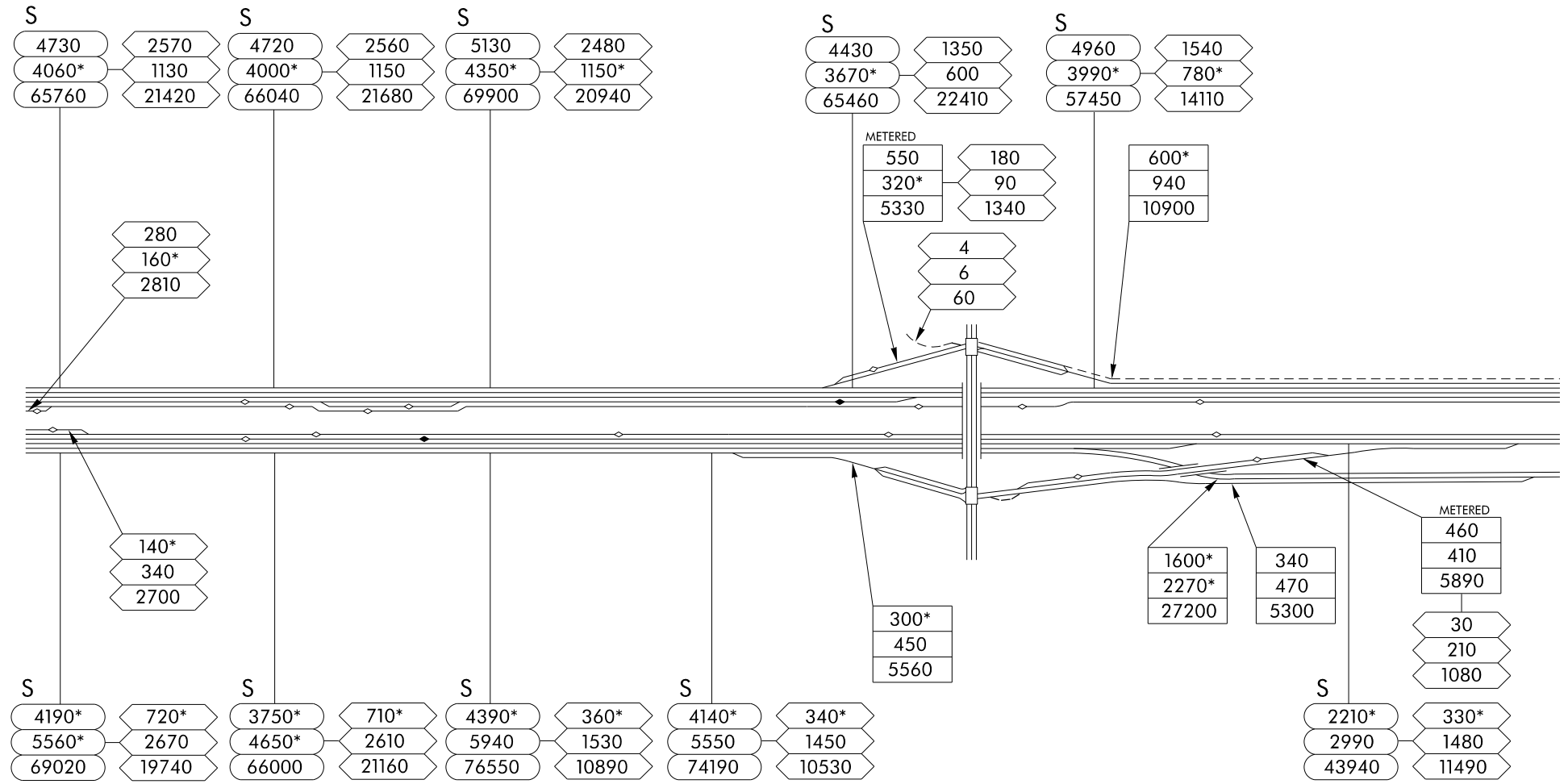

EXIT 23  
SR 522  
(WOODINVILLE)

EXIT 24  
NE 195TH ST  
BEARDSLEE BLVD

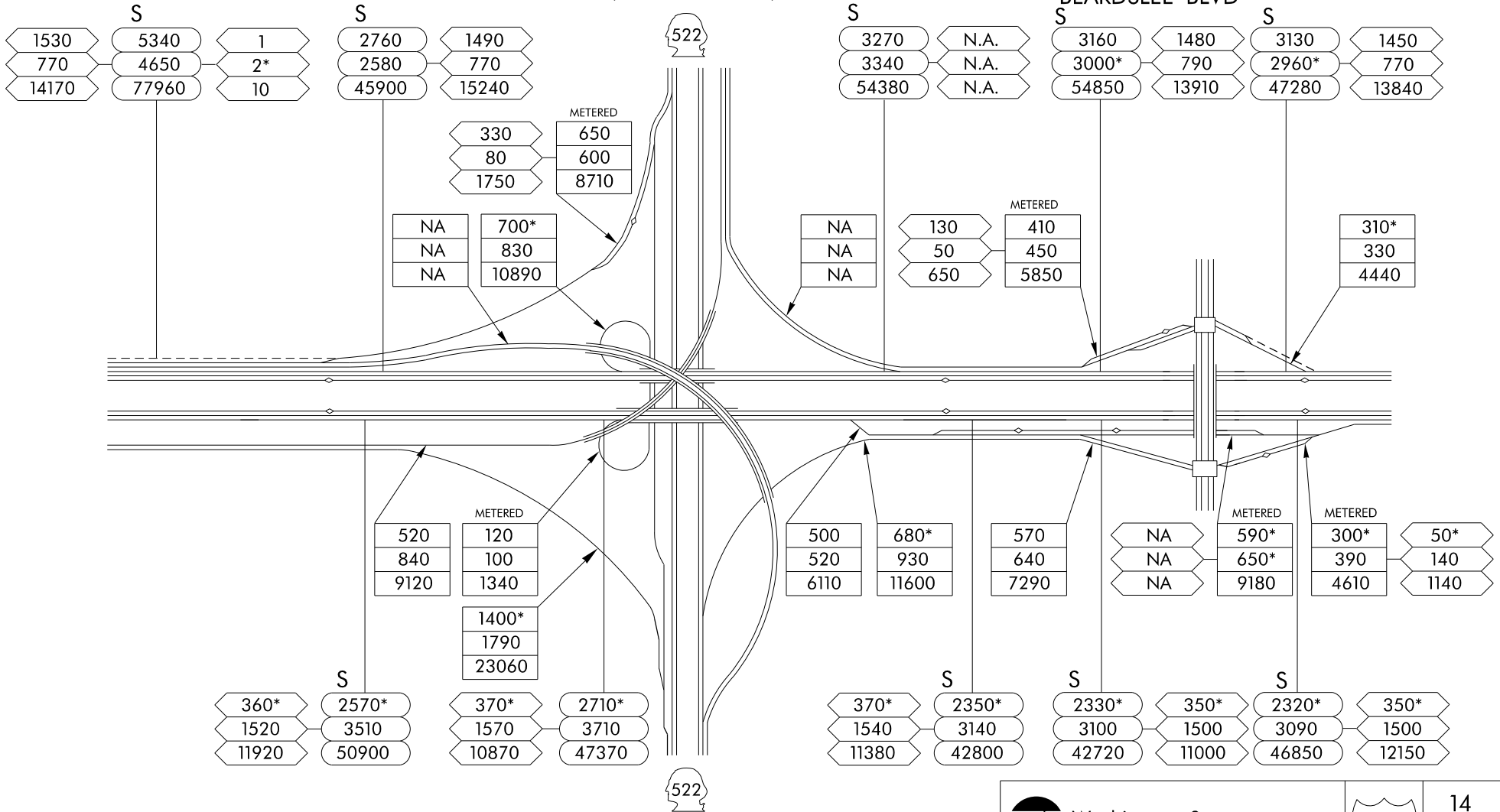

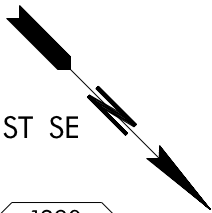

EXIT 26

SR 527

242ND ST SE

236TH ST SE

230TH ST SE

BOTHELL - EVERETT HWY

216TH ST SE

S

3610	1690
3450*	960*
52540	16100

S

3400	1440
3230*	780*
54370	14440

S

3500*	1440
34120*	780*
53010	13480

S

2510	1260
2300*	670*
40330	12460

S

2540	1250
2330*	650*
37260	11210

S

3110	1290
3220	650*
46490	10450

METERED

570*	10
540	4
7650	70

METERED

470*
430
6870
210
240
3690
310
250*
4020

METERED

NA
NA
NA

350
350
5510

140*
180
2390

METERED

250*	20*
380	80
4580	510

S

3780*	360*
5230	1540
63790	10530

S

3260*	330*
4460	1340
59030	10180

S

3250*	330*
4420	1340
53010	9130

S

2260*	330*
2900	1320
40110	10100

S

2270*	340*
2900	1330
38220	9860

S

2940*	330*
3230*	1310
48090	10150



Washington State Department of Transportation



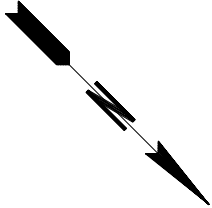

208TH ST SE

200TH ST SE

DAMSON RD

FILBERT RD  
SR 524

I-5  
(Lynnwood)

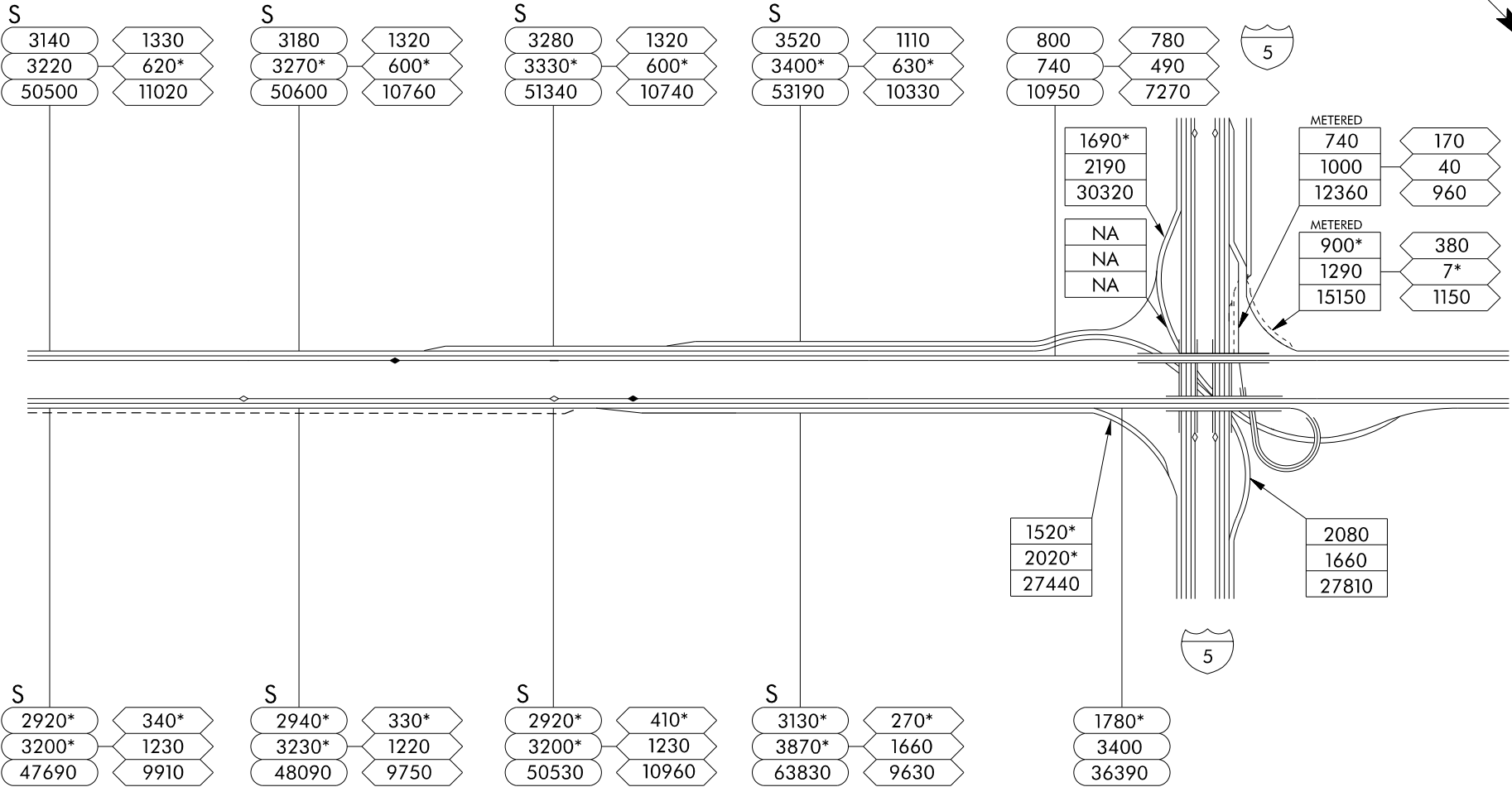

Washington State  
Department of Transportation



16  
OF  
16



I-5

WEYERHAEUSER WAY S  
32ND AVE S

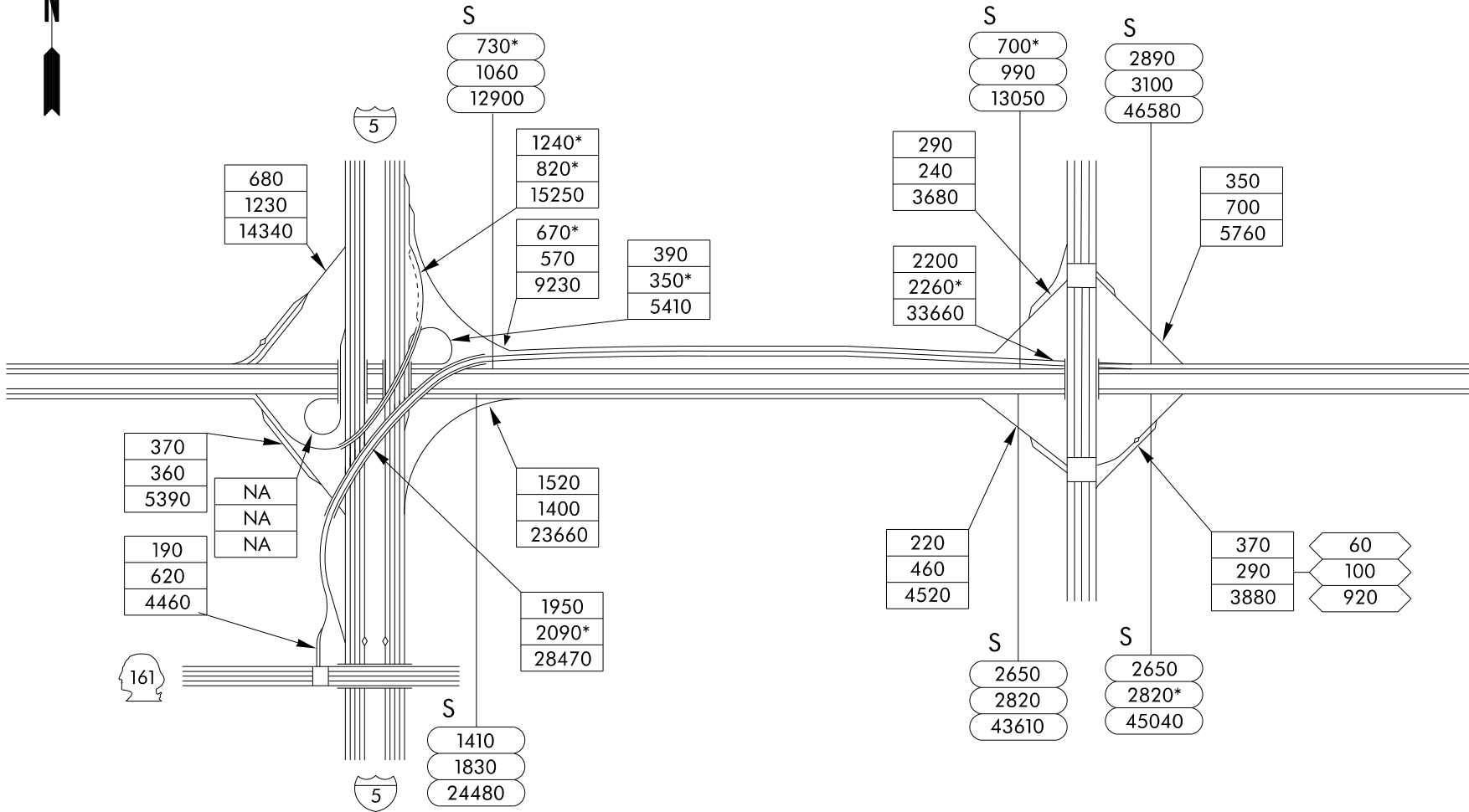

Washington State  
Department of Transportation



18

1  
OF  
7



WEST VALLEY SR 167  
HWY

S

3260
3760
52580

S

3200
3710
52810

S

2300
2520
35300

NA	230	950
NA	290	1240
NA	3430	17160

230	950
290	1240
3430	17160

570	810*	NA
580*	510	NA
9250	9900	NA

810*	NA
510	NA
9900	NA

470*
560*
7830

810
740
12800

300
310
4620

360*
420
6410

1150*
1280
18940

650
620
9200

S

3230
3260
49900

S

3060
3010
48710

S

2760
2740
42950



Washington State  
Department of Transportation



2  
OF  
7



"C" ST

"A" ST

AUBURN WY  
SR 164

"V" ST

S  
2560  
2640  
40150

300  
330  
4130

940  
730  
12190

NA  
NA  
NA

S  
1700  
1920  
26480



860  
800  
14240

300  
550  
5830

S  
2010  
2530  
29250

130\*  
280  
2740

560  
530  
8360

NA  
NA  
NA

470  
400  
5690

S  
2500  
2860  
41740



S  
NA  
NA  
NA

S  
2080  
2270  
27920



Washington State  
Department of Transportation



3  
OF  
7

AUBURN-  
BLACK DIAMOND RD

SE 304TH ST

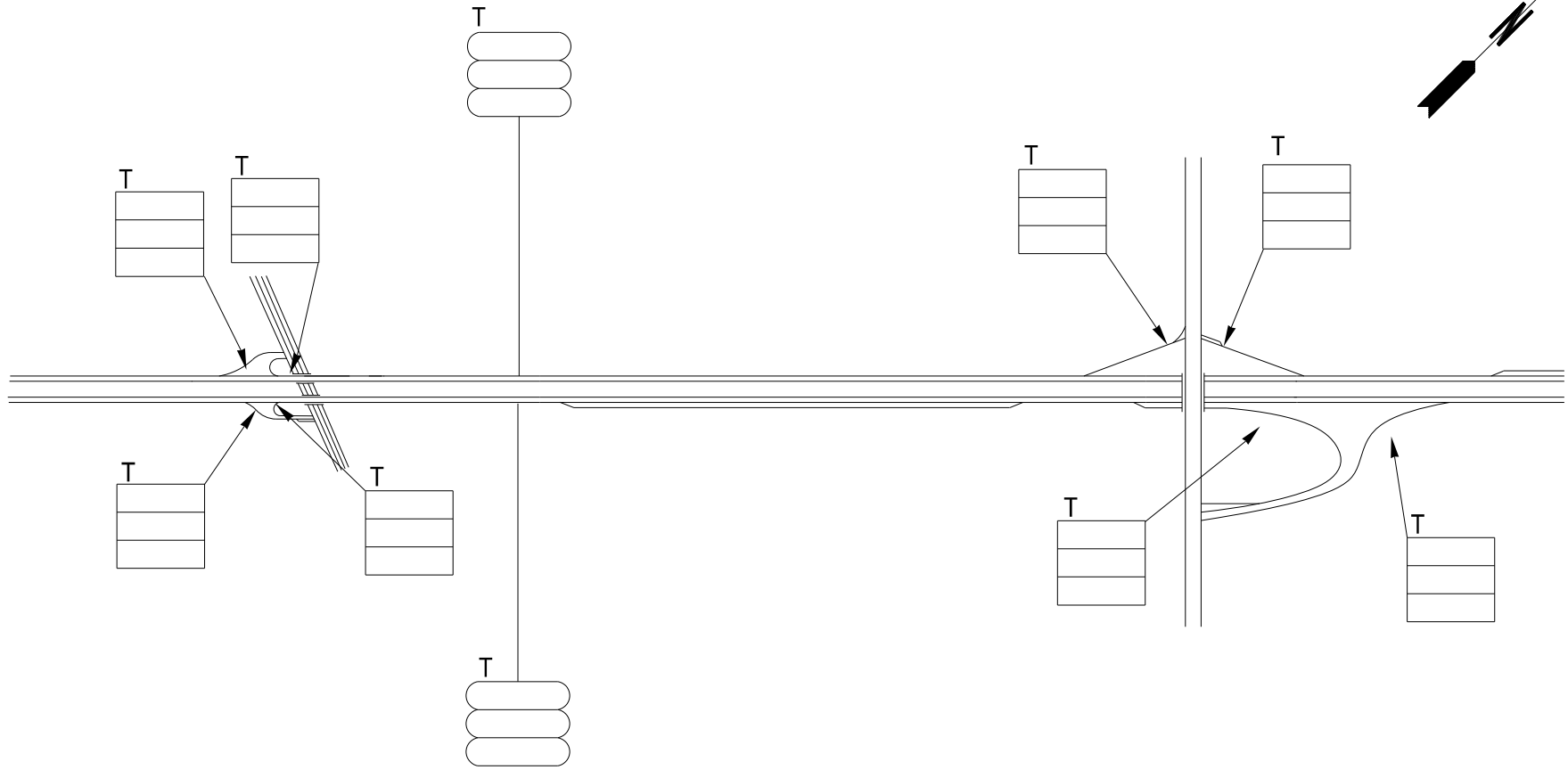

Washington State  
Department of Transportation



18

4  
OF  
7



SE 272ND ST  
SR 516

180 AVE SE

SE 256TH ST

SE 252ND ST

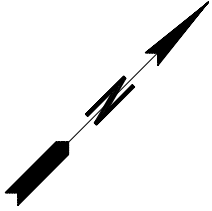

S  
940  
1740  
20040

S  
960\*  
1870  
19130

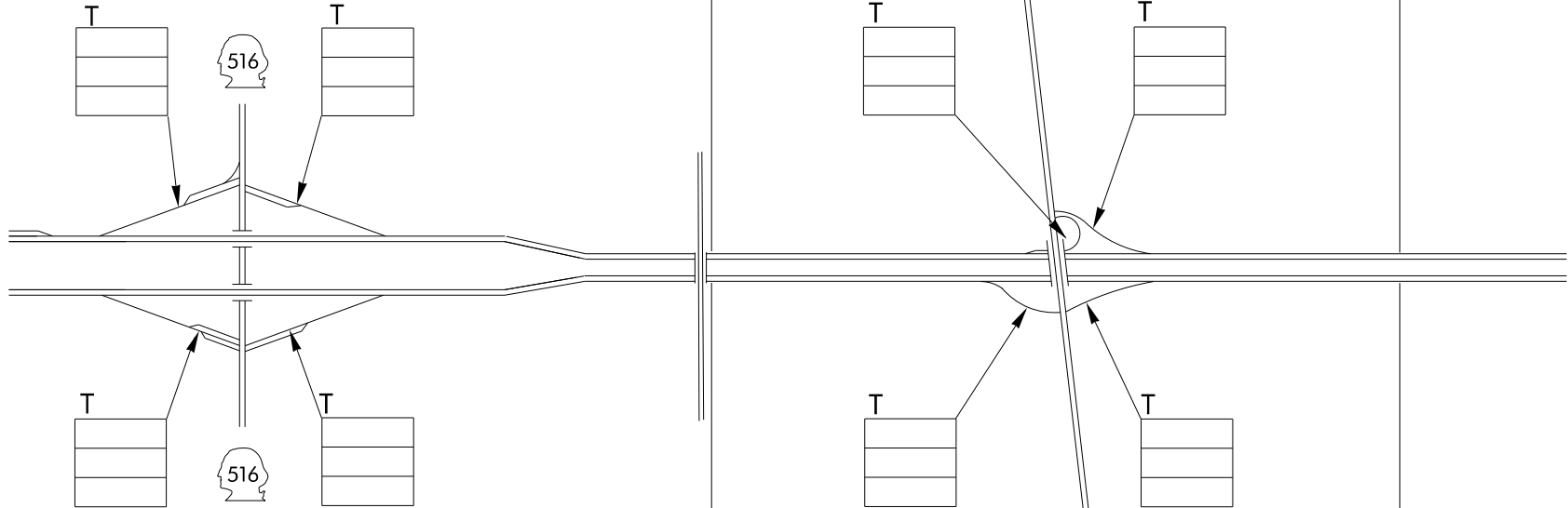

S  
1430  
1140  
19770

S  
1630  
1330  
21680



Washington State  
Department of Transportation



5  
OF  
7

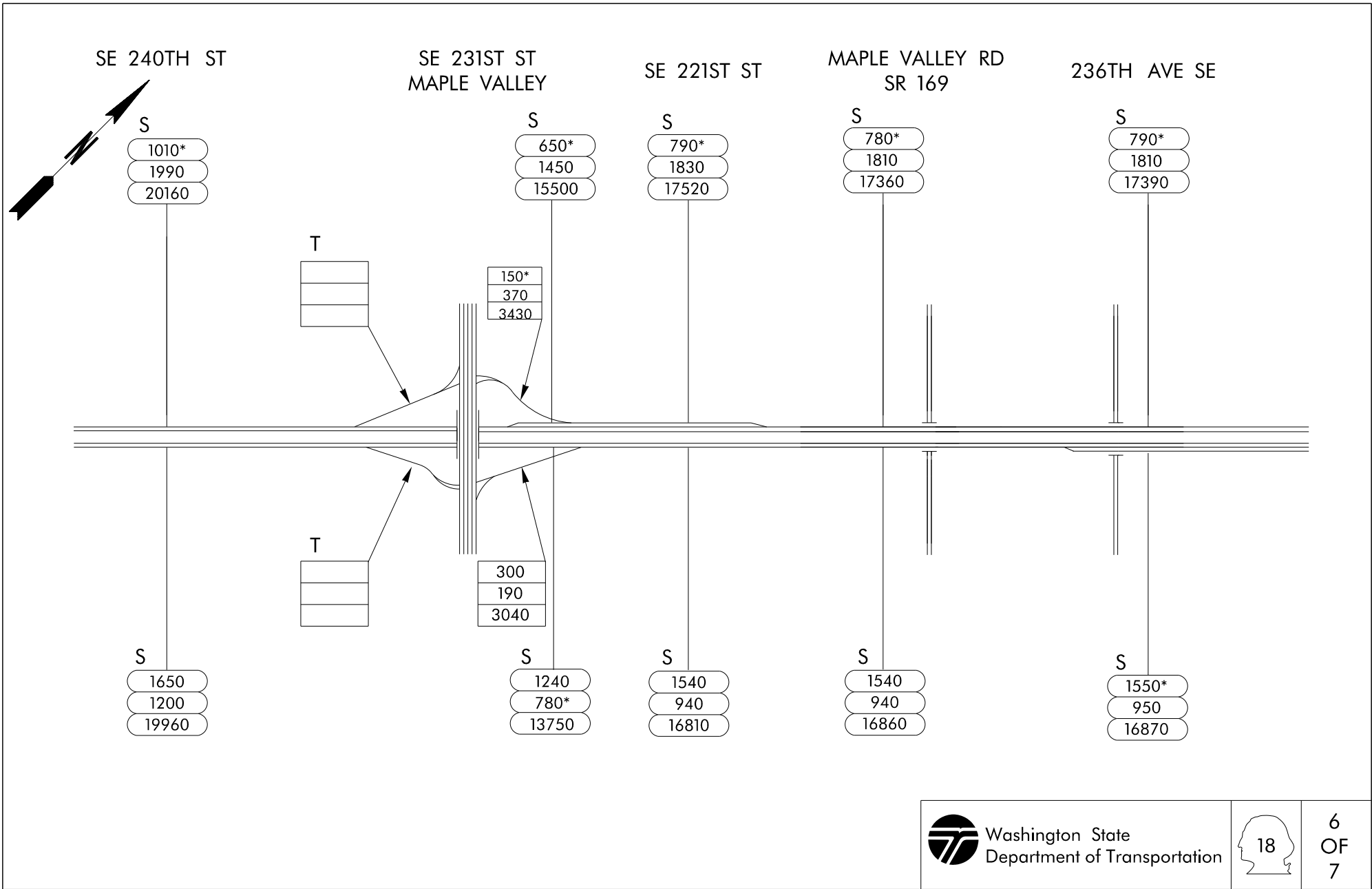

244TH AVE SE

SE 200TH ST

ISSAQUAH-HOBART RD

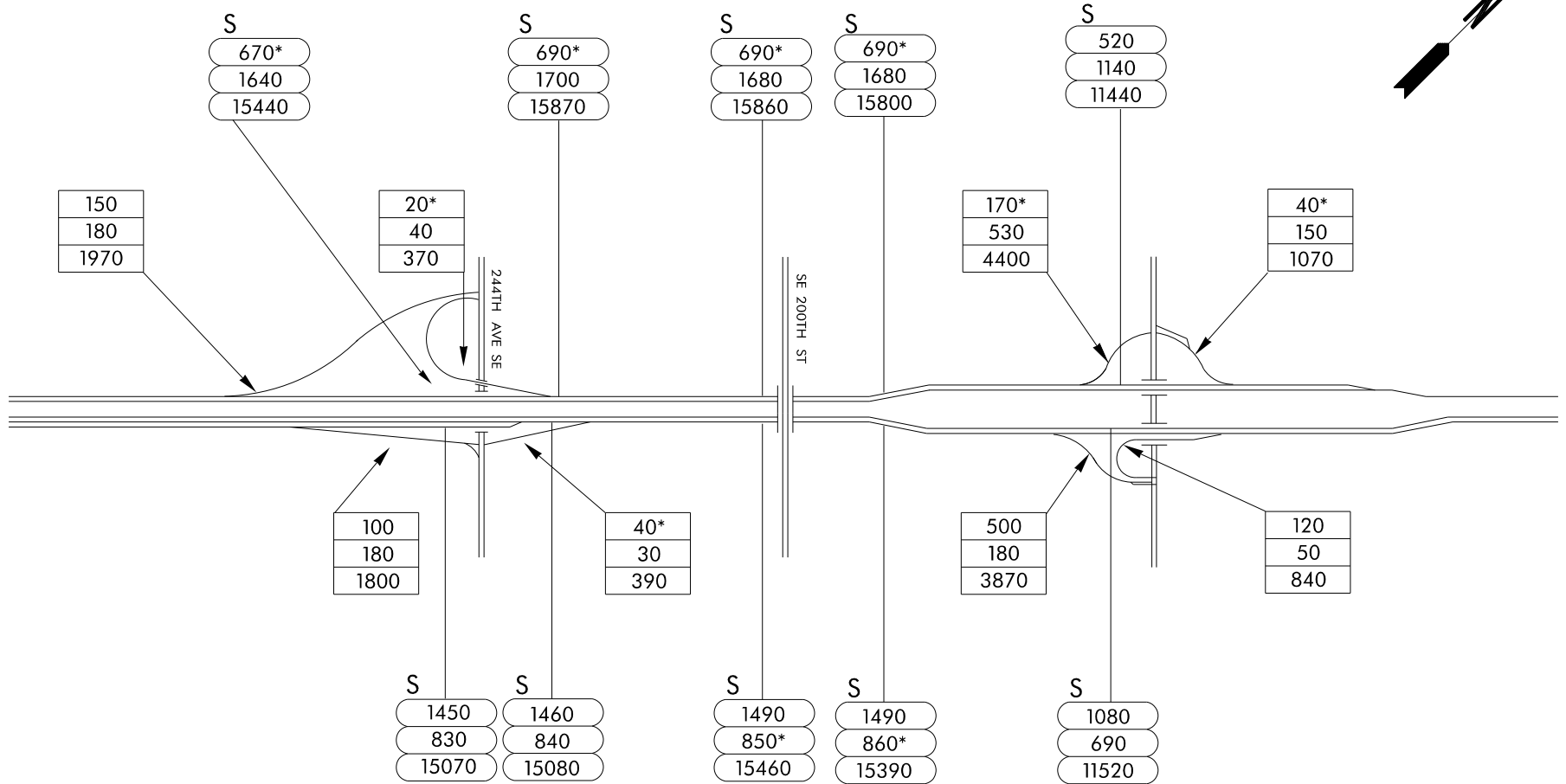
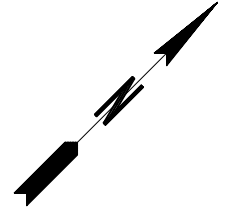

Washington State  
Department of Transportation



18

7  
OF  
7



SR 599  
TUKWILLA INTERNATIONAL BLVD

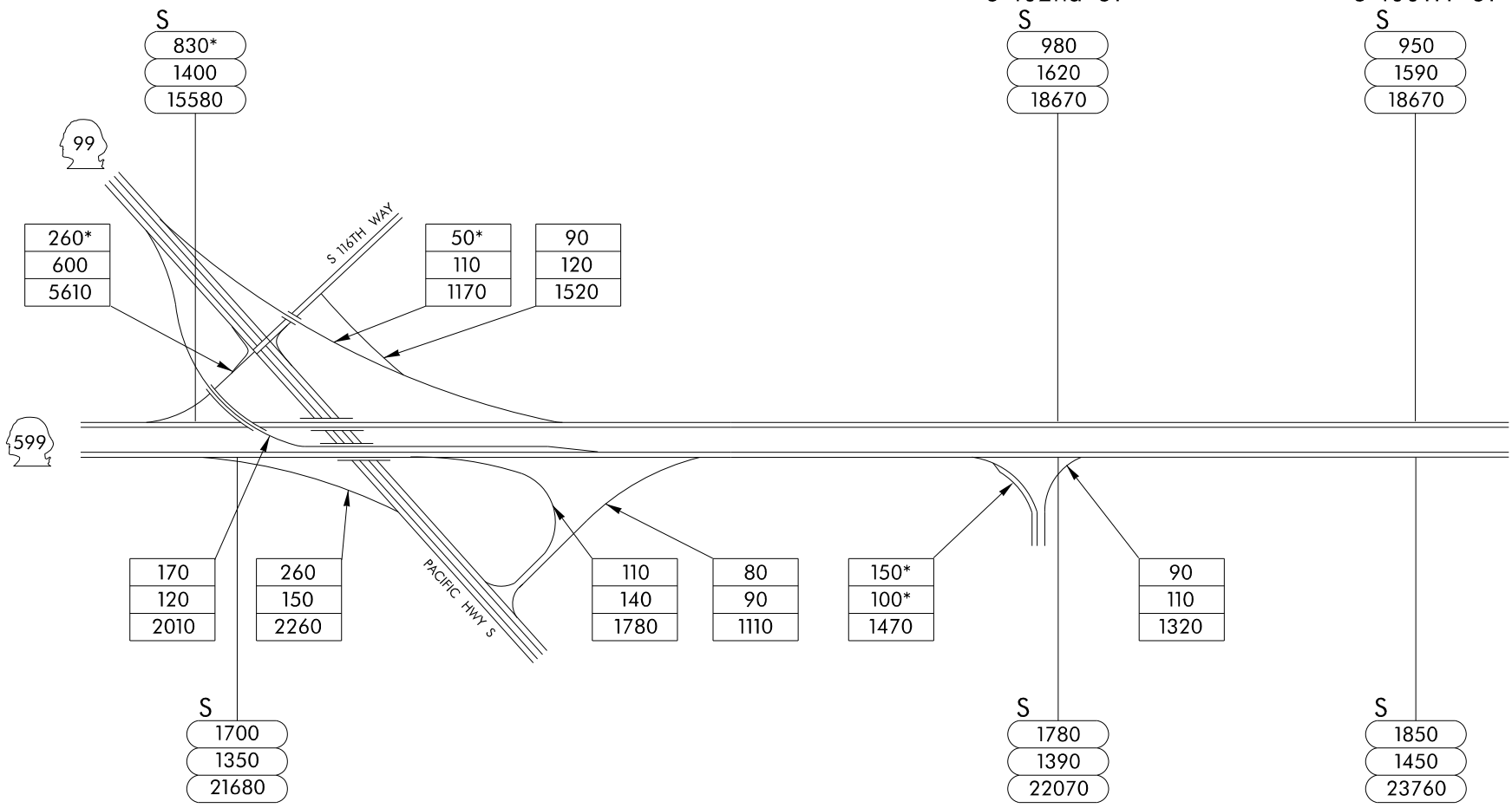



DES MOINES MEMORIAL DR  
14TH AVE S

S CLOVERDALE ST

S KENYON ST

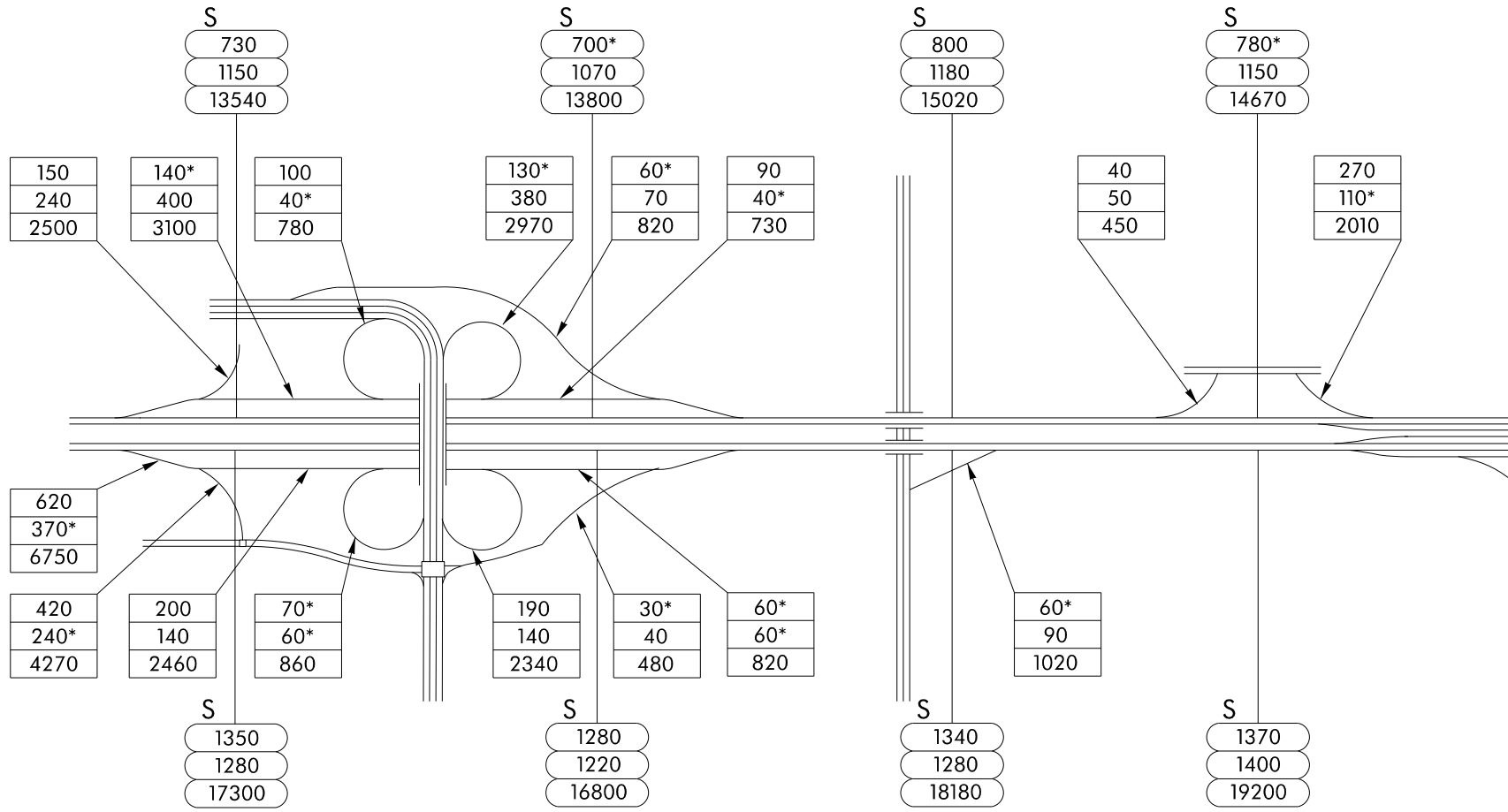

SR 509  
S HOLDEN ST



1ST AVE BRIDGE S

1190*	150*
2790	960
27430	5670

270
340
3940

920*
1360
16480



280*
390
5050



1530
1550
21780

2410	1080
1590	170
28520	5360



Washington State  
Department of Transportation



3  
OF  
5



S LANDER ST

ROYAL BROUGHAM

ER 2

ER 6

S  
1210  
2760  
26540

500  
1100  
11880

S  
710  
1670  
14660

S  
1320  
2390  
19640

S  
1310  
2380  
21770

SR 99 Tunnel

1140  
750  
12160

600  
630  
5770

S  
2740  
2000  
29590

S  
1760  
1310  
17090

S  
2190  
1860  
22110

S  
2180  
1860  
22070



Washington State  
Department of Transportation



4  
OF  
5



ER 10

- S
- 1310
- 2380
- 21700

ER 14

- S
- 1310
- 2380
- 21700

MERCER ST

- S
- 1190
- 2010
- 20420

COMSTOCK ST

- S
- 2140
- 2490
- 27500

SR 99 Tunnel

- 1120
- 980
- 12220

- 170
- 470
- 3930

- 660
- 390
- 5520

- 400\*
- 1040
- 8800

- S
- 1310
- 2380
- 22050

- S
- 2160
- 1840
- 19840

- S
- 1510
- 1450
- 18300

- S
- 1880
- 2770
- 27650



Washington State  
Department of Transportation



5  
OF  
5





Ellingson Rd

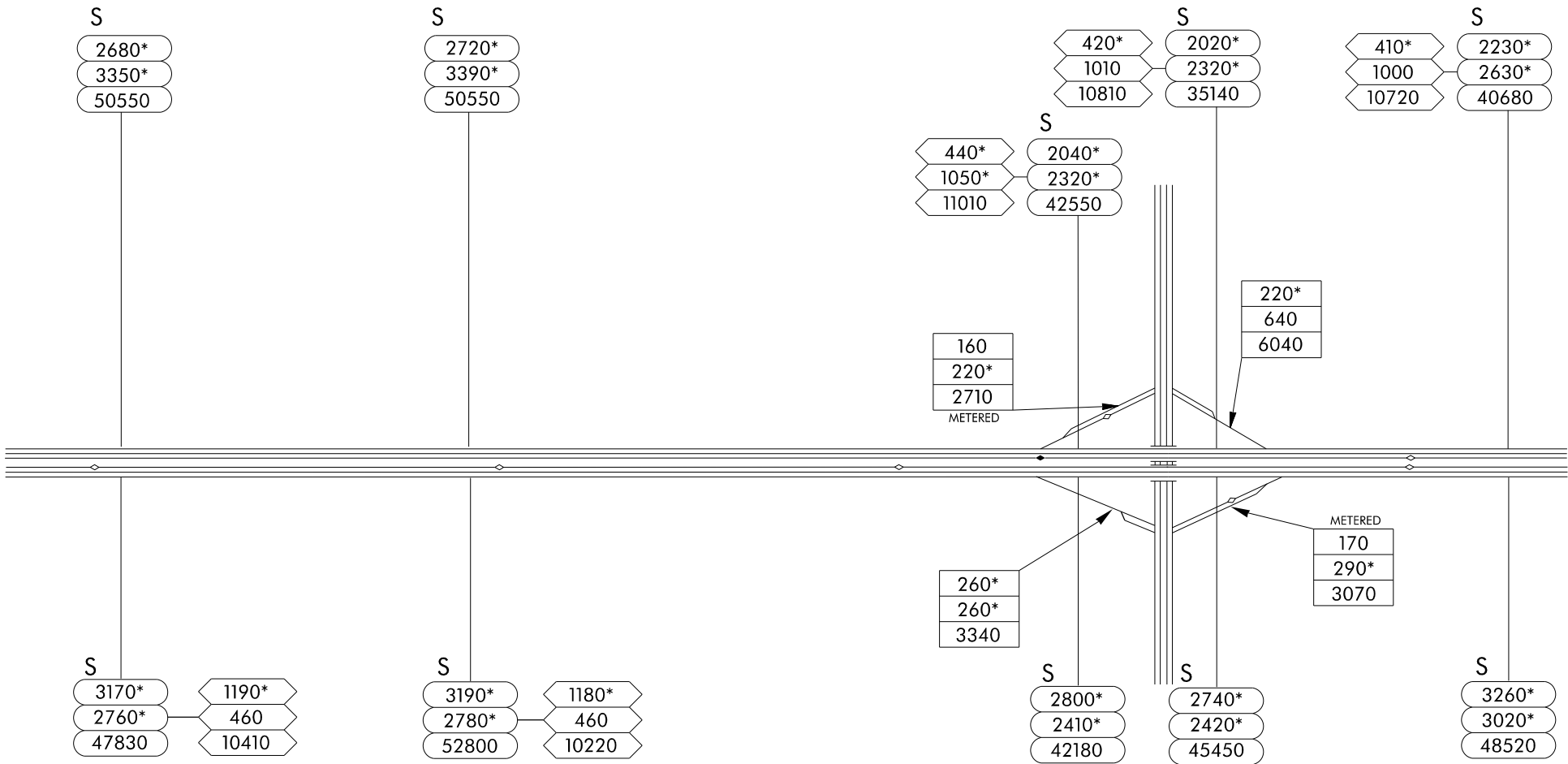

7TH Ave N

15TH ST SW

SR 18

S

S

15TH ST NW

S

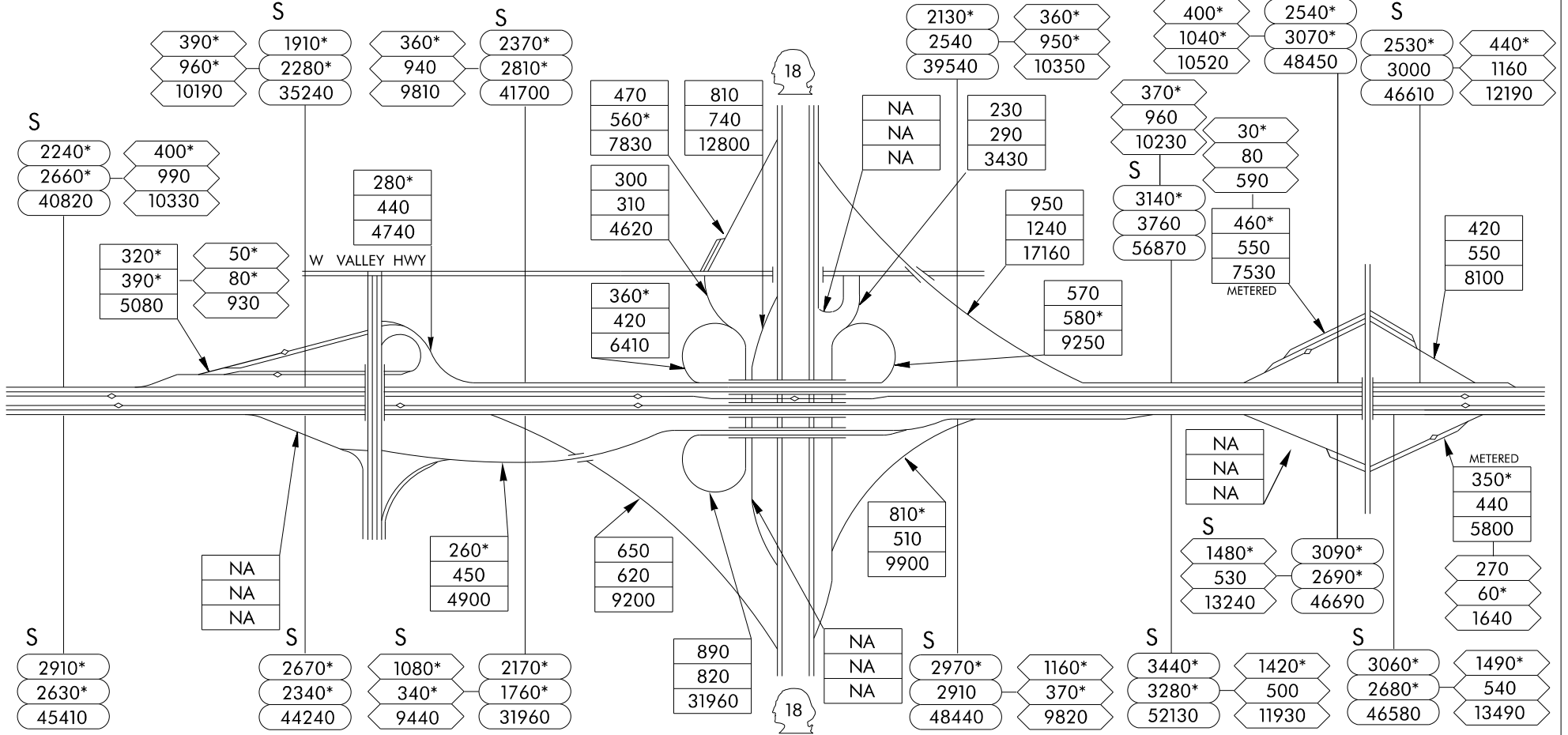



Emerald Downs

34TH ST NW

37TH ST NW

S 277TH ST

S 269TH ST

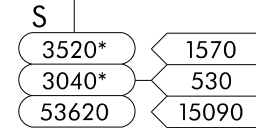
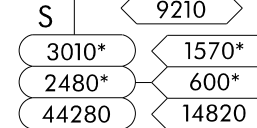
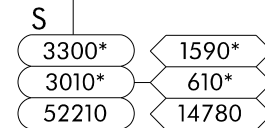
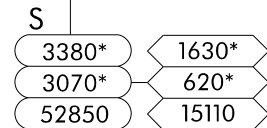
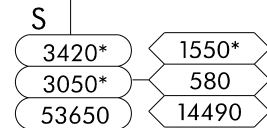
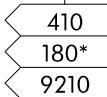
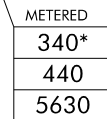
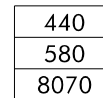
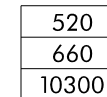
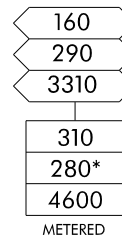
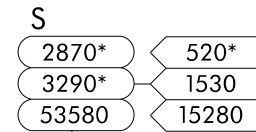
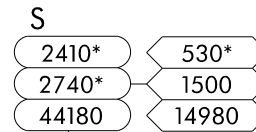
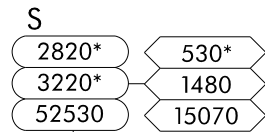
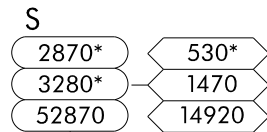
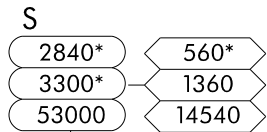

Washington State Department of Transportation



167

3 OF 6



GREEN RIVER

SR 516 WILLIS ST

JAMES ST

4TH AVE

84TH AVE S CENTRAL AVE

S

2870*	530*
3320*	1600
52850	15460

S

2270*	520*
2640*	1530
42100	15130

S

2670*	570*
3070*	1540
47830	15560

S

NA	NA
NA	NA
NA	NA

S

NA	NA
NA	NA
NA	NA

NA
NA
NA

610*
620*
10280

METERED



350*
430
6240

METERED

NA
NA
NA

560*
680
10780

880
800
13510



METERED

230
290
4020

210
90*
1970

NA
NA
NA

METERED

530*
560
8870

430
190*
3130

S

3500*	1570*
3020*	640*
53520	15020

S

2770*	1500*
2310*	620*
41290	14600

S

3090*	1610*
2680*	680*
46920	14950

S

NA	NA
NA	NA
NA	NA

S

2610*	1480*
2310*	650*
40620	14380



Washington State Department of Transportation



167

4 OF 6



S 222ND ST

S 212TH ST

S 204TH ST

S 194TH ST

S

2780*	520*
3220*	1390
45970	12890

S

1570*	340*
2090	1070
30920	11050

S

2860*	530*
3230*	1470
47710	13680

S

2900*	600*
3300*	1570
52400	15940

S

2860*	530*
3270*	1550
53340	15340

70*
200
1390
NA
NA
NA
METERED

470
460
6960

NA
NA
NA

METERED

440*
520
7260

S

3260*	1490*
3010*	700*
48790	13870

S

2760*	1500*
2510*	700*
42620	14800

S

3030*	1500*
2910*	730*
49370	15540

S

3110*	1490*
2980*	630
49900	14340

S

3050*	1470*
2930*	720*
45080	13650



Washington State  
Department of Transportation



167

5  
OF  
6

S 180TH ST

SW 41ST ST

S 34TH ST

S 23RD ST



S	2510	480*
	2770*	1440
	50740	14040

S	3160	460*
	3500	1340
	63810	13110

S	3200	450*
	3630	1240
	57620	12390

90*
310
2280

390*
400*
6200
METERED

690*
700
10570

E VALLEY HWY

1470*
1620
28170

210*
400
3680

1450*
1630
28070

350*
810
9680



METERED
660
670*
10650

230
180
2120

NA
NA
NA

METERED
380*
450
6050

160
170
2370

S	2570*	1420*
	2260*	710*
	46650	16030

S	2760*	NA
	2750*	NA
	50550	NA

S	4150*
	3510*
	61060

720*
390
7560

710
630
9820

1060*
1030
15280

730*
400
7590

350*
800
9660

150
140*
2140

1730*
1370*
25370

350*
810
9680

S	2350
	2140*
	38220



Washington State Department of Transportation



6 OF 6

S 188TH ST

S 160TH ST

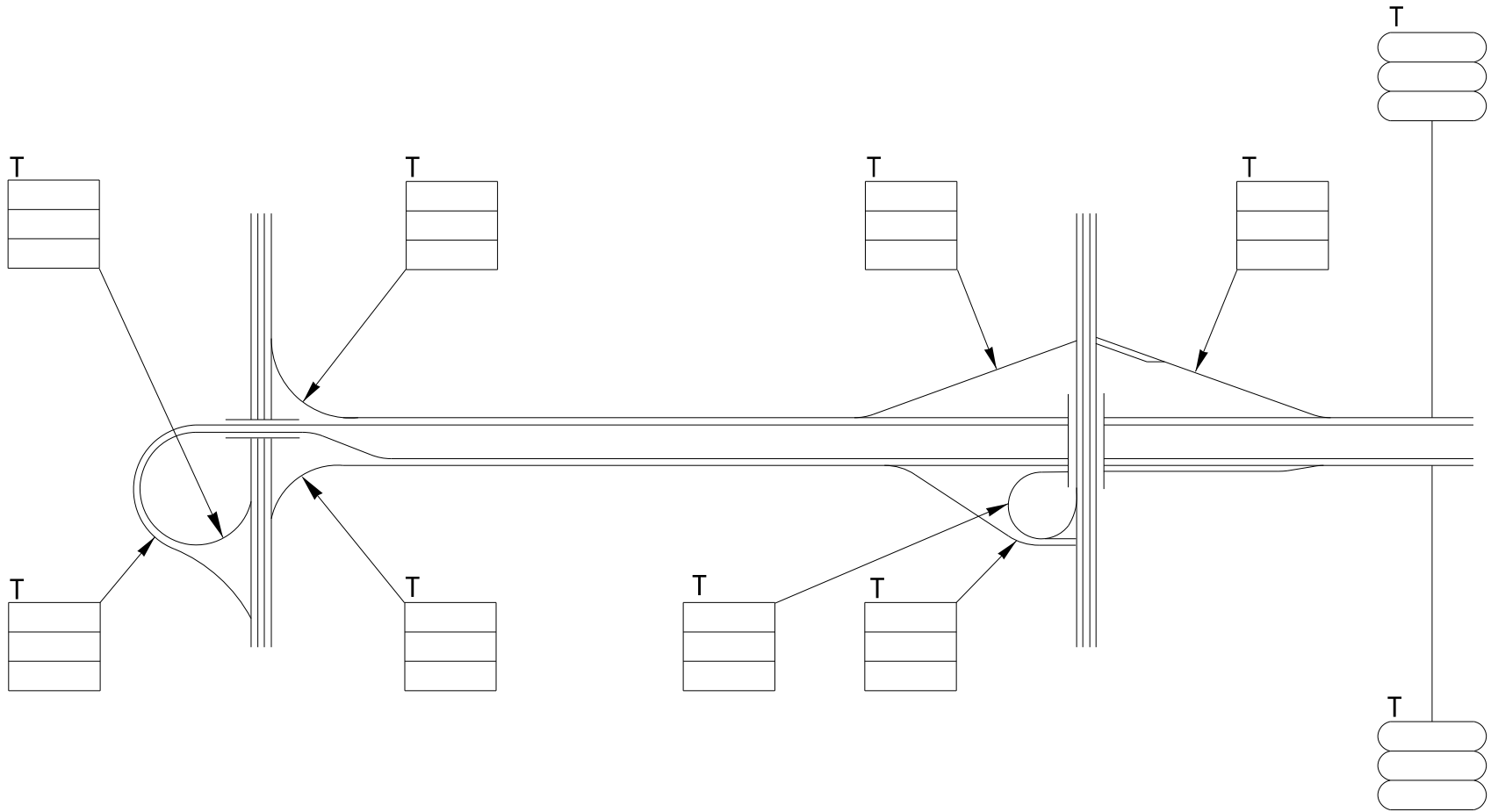

Washington State  
Department of Transportation



1  
OF  
4

SR 518  
SW 148TH ST

SW 146TH ST

SW 128TH ST

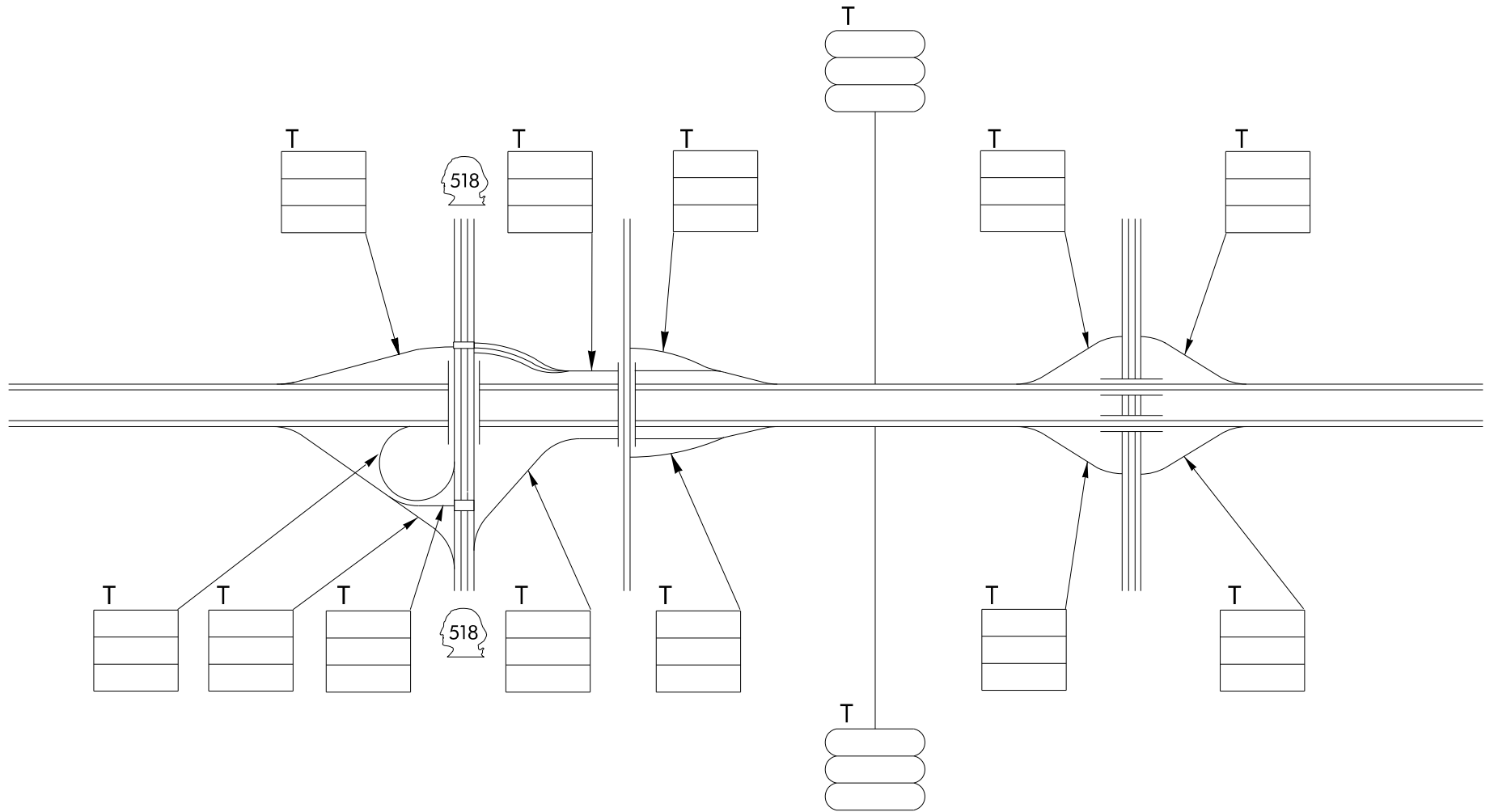

Washington State  
Department of Transportation



2  
OF  
4



GLENDALE WAY S  
5TH AVE S /S 112TH ST

1ST AVE S  
S CLOVERDALE ST

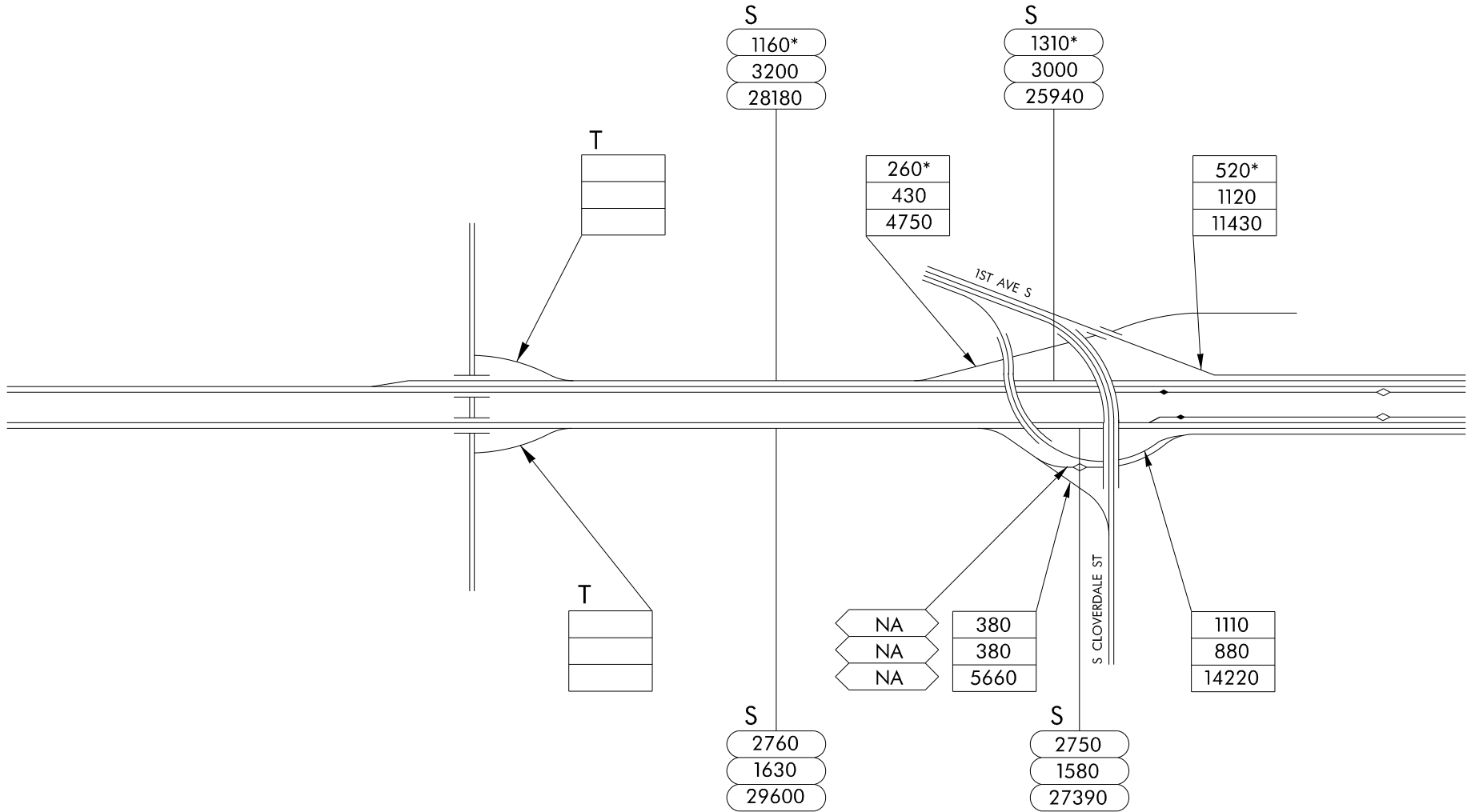

Washington State  
Department of Transportation



3  
OF  
4

SR 509  
S HOLDEN ST



1ST AVE BRIDGE S

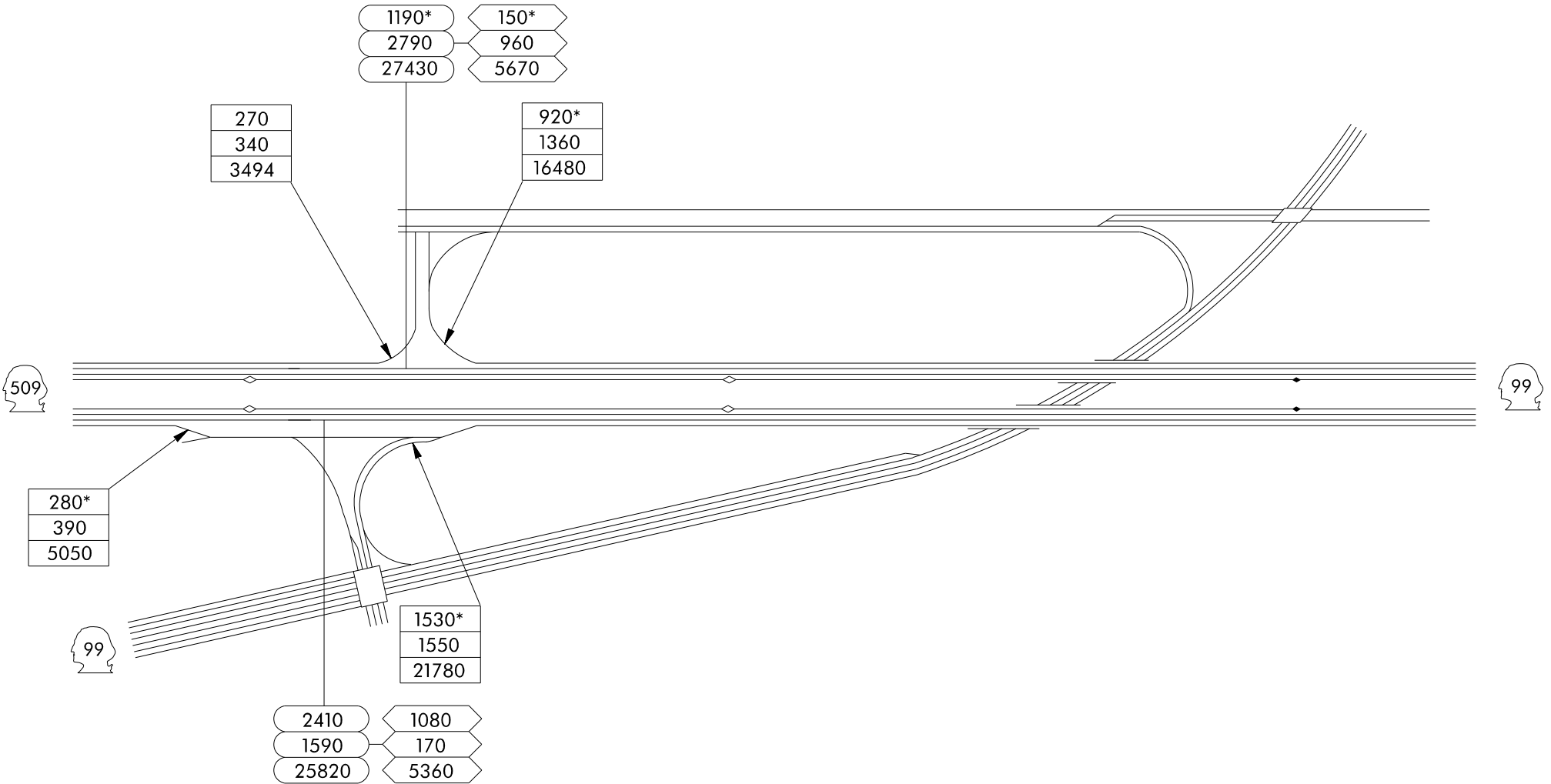

Washington State  
Department of Transportation



1ST AVE S

SR 509

DES MOINES  
MEMORIAL DR S

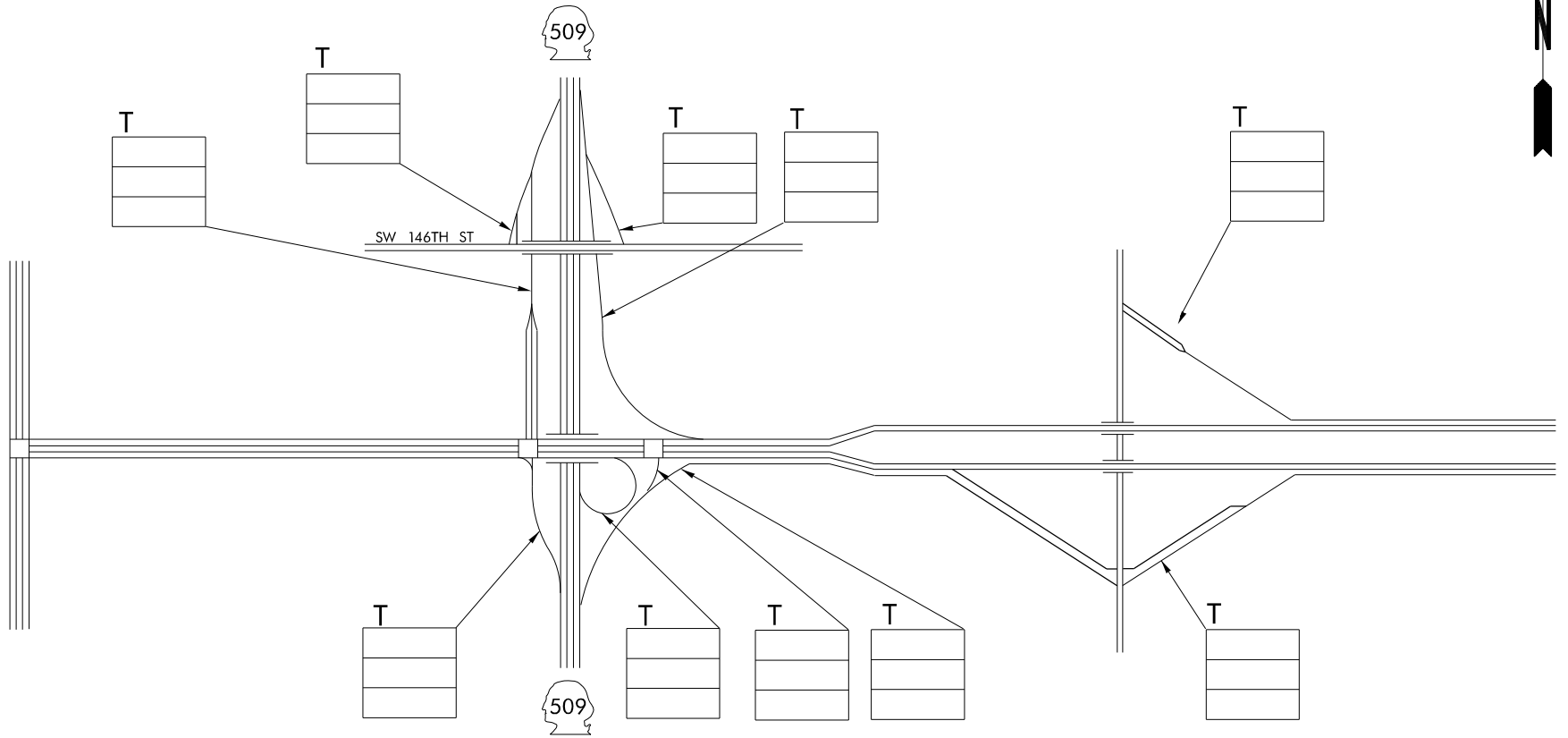

Washington State  
Department of Transportation



1  
OF  
3

S 154TH ST

PERIMETER RD  
SEA-TAC  
ACCESS

SR 99  
PACIFIC  
HWY

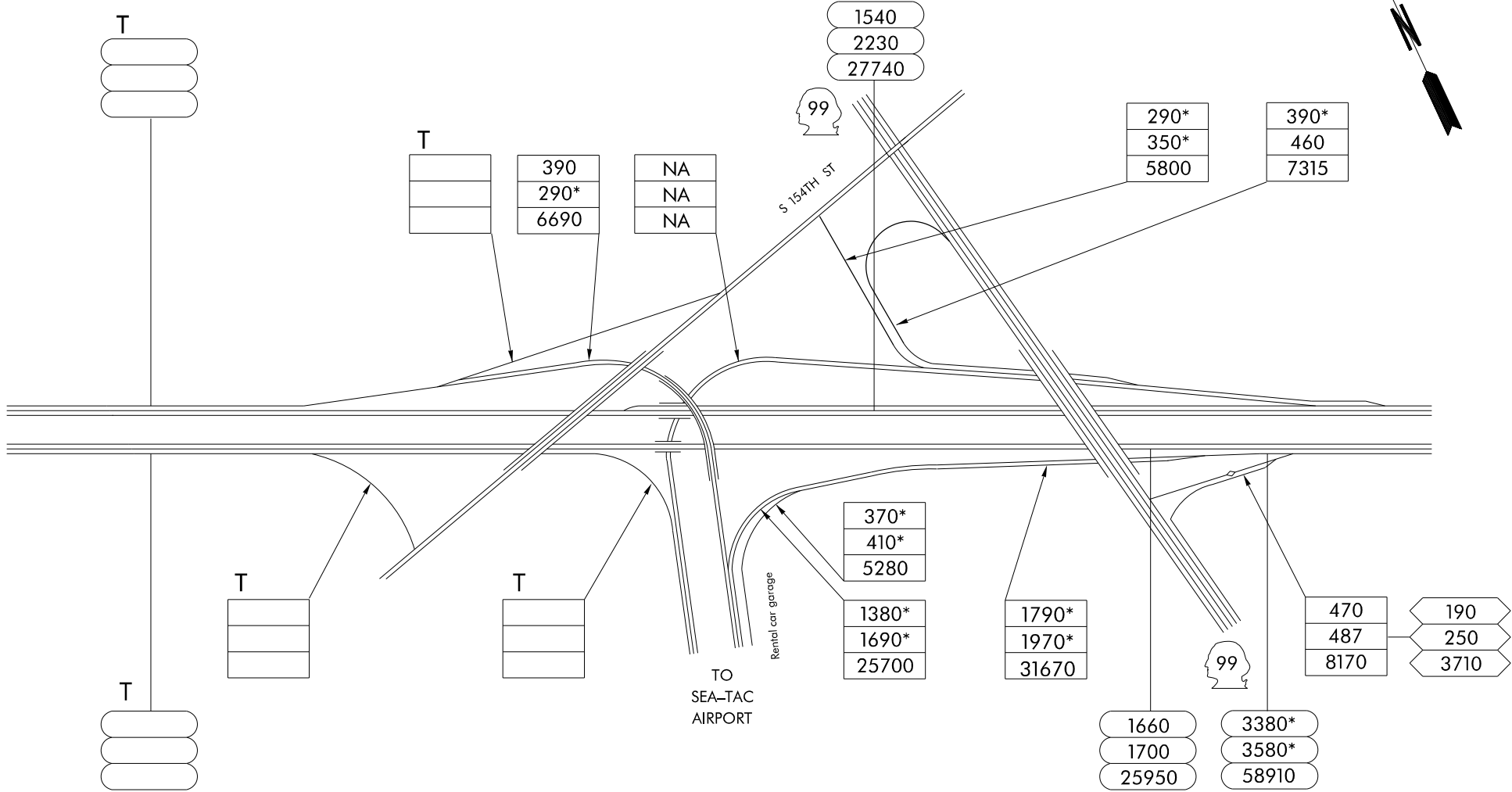
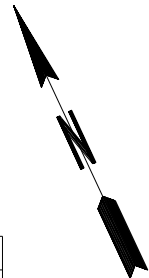

Washington State  
Department of Transportation

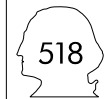

518

2  
OF  
3

42nd AVE S

51ST AVE S

I-5



4130\*  
4560\*  
69410

3520  
3500  
61680

450\*  
700  
7890

930\*  
960\*  
15880

850  
830\*  
15560

1070\*  
1440\*  
19800



2730  
3020\*  
48950

990  
970  
15890

530\*  
590  
7150



1560  
1670\*  
29894

4480\*  
4630\*  
76710

3780\*  
3930\*  
64800



Washington State  
Department of Transportation



3  
OF  
3

I-5  
E ROANOKE ST

SR 513  
MONTLAKE  
BLVD E

LAKE  
WASHINGTON  
BLVD E

EVERGREEN  
POINT  
FLOATING  
BRIDGE

EVERGREEN  
POINT RD

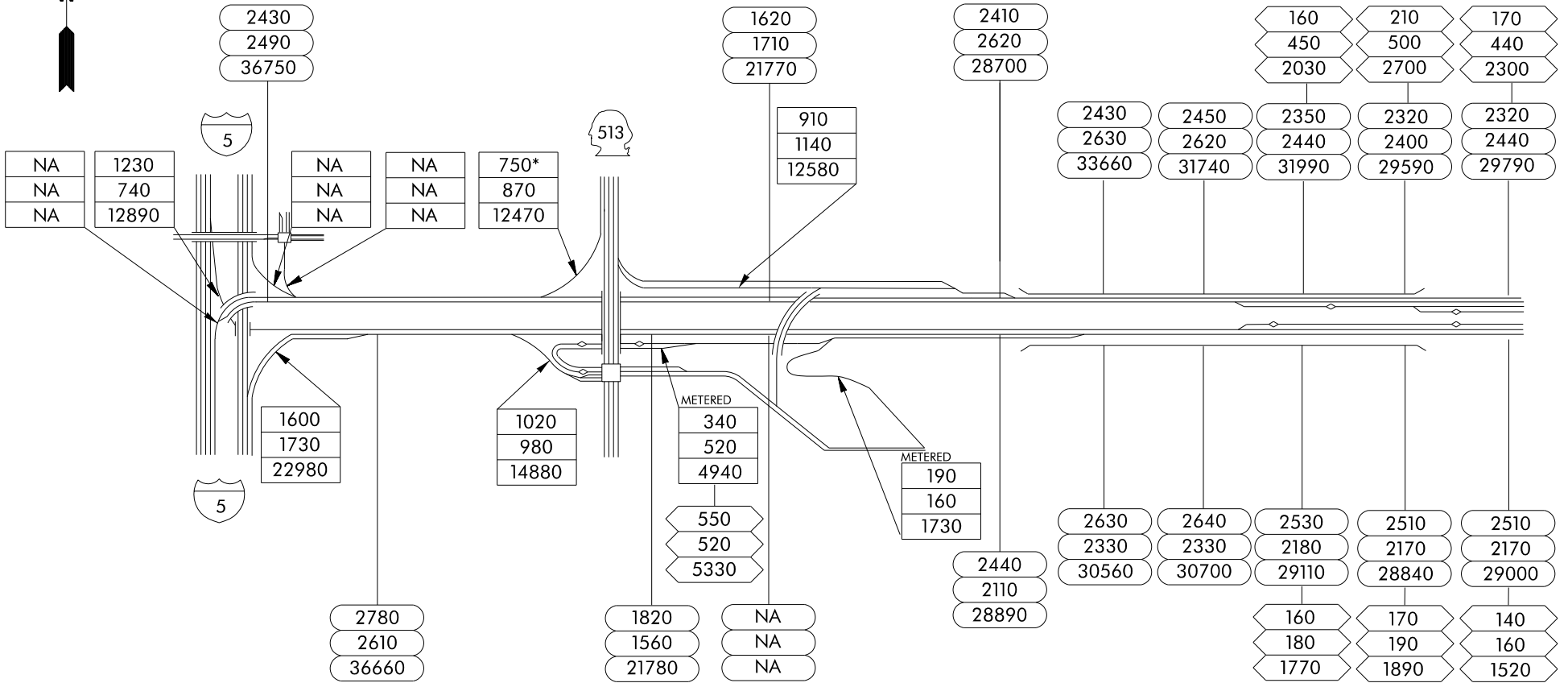

Washington State  
Department of Transportation



1  
OF  
6

84TH AVE NE

85TH AVE NE

88TH AVE NE

91ST AVE NE

92ND AVE NE

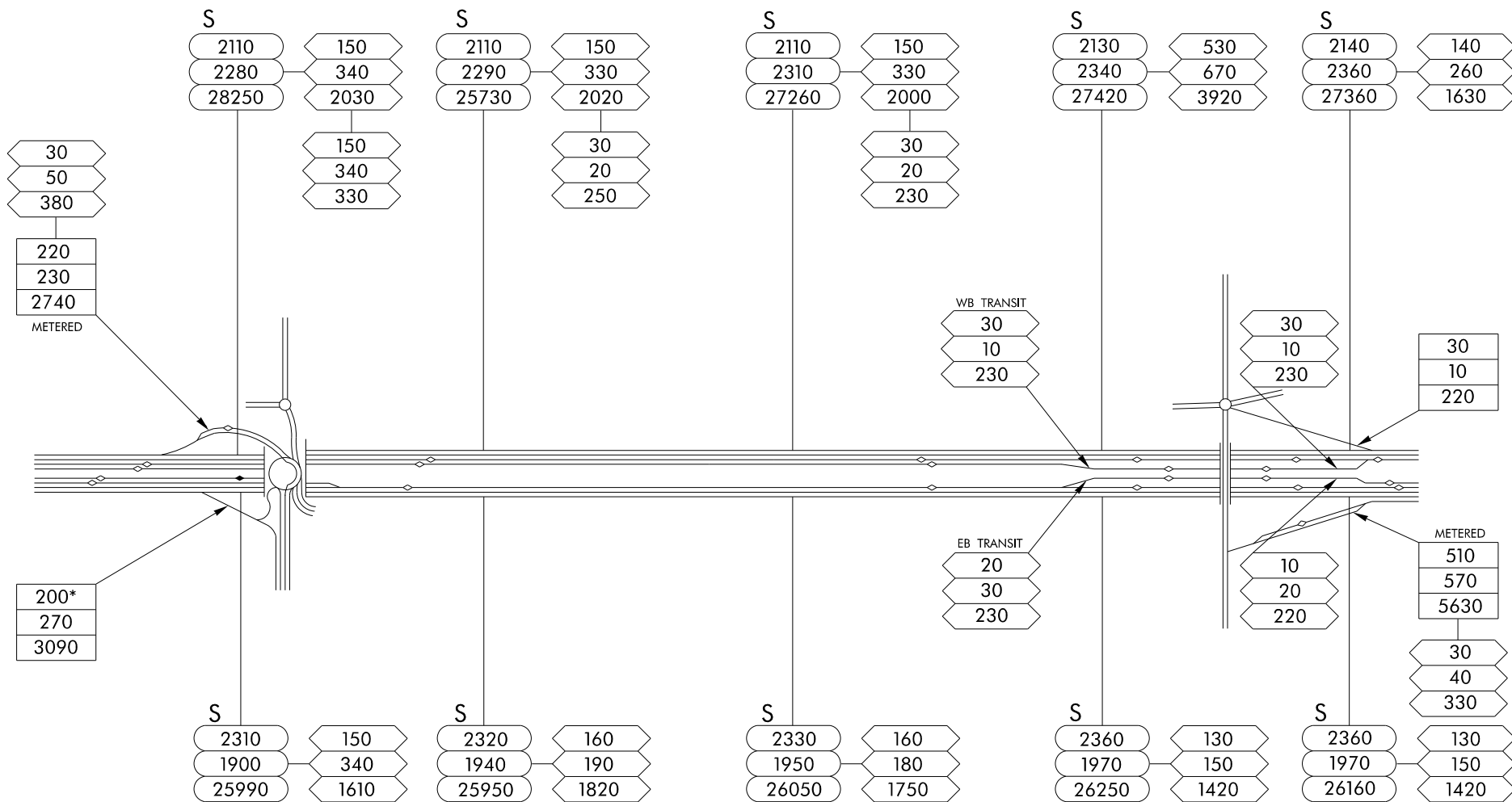

98TH AVE NE

104TH AVE NE  
BELLEVUE WAY

108TH AVE NE 109TH AVE NE

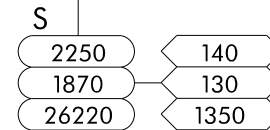
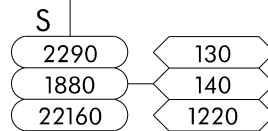
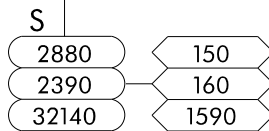
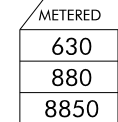
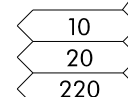
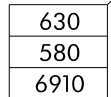
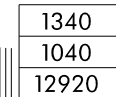
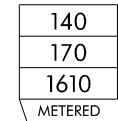
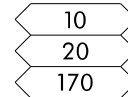
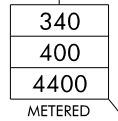
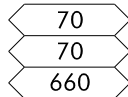
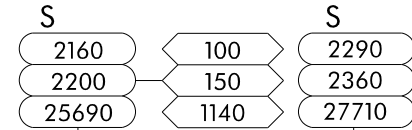
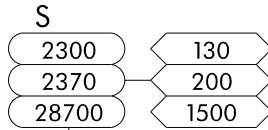
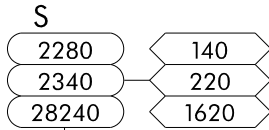

Washington State  
Department of Transportation



520

3  
OF  
6



I-405

124TH AVE NE  
NORTHUP WAY

130TH AVE NE

140TH AVE NE

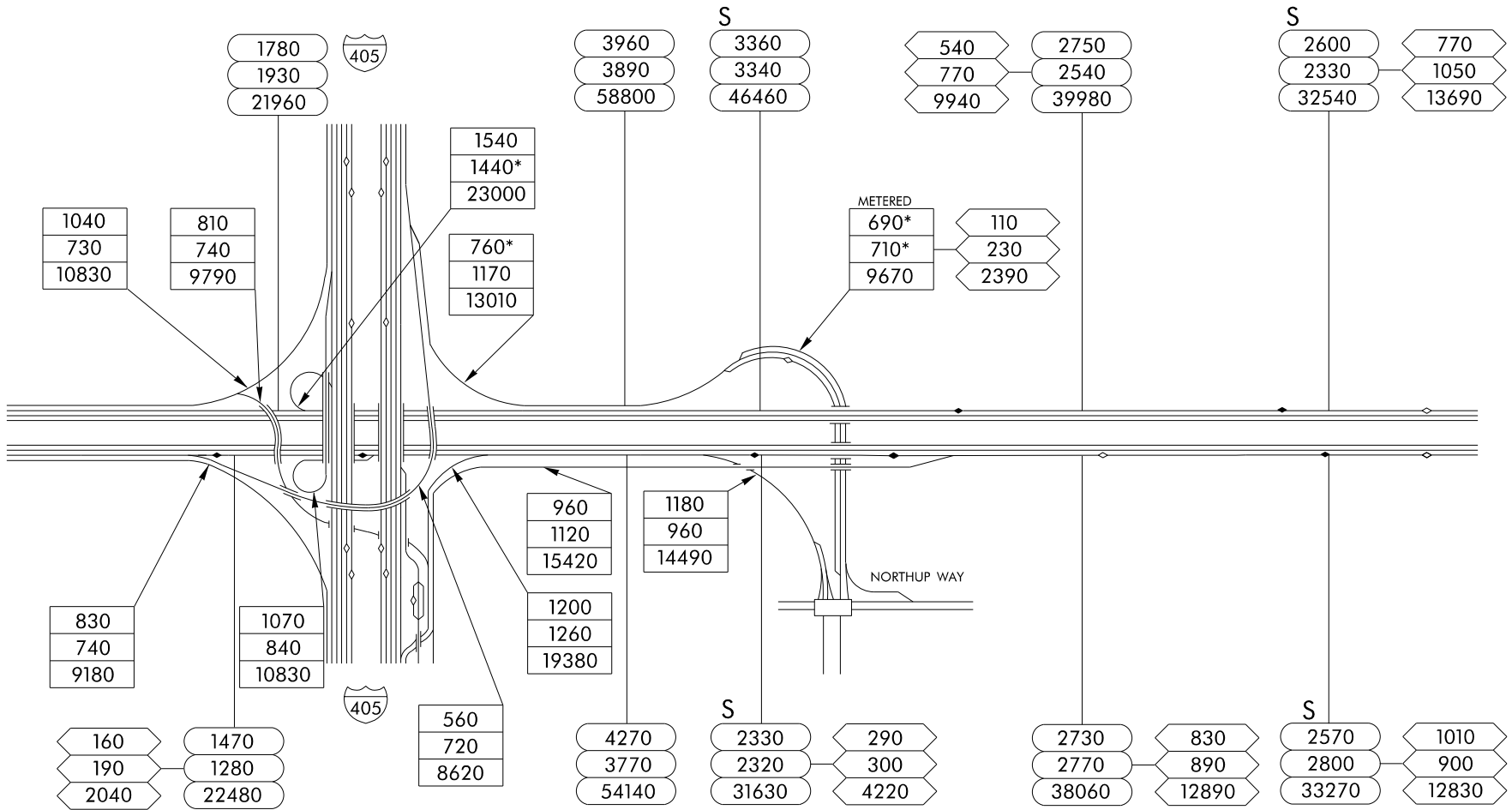

148TH AVE NE

NE 36TH ST

NE 40TH ST

NE 51ST ST

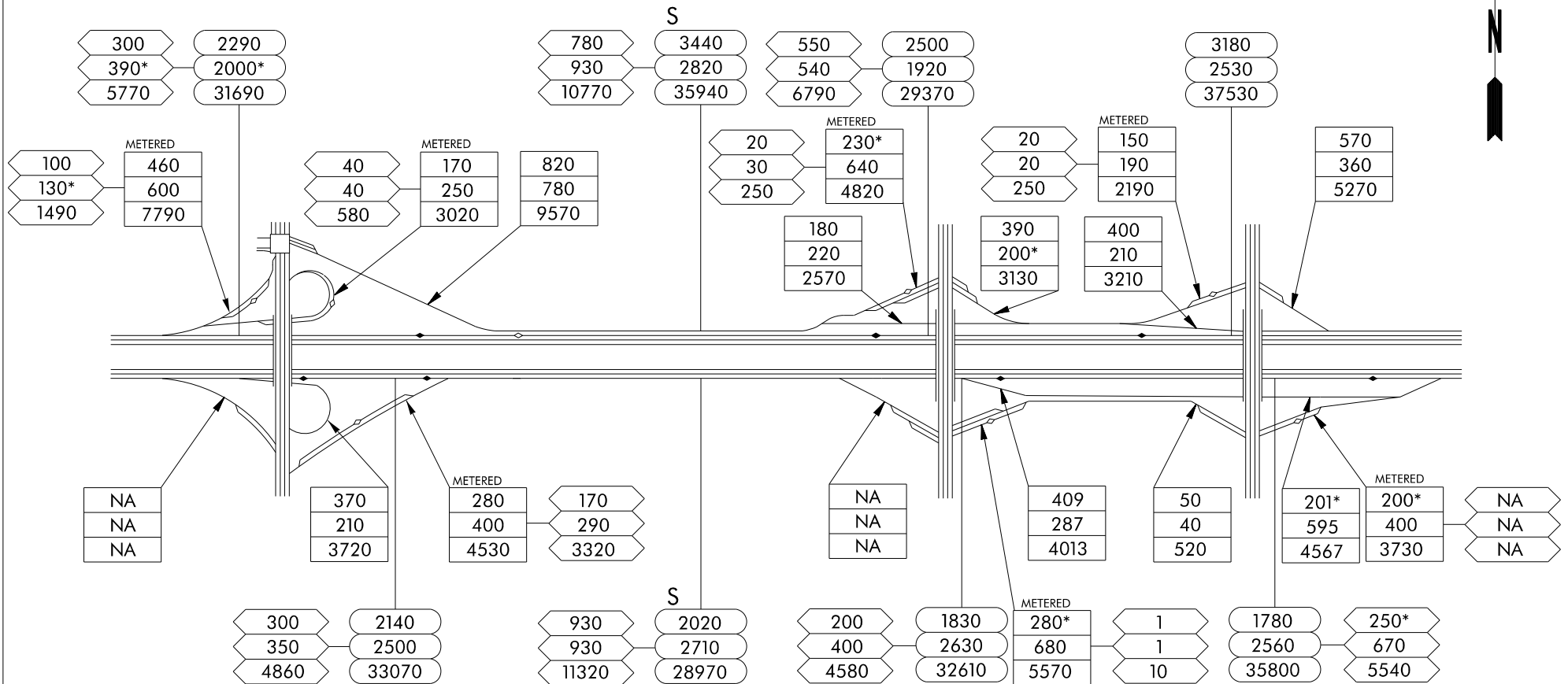

NE 60TH ST

W LAKE  
SAMMAMISH  
PKWY NE  
S

MARYMOOR  
PARK

SR 202  
REDMOND  
WAY

NE 76TH ST



S  
4250  
3150  
46470

3240  
2170  
37270

140  
120  
1390  
1000  
1070  
13890

METERED

3170  
2130  
28480

380  
430  
5200

370  
270  
3210

1020  
860  
12010

METERED

NA  
NA  
NA

280  
300\*  
4030

METERED

S  
1750  
1130  
19450

202

S  
1720  
1140  
14330

640\*  
850  
9860

430  
500  
6060

940\*  
1500  
16980

202

90\*  
110  
1200

S  
2470\*  
4120  
40410

S  
1760\*  
3200  
33720

S  
1740  
3170  
30220

S  
1250  
1930  
21100

S  
1240  
1930  
21100

68th Ave NE

83rd PL NE



840  
960  
13320

1120  
1380  
16670

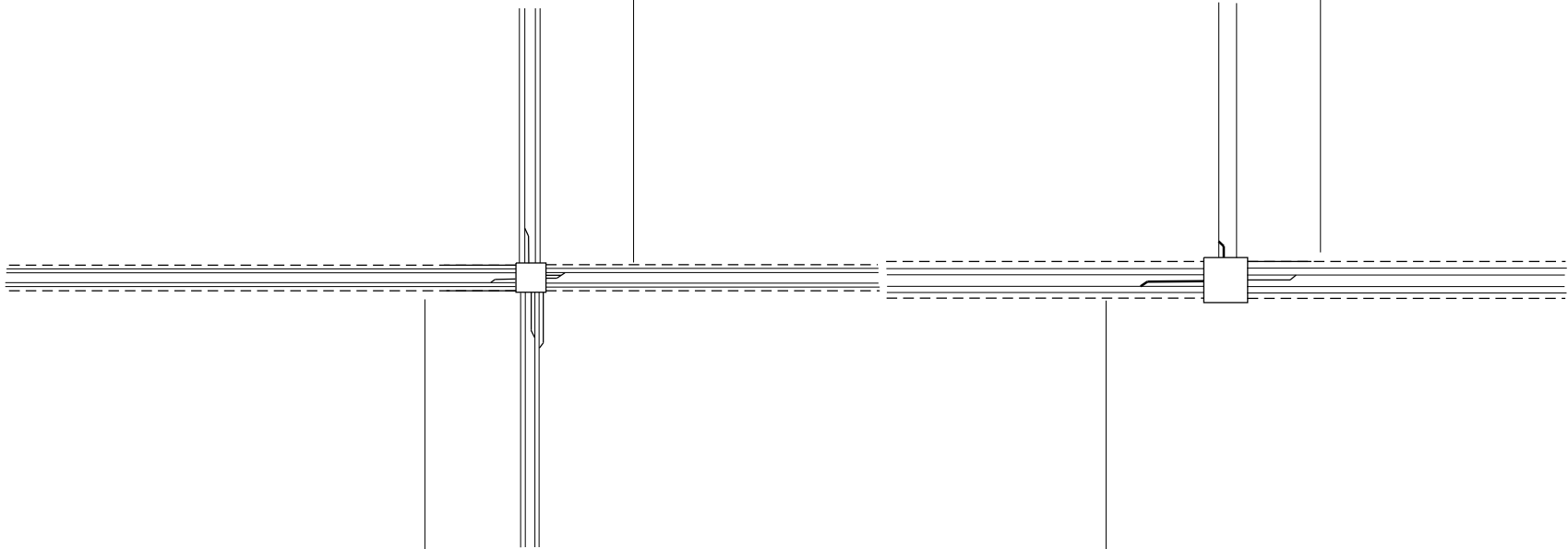

1590  
1630  
22050

1490  
1370  
17990



Washington State  
Department of Transportation



1  
OF  
5

132ND AVE NE  
SR 202



I-405

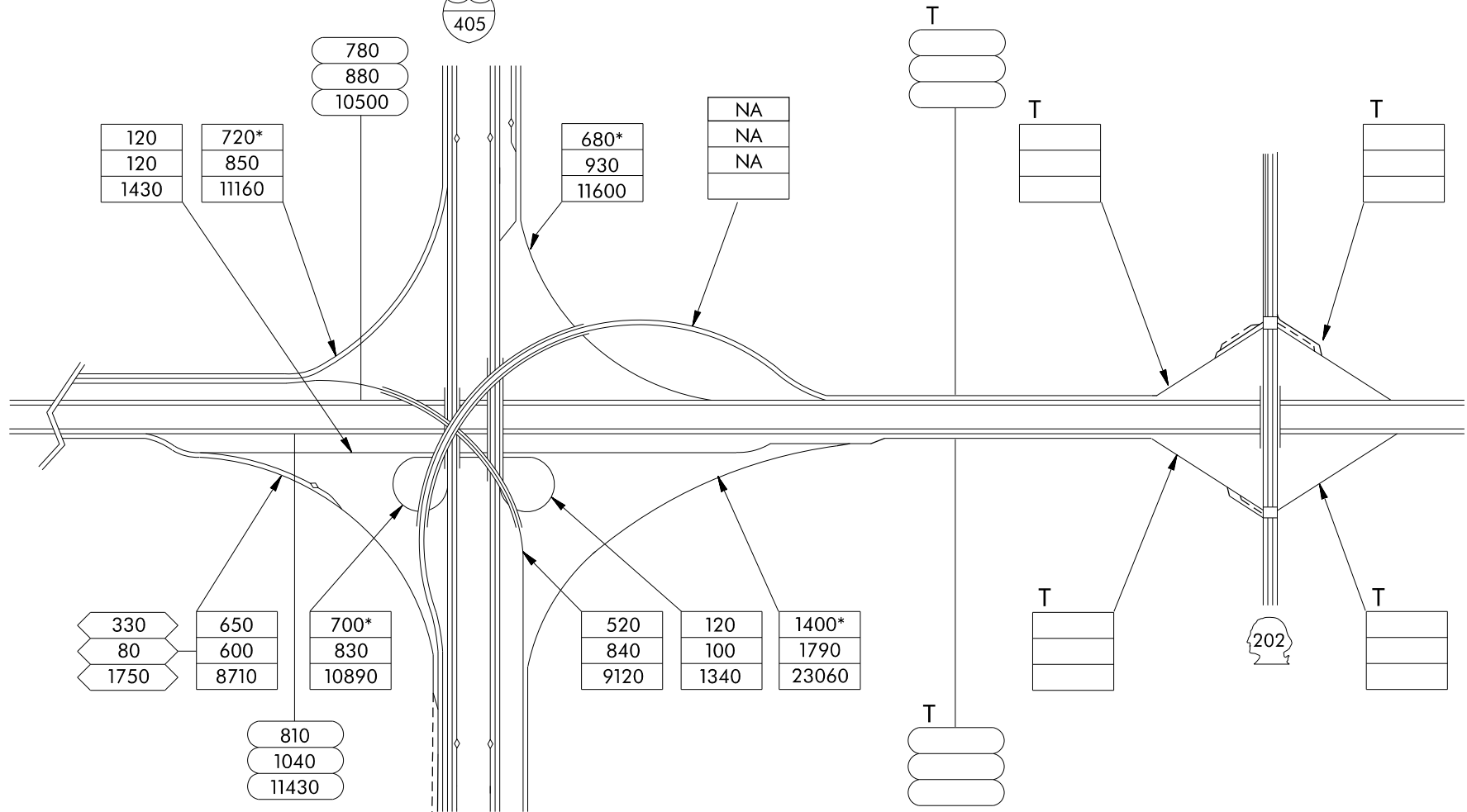

Washington State  
Department of Transportation



522

2  
OF  
5

NE 195TH ST

SR 9  
WOODINVILLE CUT-OFF

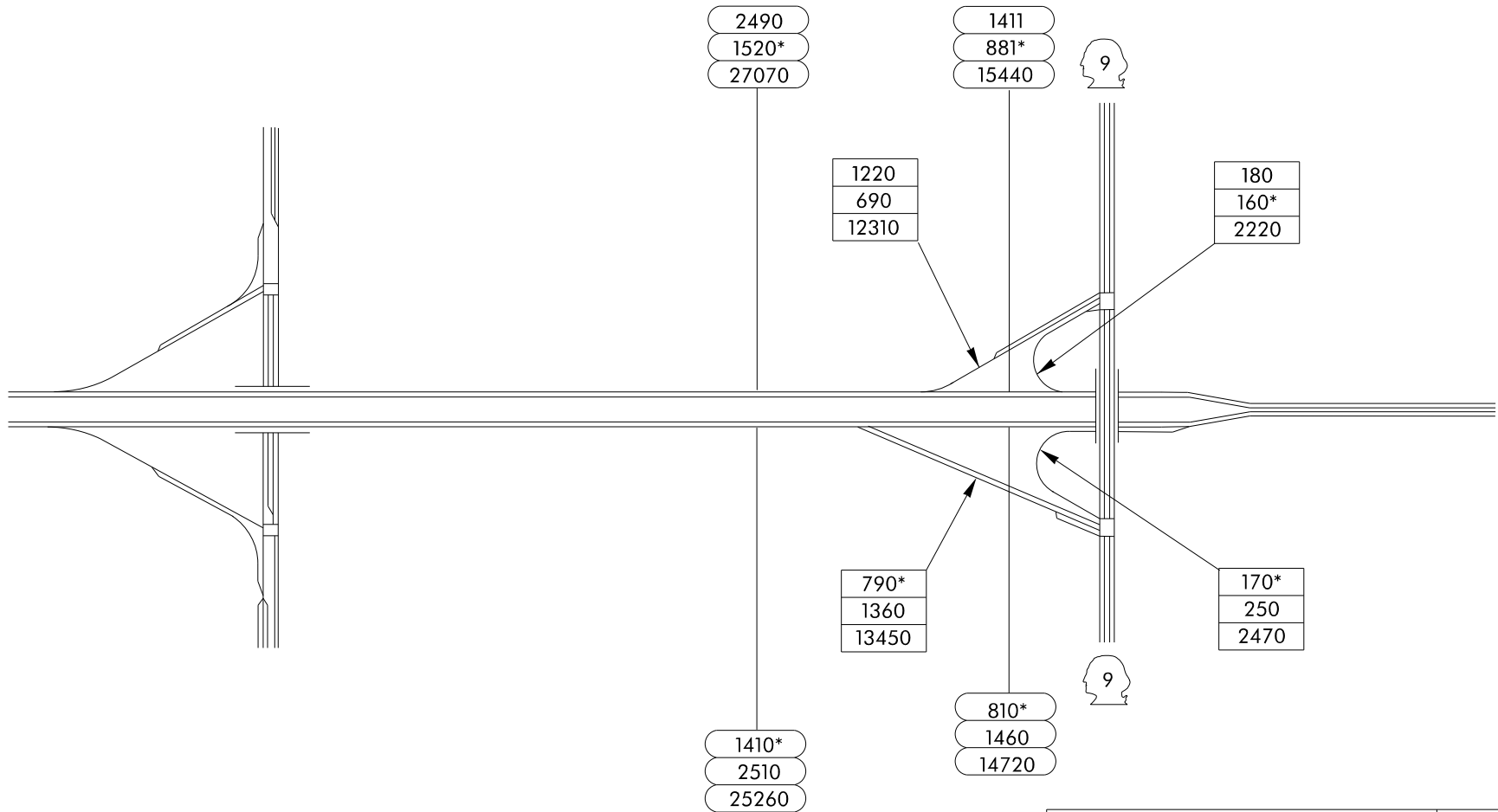

Paradise Lake Rd

Echo Lake Rd  
Fales Rd

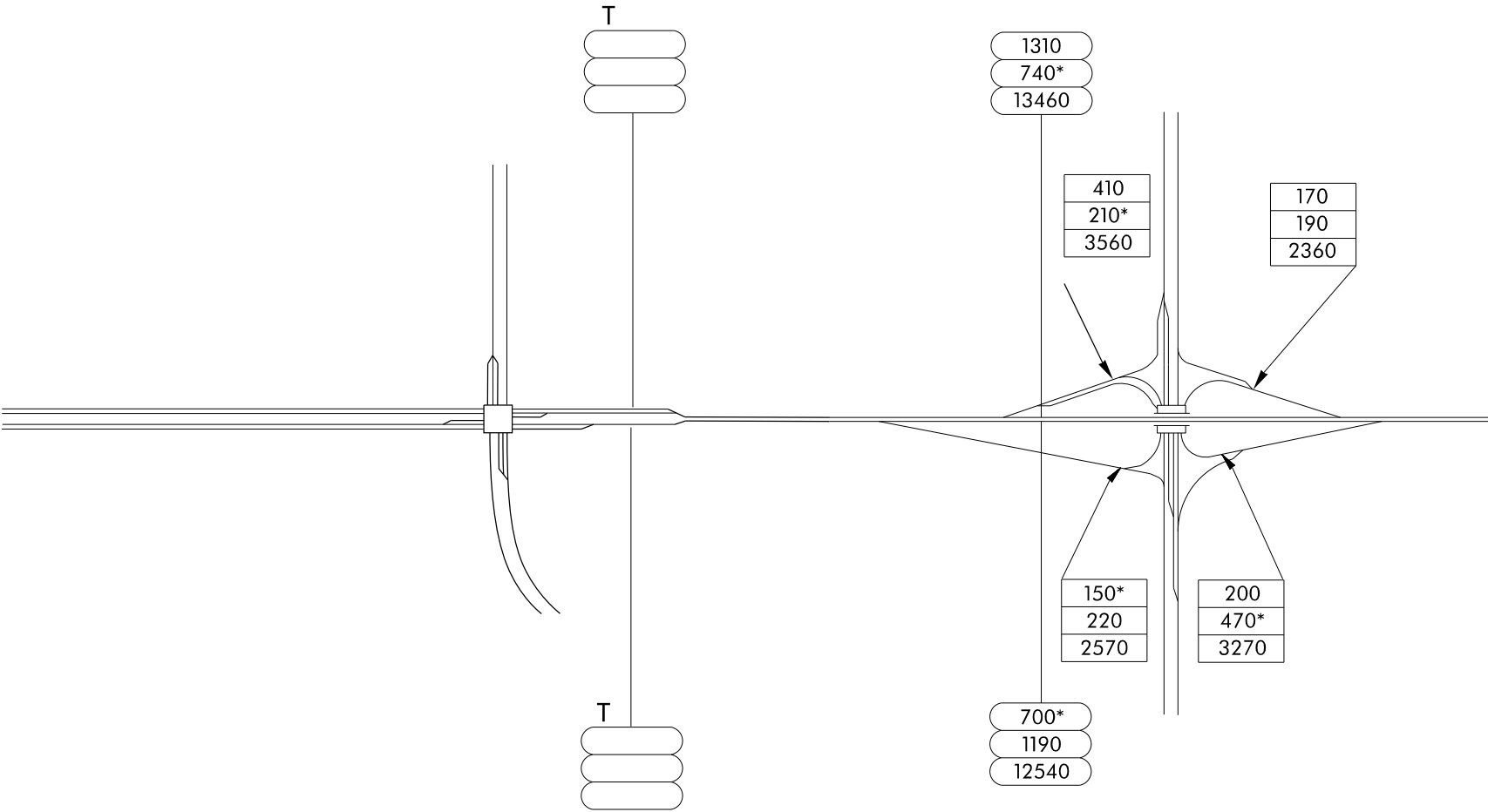

Washington State  
Department of Transportation



522

4  
OF  
5

Snohomish River Bridge

W Main St

US 2

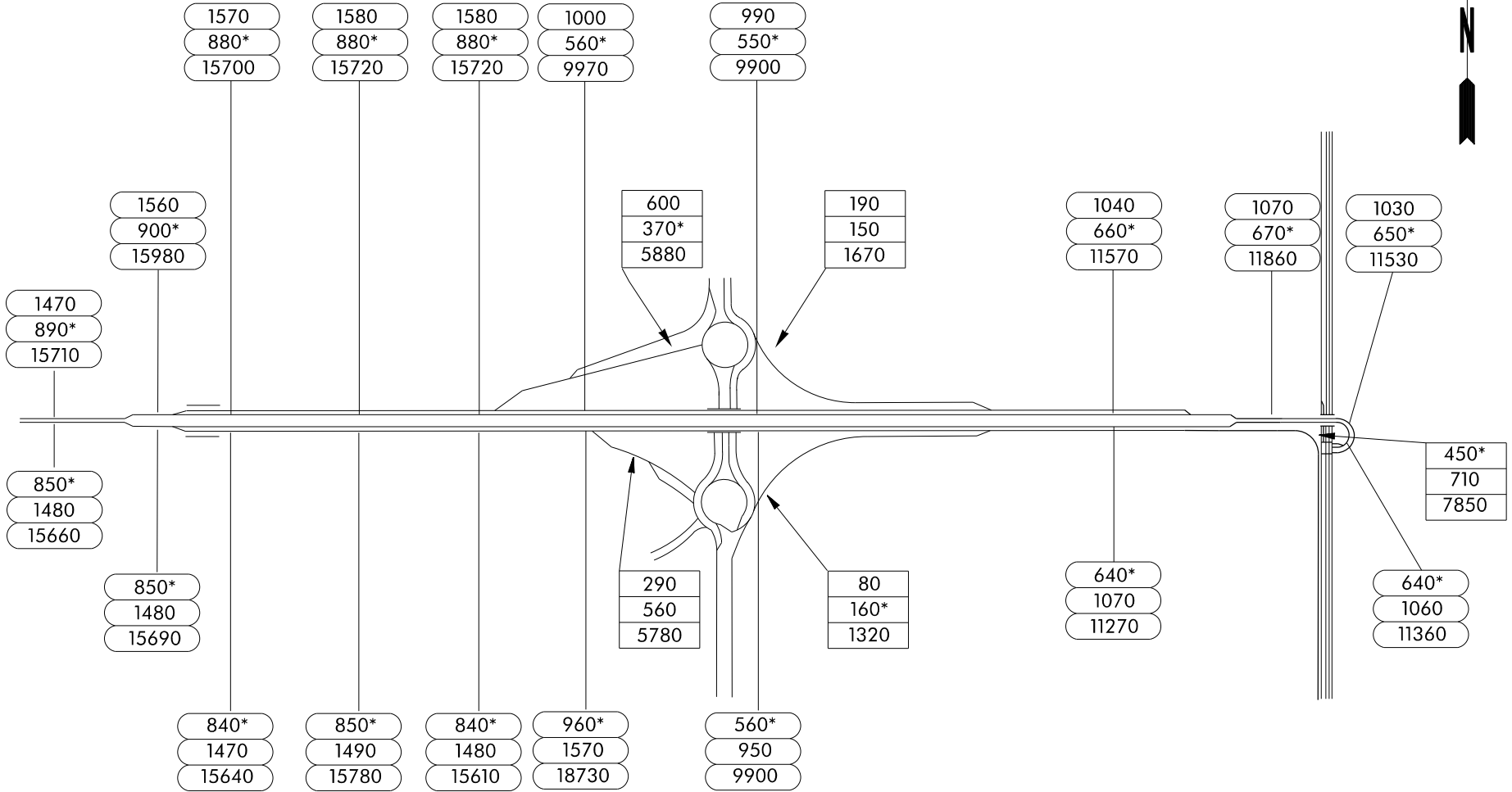

Washington State  
Department of Transportation



522

5  
OF  
5





ALDERWOOD  
MALL PKWY

164TH ST SW

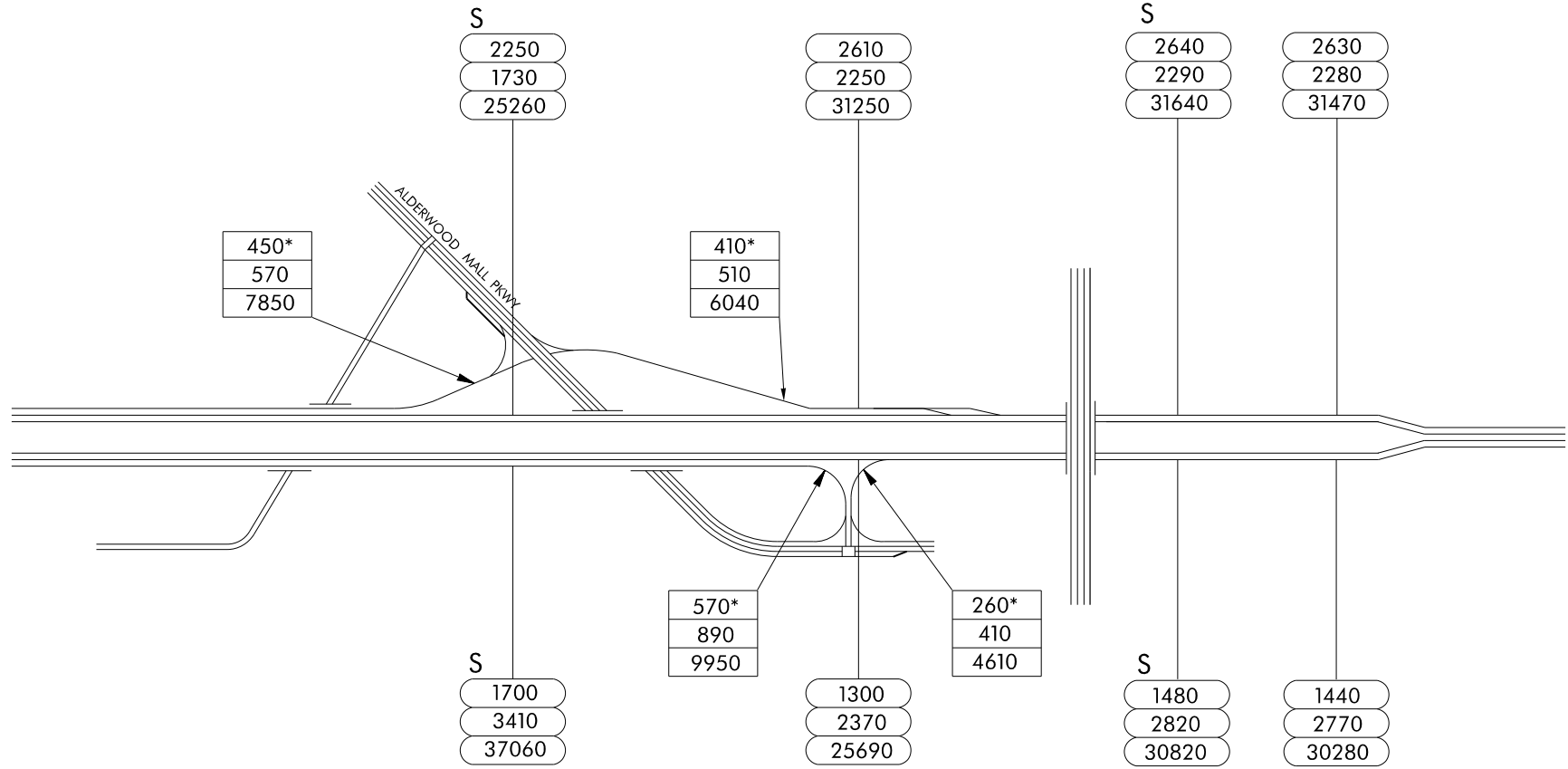

Washington State  
Department of Transportation



525

1  
OF  
2



SR 99  
PACIFIC HWY

LINCOLN WAY

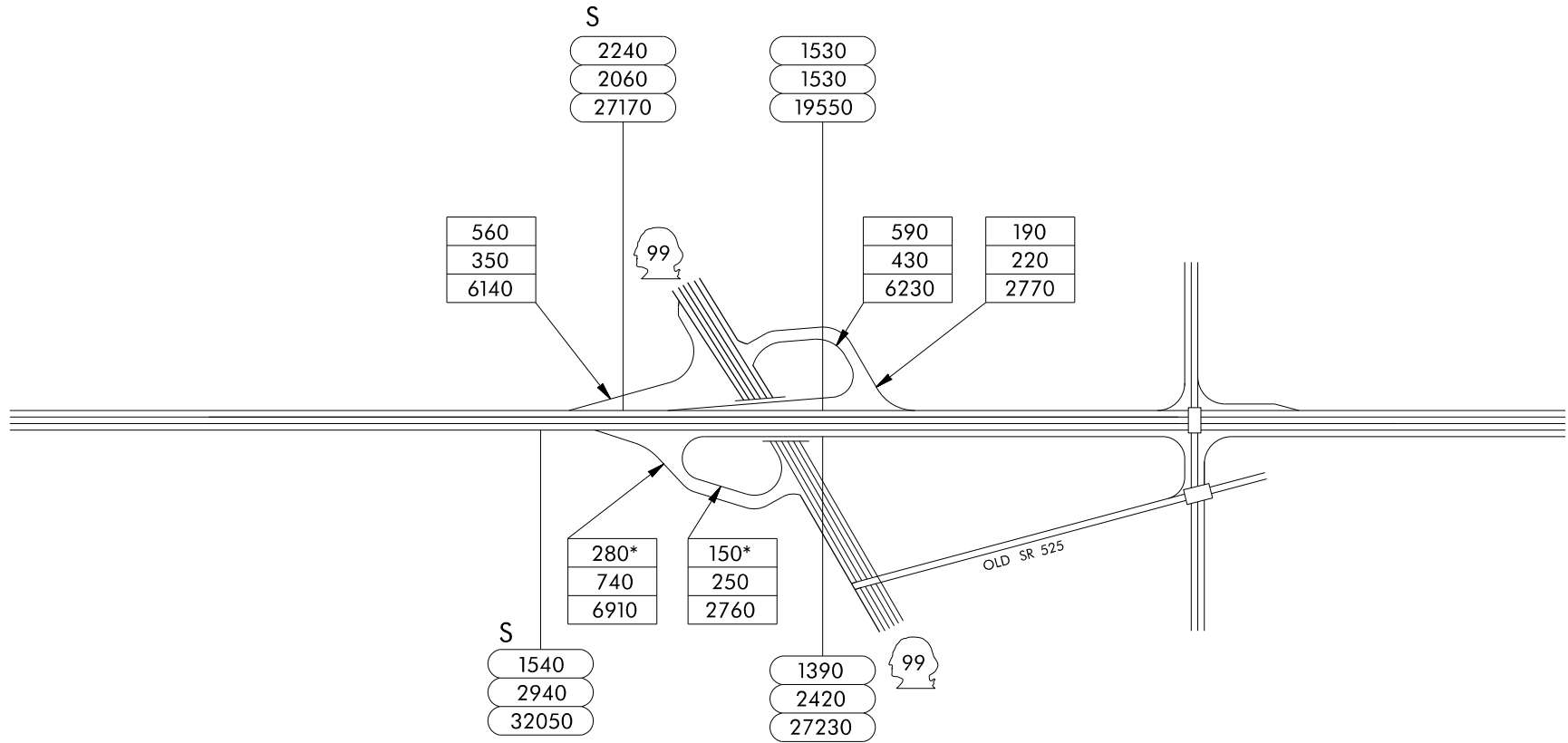

Washington State  
Department of Transportation



2  
OF  
2

AIRPORT RD

SEAWAY BLVD  
20TH AVE W

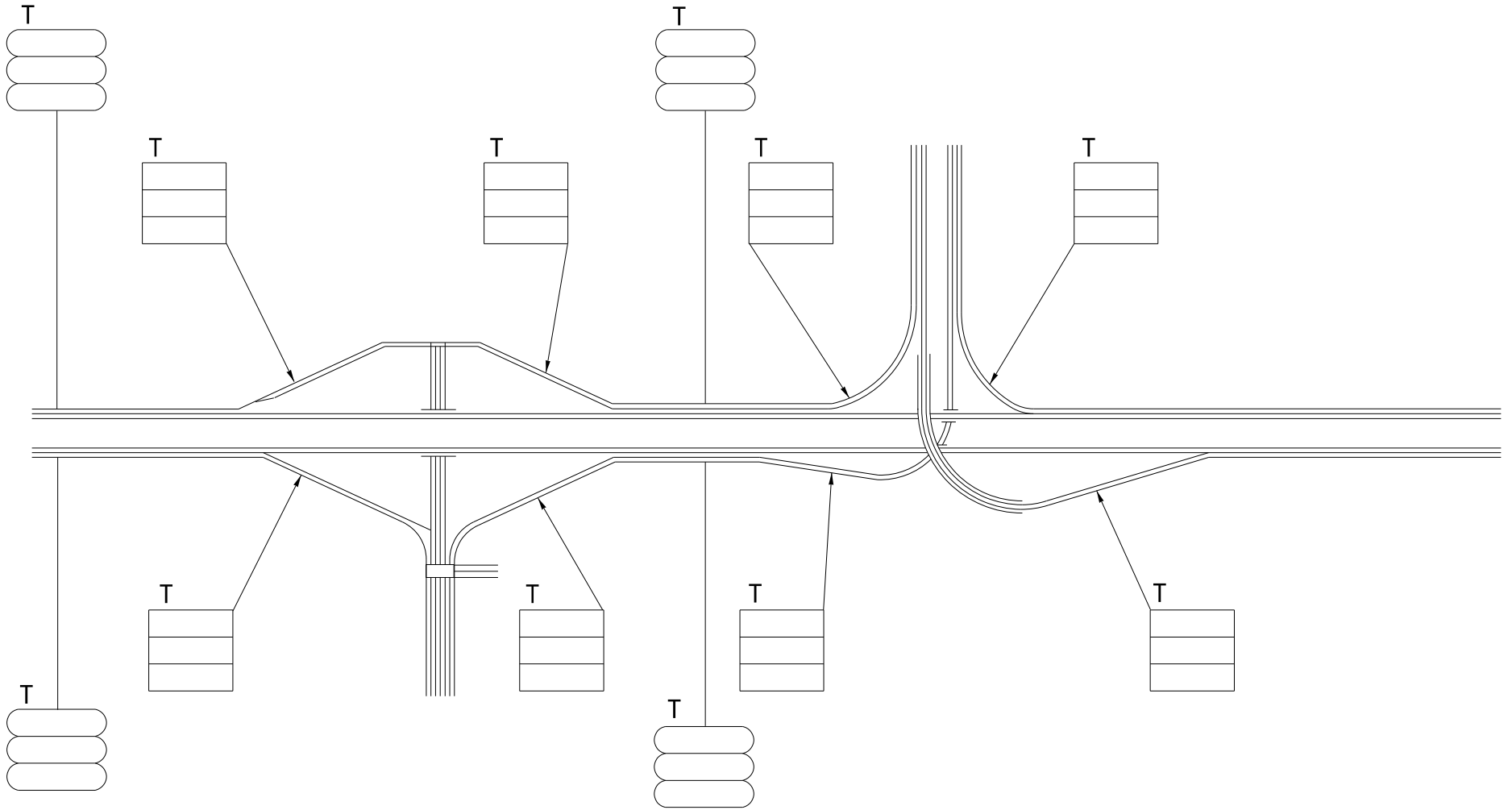

Washington State  
Department of Transportation



526

1  
OF  
2

EVERGREEN WY

I-5

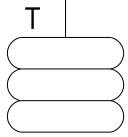
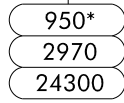
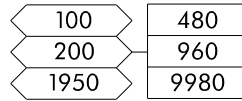
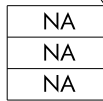
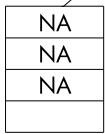
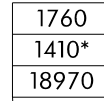
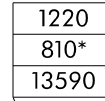
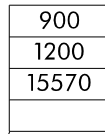
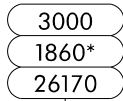
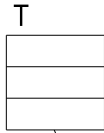
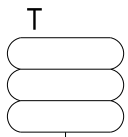

Washington State  
Department of Transportation



2  
OF  
2

I-5

S 133RD ST

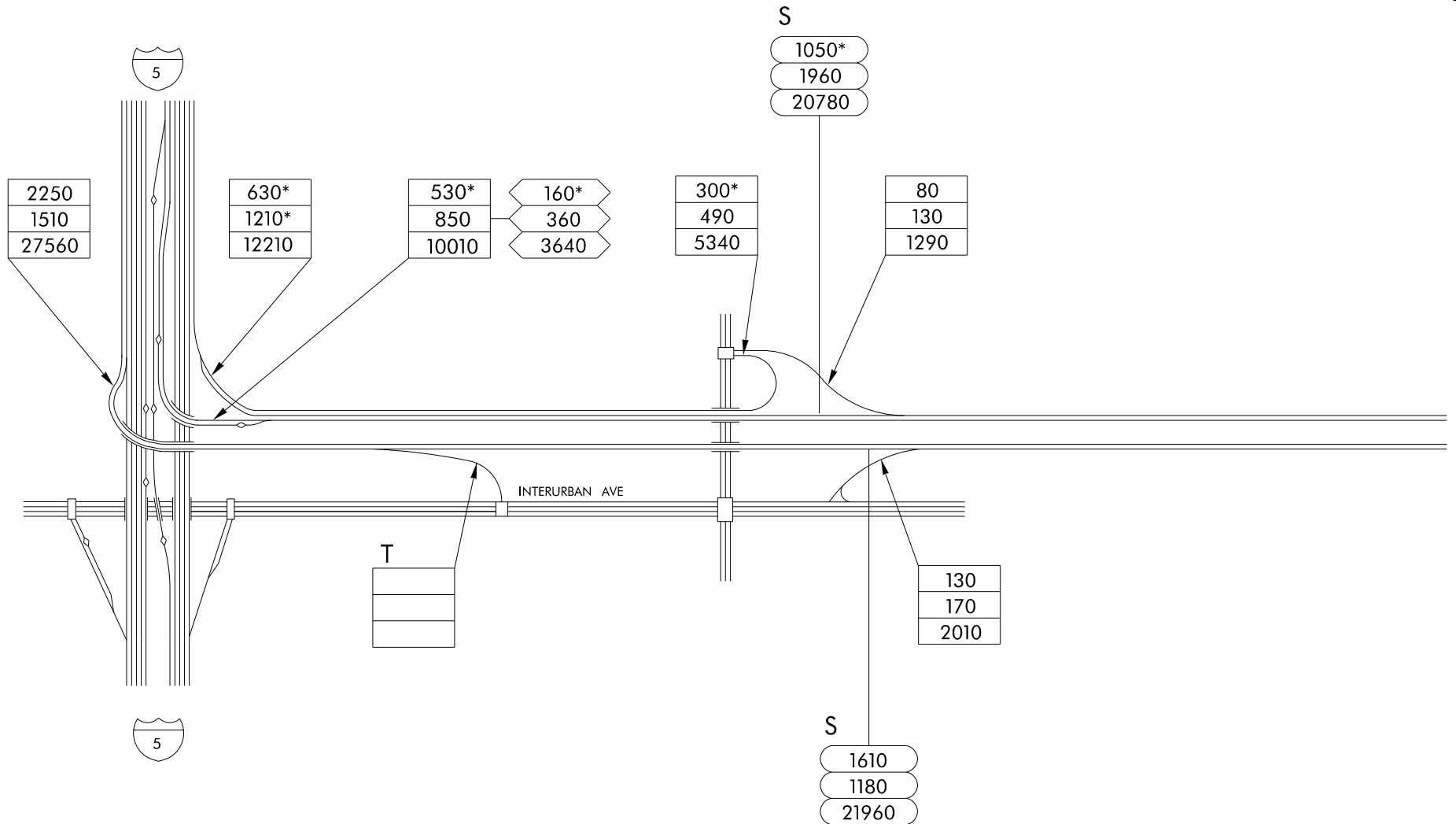
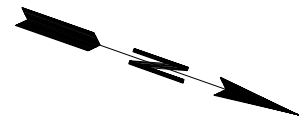

METRO BUS BARN

SR 99  
TUKWILA INTERNATIONAL BLVD

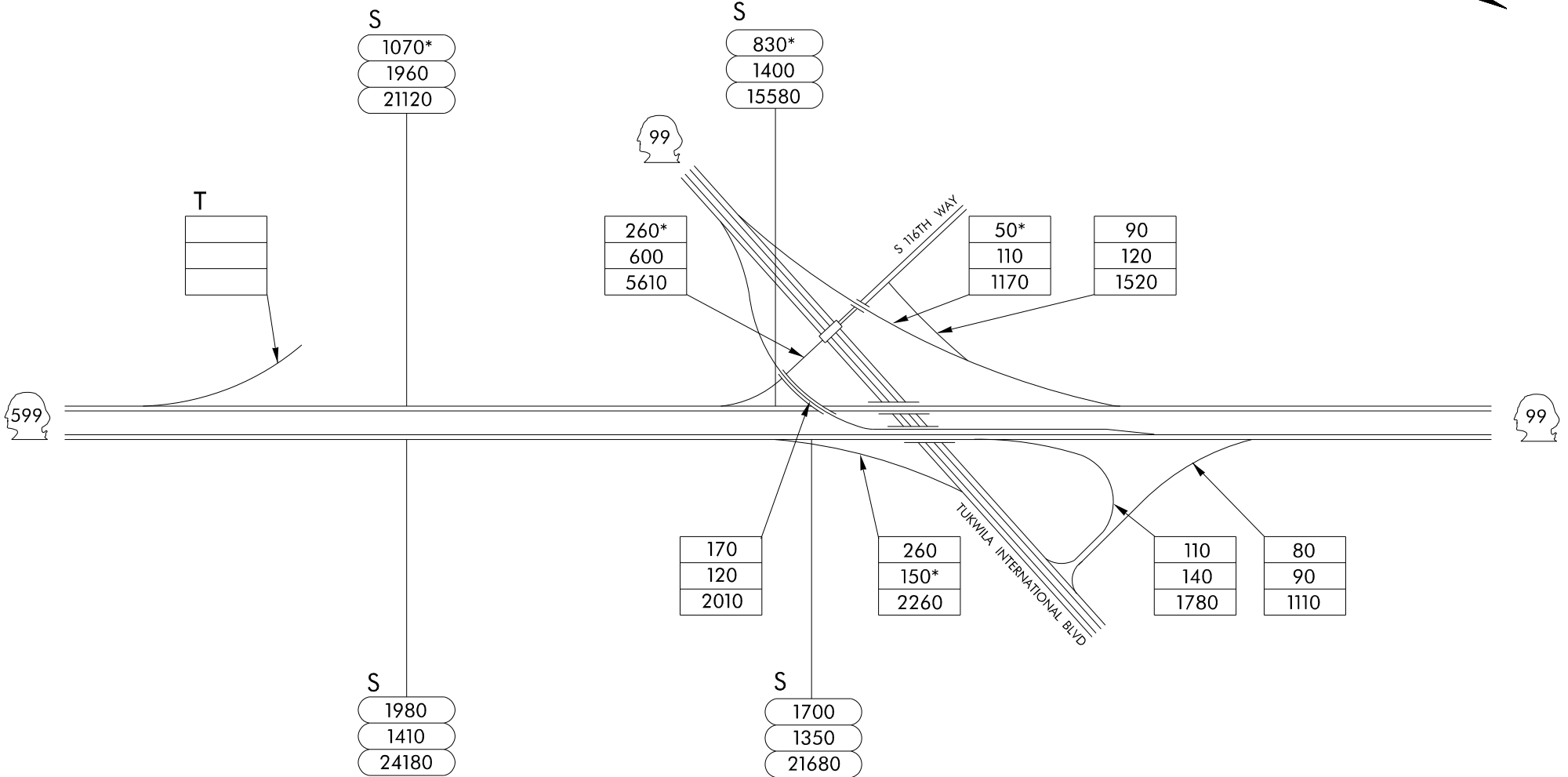
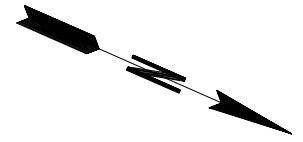

Washington State  
Department of Transportation



2  
OF  
2

Bickford Ave

S

950
940
12660

S

1140
900
13140

SR 9 S

640
840
9950



380*
780
7140

400
240*
4010

170*
310
3050

400
480
6220

30*
60
470

260
360
4350

250
170
2800

S

830
990
12820

S

970
1130
16020

S

660
700
9510



Washington State Department of Transportation



1 OF 2

SR 522

Rice Rd

S  
 850\*  
 950  
 13450

S  
 470  
 460\*  
 6800

S  
 920\*  
 1160  
 14140

S  
 440\*  
 650  
 7020

APPROXIMATELY  
9.25 MILES

APPROXIMATELY  
10.01 MILES





## APPENDIX

For this 2022 traffic volume summary report, the standard AM and PM peak periods are defined as 6:00 to 9:45 AM and 2:30 to 6:45 PM, respectively. Listed below are the ramp, collector distributor (CD), and mainline stations in which the AM and/or PM peak hourly volumes began outside the above peak periods. They are arranged by types and directions.

Route	Sheet No.	Location	AM	PM
US 2	1 of 2	002es00360:_MW_O_1	11:00 AM	-
		002es00411:_ME_O_1	11:00 AM	-
		002es00504:_MW_O_1	-	1:00 PM
		002es00504:_MW_X_1	11:00 AM	-
	2 of 2	002es01429:_MW_Stn	11:00 AM	-
		002es01429:_ME_Stn	11:00 AM	-
		002es02430:_MW__1	-	1:00 PM
		002es02430:_ME__1	11:00 AM	-
I-5	1 of 32	005es13969:_MN_Stn	5:00 AM	1:00 PM
		005es13969:_MSH_5	11:00 AM	-
		005es14015:_MN_Stn	5:00 AM	1:00 PM
		005es14015:_MSH_5	11:00 AM	-
		005es14064:_MN_Stn	5:00 AM	-
		005es14064:_MSH_5	11:00 AM	-
		005es14064:_MN_O_1	10:00 AM	12:00 PM
		005es14126:_MN_Stn	5:00 AM	1:00 PM
		005es14126:_MNH_5	5:00 AM	-
		005es14126:_MS_Stn	-	2:00 PM
	005es14126:_MSH_5	11:00 AM	-	
	2 of 32	005es14150:_MS_O_1	11:00 AM	-
		005es14150:_MS_O_2	-	1:00 PM
		005es14150:AMW_X_1	11:00 AM	-
		005es14176:_MN_Stn	5:00 AM	1:00 PM
		005es14176:_MNH_5	5:00 AM	-
		005es14176:MMS_Stn	11:00 AM	2:00 PM
		005es14176:_MSH_5	11:00 AM	-
		005es14221:MMN_Stn	5:00 AM	1:00 PM
		005es14221:_MNH_5	5:00 AM	-
		005es14221:_MN_P_1	5:00 AM	1:00 PM
		005es14221:_MN_X_1	-	1:00 PM
		005es14221:_MS_Stn	11:00 AM	2:00 PM
		005es14221:_MSH_5	11:00 AM	-
		005es14221:_MS_X_1	11:00 AM	-
		005es14277:_MN_Stn	11:00 AM	1:00 PM
005es14277:_MNH_5		5:00 AM	-	
005es14277:_MS_Stn	11:00 AM	2:00 PM		
005es14277:_MSH_5	11:00 AM	-		
005es14321:_MN_Stn	5:00 AM	1:00 PM		

	005es14321:_MNH_5	5:00 AM	-
	005es14321:_MS_Stn	11:00 AM	2:00 PM
	005es14321:_MSH_5	11:00 AM	-
	005es14364:_MN_Stn	5:00 AM	1:00 PM
	005es14364:_MNH_5	5:00 AM	-
	005es14364:MMS_Stn	11:00 AM	2:00 PM
	005es14364:_MSHStn	11:00 AM	-
	005es14364:_MSHP_1	11:00 AM	7:00 PM
	005es14364:_MS_P_2	-	2:00 PM
	005es14398:MMN_Stn	5:00 AM	1:00 PM
	005es14398:_MNH_5	5:00 AM	-
	005es14398:_MN_P_2	11:00 AM	-
	005es14398:_MN_P_3	-	2:00 PM
	005es14460:_MN_Stn	5:00 AM	1:00 PM
	005es14460:_MNH_5	5:00 AM	-
	005es14460:_MS_Stn	11:00 AM	-
	005es14460:_MSH_5	11:00 AM	-
3 of 31	005es14522:_MN_Stn	5:00 AM	1:00 PM
	005es14522:_MNH_5	5:00 AM	-
	005es14522:_MS_Stn	11:00 AM	-
	005es14575:_MN_Stn	11:00 AM	1:00 PM
	005es14575:_MNH_5	5:00 AM	-
	005es14575:_MS_Stn	11:00 AM	2:00 PM
	005es14575:_MSH_5	11:00 AM	-
	005es14630:_MN_Stn	5:00 AM	1:00 PM
	005es14630:_MNH_5	5:00 AM	-
	005es14630:_MS_Stn	11:00 AM	-
	005es14630:_MSH_5	11:00 AM	-
	005es14676:MMS_Stn	11:00 AM	2:00 PM
	005es14676:_MSH_5	11:00 AM	-
	005es14701:MMN_Stn	5:00 AM	1:00 PM
	005es14701:_MNH_5	5:00 AM	-
	005es14701:_MNBD_1	-	1:00 PM
	005es14701:_MN_P_2	5:00 AM	1:00 PM
	005es14727:DMN_Stn	5:00 AM	1:00 PM
4 of 31	005es14771:_MN_Stn	5:00 AM	1:00 PM
	005es14771:_MNH_5	5:00 AM	-
	005es14771:_MS_Stn	11:00 AM	-
	005es14771:_MSH_5	11:00 AM	-
	005es14807:_MN_Stn	5:00 AM	1:00 PM
	005es14807:_MS_Stn	11:00 AM	-
	005es14807:_MSH_5	11:00 AM	-
	005es14868:_MN_Stn	5:00 AM	1:00 PM
	005es14868:_MNH_5	5:00 AM	-
	005es14868:_MS_Stn	11:00 AM	2:00 PM
	005es14868:_MSH_5	11:00 AM	-

	005es14905:MMS_Stn	11:00 AM	2:00 PM
	005es14905:_MSH__5	11:00 AM	-
	005es14905:_MS_P_1	11:00 AM	-
	005es14905:_MSBD_1	10:00 AM	2:00 PM
	005es14906:MMN_Stn	5:00 AM	1:00 PM
	005es14906:_MNH__5	5:00 AM	-
	005es14906:_MN_P_1	-	1:00 PM
	005es14937:MMN_Stn	5:00 AM	1:00 PM
	005es14937:_MNH__5	5:00 AM	-
	005es14937:_MN_P_1	-	1:00 PM
	005es15036:_MN_Stn	5:00 AM	1:00 PM
	005es15036:_MS_Stn	11:00 AM	2:00 PM
	005es15036:_MSH__5	11:00 AM	-
5 of 31	005es15125:_MN_Stn	5:00 AM	1:00 PM
	005es15125:MMS_Stn	11:00 AM	2:00 PM
	005es15125:_MSH__5	11:00 AM	-
	005es15125:_MS_P_2	11:00 AM	-
	005es15214:_MN_Stn	5:00 AM	1:00 PM
	005es15214:MMS_Stn	11:00 AM	2:00 PM
	005es15214:_MSH__5	11:00 AM	-
	005es15214:_MS_P_2	11:00 AM	-
	005es15280:_MS_Stn	11:00 AM	2:00 PM
	005es15280:_MSH__6	11:00 AM	-
	005es15315:_MN_Stn	-	1:00 PM
	005es15315:_MS_Stn	11:00 AM	2:00 PM
	005es15315:_MSH__6	11:00 AM	-
6 of 31	005es15348:_MN_Stn	-	1:00 PM
	005es15348:_MS_Stn	11:00 AM	2:00 PM
	005es15348:_MSH__7	11:00 AM	-
	005es15410:MMS_Stn	11:00 AM	2:00 PM
	005es15410:_MS_P_2	11:00 AM	1:00 PM
	005es15465:_MN_Stn	-	1:00 PM
	005es15465:_MN_O_2	11:00 AM	1:00 PM
	005es15465:_MS_Stn	11:00 AM	2:00 PM
	005es15465:_MSH__6	11:00 AM	-
	005es15465:_MS_X_1	11:00 AM	-
	005es15465:_MS_X_2	-	12:00 PM
	005es15480:MMN_Stn	-	1:00 PM
	005es15480:_MN_P_1	11:00 AM	-
7 of 31	005es15531:_MN_Stn	-	1:00 PM
	005es15531:_MNH__6	-	1:00 PM
	005es15531:_MS_Stn	11:00 AM	2:00 PM
	005es15531:_MSH__7	11:00 AM	2:00 PM
	005es15569:_MN_Stn	-	1:00 PM
	005es15569:_MNH__5	-	1:00 PM
	005es15569:MMS_Stn	11:00 AM	2:00 PM

	005es15569:_MSH__6	11:00 AM	2:00 PM
	005es15587:MMS_Stn	11:00 AM	2:00 PM
	005es15587:_MS_P_1	11:00 AM	2:00 PM
	005es15608:MMN_Stn	-	1:00 PM
	005es15608:_MNH__5	-	1:00 PM
	005es15608:_MS_Stn	11:00 AM	2:00 PM
	005es15608:_MSH__5	11:00 AM	2:00 PM
	005es15608:_MS_X_1	11:00 AM	-
	005es15652:_MN_Stn	-	1:00 PM
	005es15652:_MNH__5	-	1:00 PM
	005es15652:_MS_Stn	11:00 AM	2:00 PM
	005es15652:_MSH__5	11:00 AM	-
8 of 31	005es15723:MMS_Stn	11:00 AM	2:00 PM
	005es15723:_MSH__5	11:00 AM	-
	005es15723:_MS_P_1	11:00 AM	1:00 PM
	005es15792:MMN_Stn	-	1:00 PM
	005es15792:_MNH__5	-	1:00 PM
	005es15792:_MN_P_1	11:00 AM	2:00 PM
	005es15792:_MN_X_1	-	1:00 PM
	005es15792:_CN_X_1	-	1:00 PM
	005es15792:_MS_Stn	11:00 AM	2:00 PM
	005es15792:_MSH__5	11:00 AM	-
	005es15845:_MNH__5	-	1:00 PM
	005es15845:_MS_Stn	11:00 AM	-
	005es15845:_MSH__5	11:00 AM	-
	005es15892:_MN_Stn	-	1:00 PM
	005es15892:_MNH__5	-	1:00 PM
	005es15892:_MS_Stn	11:00 AM	-
	005es15892:_MSH__5	11:00 AM	-
	005es15957:_MN_Stn	-	2:00 PM
	005es15957:_MNH__5	-	1:00 PM
	005es15957:_MS_Stn	11:00 AM	-
	005es15957:_MSH__5	11:00 AM	-
9 of 31	005es15996:_MNH__5	-	1:00 PM
	005es15996:_MS_Stn	11:00 AM	-
	005es15996:_MSH__5	11:00 AM	-
	005es16064:_MN_Stn	-	1:00 PM
	005es16064:_MNH__5	-	1:00 PM
	005es16064:_MS_Stn	11:00 AM	2:00 PM
	005es16064:_MSH__5	11:00 AM	-
	005es16107:MMS_Stn	11:00 AM	-
	005es16107:_MSH__5	11:00 AM	-
	005es16107:_MS_P_1	11:00 AM	-
	005es16107:_MSHP_2	11:00 AM	-
	005es16120:MMN_Stn	-	1:00 PM
	005es16120:_MNH__5	-	1:00 PM

	005es16120:_MN_P_1	11:00 AM	-
	005es16147:MMN_Stn	5:00 AM	1:00 PM
	005es16147:_MN_P_1	11:00 AM	2:00 PM
	005es16147:_MN_X_1	-	12:00 PM
	005es16186:_MN_Stn	-	1:00 PM
	005es16186:_MS_Stn	11:00 AM	-
	005es16186:_MSH_5	11:00 AM	-
	005es16186:_MS_X_1	-	12:00 PM
10 of 31	005es16272:MMS_Stn	11:00 AM	2:00 PM
	005es16272:_MSH_5	11:00 AM	-
	005es16272:_MS_O_1	11:00 AM	-
	005es16302:_MN_Stn	-	1:00 PM
	005es16302:_MN_O_1	11:00 AM	2:00 PM
	005es16302:_MSH_4	11:00 AM	-
	005es16396:_MS_Stn	-	1:00 PM
	005es16396:_MSH_5	10:00 AM	-
11 of 31	005es16429:MMS_Stn	-	1:00 PM
	005es16429:_MSH_3	10:00 AM	-
	005es16429:_MS_P_2	11:00 AM	2:00 PM
	005es16429:_CS_X_1	-	12:00 PM
	005es16442:_MS_P_1	11:00 AM	-
	005es16466:MMN_Stn	5:00 AM	-
	005es16466:_MN_Stn	-	1:00 PM
	005es16466:_CN_P_2	11:00 AM	2:00 PM
	005es16466:_MS_Stn	-	1:00 PM
	005es16466:_MSH_3	10:00 AM	-
	005es16513:_MN_Stn	11:00 AM	2:00 PM
	005es16513:_MS_Stn	11:00 AM	1:00 PM
	005es16513:_CS_O_1	11:00 AM	-
12 of 31	005es16551:_MN_Stn	-	12:00 PM
	005es16551:_MN_O_2	-	9:00 PM
	005es16551:_MN_X_1	-	1:00 PM
	005es16551:_MS_Stn	11:00 AM	1:00 PM
	005es16551:_MSH_3	11:00 AM	-
	005es16551:_CS_O_1	11:00 AM	-
	005es16583:_MS_Stn	-	12:00 PM
13 of 31	005es16640:_MN_X_1	11:00 AM	-
	005es16640:_MS_Stn	-	12:00 PM
	005es16661:MMS_Stn	-	12:00 PM
	005es16661:_MS_P_1	11:00 AM	2:00PM
	005es16661:_MS_P_2	-	7:00 PM
	005es16701:_MS_Stn	11:00 AM	12:00 PM
14 of 31	005es16732:_MS_Stn	-	12:00 PM
	005es16756:MMS_Stn	11:00 AM	12:00 PM
	005es16802:_MS_Stn	11:00 AM	12:00 PM
	005es16831:_MS_Stn	-	12:00 PM

	005es16885:_MS_Stn	-	12:00 PM
15 of 31	005es16919:_MS_P_2	10:00 AM	8:00 PM
	005es16919:MMS_Stn	-	12:00 PM
	005es16920:_MN_Stn	10:00 AM	-
	005es16942:MMS_Stn	-	12:00 PM
	005es16942:_MS_P_1	-	7:00 PM
	005es16944:MMN_Stn	10:00 AM	-
	005es16944:_MN_P_1	11:00 AM	2:00 PM
	005es16944:_MNHP_1	11:00 AM	-
	005es16977:MMN_Stn	10:00 AM	-
	005es16977:_MNHP_1	11:00 AM	-
	005es16990:MMS_Stn	-	12:00 PM
	005es16990:_MS_P_1	-	12:00 PM
	005es17025:_MN_X_1	11:00 AM	-
	005es17025:_MS_Stn	-	12:00 PM
16 of 31	005es17075:_MS_Stn	-	12:00 PM
	005es17075:_MS_P_1	-	12:00 PM
	005es17131:_MN_Stn	10:00 AM	2:00 PM
	005es17131:_MN_X_1	11:00 AM	-
	005es17131:MMS_Stn	11:00 AM	12:00 PM
	005es17131:_MS_P_2	-	9:00 PM
	005es17131:_MSVP_1	-	12:00 PM
	005es17162:_MS_Stn	-	12:00 PM
	005es17163:MMN_Stn	10:00 AM	2:00 PM
005es17163:_MN_P_1	-	1:00 PM	
005es17163:_MNHP_1	11:00 AM	-	
17 of 31	005es17215:_MS_Stn	11:00 AM	-
	005es17264:_MN_Stn	11:00 AM	-
	005es17264:UMS_Stn	-	2:00 PM
	005es17264:_CS__1	11:00 AM	12:00 PM
	005es17264:_CS_P_1	-	12:00 PM
	005es17264:_CSHP_2	-	12:00 PM
	005es17289:MMN_Stn	11:00 AM	2:00 PM
	005es17289:_MNH_5	11:00 AM	-
	005es17289:_MN_P_2	11:00 AM	2:00 PM
	005es17289:_MNHP_2	11:00 AM	-
	005es17328:_MN_Stn	11:00 AM	2:00 PM
	005es17328:_MNH_6	11:00 AM	-
	005es17375:_MN_Stn	11:00 AM	2:00 PM
005es17375:_MNH_5	11:00 AM	-	
18 of 31	005es17416:_MN_Stn	11:00 AM	2:00 PM
	005es17458:MMN_Stn	11:00 AM	2:00 PM
	005es17458:_MNH_5	11:00 AM	-
	005es17458:_MN_P_2	11:00 AM	1:00 PM
	005es17458:_MNHP_1	11:00 AM	-
	005es17458:_CNHX_1	-	12:00 PM

	005es17508:_MN_Stn	11:00 AM	-
	005es17508:_MNH_5	11:00 AM	-
	005es17551:_MN_Stn	12:00 PM	2:00 PM
	005es17551:_MNH_5	11:00 AM	-
	005es17551:_MS_P_2	5:00 AM	2:00 PM
	005es17551:_MS_X_1	5:00 AM	2:00 PM
	005es17601:_MS_X_1	11:00 AM	-
	005es17627:_MN_P_2	-	1:00 PM
	005es17627:_MNHP_2	11:00 AM	-
	005es17627:_MN_X_1	11:00 AM	-
19 of 31	005es17722:_MN_Stn	11:00 AM	2:00 PM
	005es17722:_MNH_5	11:00 AM	-
	005es17774:_MN_Stn	11:00 AM	2:00 PM
	005es17774:_MNH_4	11:00 AM	-
	005es17774:_CN_O_1	-	12:00 PM
	005es17774:_CN_O_2	12:00 PM	12:00 PM
	005es17774:_CN_X_2	11:00 AM	-
	005es17775:_MS_P_1	10:00 AM	-
	005es17826:MMN_Stn	11:00 AM	2:00 PM
	005es17826:_MNH_4	11:00 AM	-
	005es17826:_MN_P_2	11:00 AM	12:00 PM
	005es17826:_MN_X_1	11:00 AM	-
	005es17826:_MS_X_1	11:00 AM	-
	005es17875:_MNH_4	11:00 AM	-
	005es17926:_MS_P_1	11:00 AM	-
	005es17926:_MSHP_1	-	1:00 PM
	005es17926:_MS_X_1	11:00 AM	-
	005es17927:MMN_Stn	11:00 AM	2:00 PM
	005es17927:_MNH_4	11:00 AM	-
	005es17927:_MN_P_2	11:00 AM	1:00 PM
	005es17927:_MNHP_3	11:00 AM	-
	005es17976:_MN_Stn	11:00 AM	2:00 PM
	005es17976:_MNH_5	11:00 AM	-
20 of 31	005es18017:_MN_Stn	11:00 AM	2:00 PM
	005es18017:_MNH_5	11:00 AM	-
	005es18066:_MN_Stn	11:00 AM	2:00 PM
	005es18066:_MNH_4	11:00 AM	-
	005es18066:_MN_X_2	11:00 AM	-
	005es18066:_MNHX_1	11:00 AM	-
	005es18106:_MS_P_1	11:00 AM	2:00 PM
	005es18115:_MN_Stn	11:00 AM	-
	005es18115:_MNHStn	-	2:00 PM
	005es18115:_MN_X_1	11:00 AM	12:00 PM
	005es18156:MMN_Stn	11:00 AM	2:00 PM
	005es18156:_MNH_4	11:00 AM	-
	005es18156:_MN_P_1	11:00 AM	-

	005es18170:_MNH_5	11:00 AM	-
	005es18170:_MN_P_1	11:00 AM	1:00 PM
	005es18204:_MN_Stn	11:00 AM	2:00 PM
	005es18204:_MNH_5	11:00 AM	-
	005es18204:_MN_X_1	11:00 AM	-
	005es18204:_MS_O_2	11:00 AM	-
	005es18211:_MS_P_3	11:00 AM	-
	005es18264:_MNH_4	11:00 AM	-
	005es18264:_MN_O_2	11:00 AM	1:00 PM
21 of 31	005es18322:_MN_Stn	11:00 AM	2:00 PM
	005es18322:_MNH_5	11:00 AM	-
	005es18382:_MS_P_3	11:00 AM	-
	005es18406:_MNH_4	11:00 AM	-
	005es18406:_MN_P_1	-	1:00 PM
	005es18507:_MNH_4	11:00 AM	-
	005es18548:_MNH_4	11:00 AM	-
22 of 31	005es18577:_MNH_4	11:00 AM	-
	005es18635:_MN_X_1	11:00 AM	-
	005es18707:_MNH_4	11:00 AM	-
	005es18739:_MNH_4	12:00 PM	-
23 of 31	005es18789:_MS_O_1	10:00 AM	12:00 PM
	005es18789:_MS_O_2	10:00 AM	12:00 PM
	005es18797:_MNH_4	11:00 AM	-
	005es18846:_MNH_5	11:00 AM	-
	005es18900:_MN_Stn	11:00 AM	2:00 PM
	005es18900:_MNH_4	11:00 AM	-
	005es18900:_MN_X_1	11:00 AM	-
	005es18931:_MN_P_2	11:00 AM	1:00 PM
	005es18932:MMN_Stn	11:00 AM	2:00 PM
	005es18932:_MNH_4	11:00 AM	-
	005es18944:_CS_X_1	5:00 AM	1:00 PM
	005es18998:_MN_Stn	11:00 AM	2:00 PM
	005es18998:_MNH_5	11:00 AM	-
24 of 31	005es19040:_MNH_5	11:00 AM	-
	005es19090:_MNH_5	11:00 AM	-
	005es19139:_MNH_5	11:00 AM	-
25 of 31	005es19188:_MNH_5	11:00 AM	-
	005es19226:MMS_Stn	-	1:00 PM
	005es19226:_MS_P_1	11:00 AM	-
	005es19255:MMS_Stn	-	1:00 PM
	005es19255:_MS_P_1	11:00 AM	-
	005es19277:MMN_Stn	11:00 AM	1:00 PM
	005es19277:_MNH_4	11:00 AM	-
	005es19277:_MN_P_2	11:00 AM	12:00 PM
	005es19277:_MNHP_2	11:00 AM	1:00 PM
	005es19303:_MN_Stn	11:00 AM	2:00 PM



	005es19303:_MNH_5	11:00 AM	2:00 PM
	005es19303:_MS_Stn	-	1:00 PM
	005es19352:_MN_Stn	11:00 AM	2:00 PM
	005es19352:_MNH_5	11:00 AM	2:00 PM
	005es19352:_MN_X_1	-	12:00 PM
	005es19352:MMS_Stn	-	1:00 PM
	005es19352:_MS_P_1	11:00 AM	-
26 of 31	005es19388:_MN_Stn	11:00 AM	2:00 PM
	005es19388:_MNH_4	11:00 AM	2:00 PM
	005es19388:_MN_X_1	11:00 AM	2:00 PM
	005es19388:_MS_Stn	-	1:00 PM
	005es19388:_MS_O_1	5:00 AM	1:00 PM
	005es19416:MMN_Stn	11:00 AM	2:00 PM
	005es19416:_MN_P_1	11:00 AM	-
	005es19416:_MS_Stn	-	1:00 PM
	005es19416:_MS_X_1	-	12:00 PM
	005es19417:_MN_P_1	-	12:00 PM
	005es19469:_MN_Stn	11:00 AM	2:00 PM
	005es19469:_MN_X_1	-	12:00 PM
	005es19469:MMS_Stn	-	1:00 PM
27 of 31	005es19843:_MN_Stn	11:00 AM	2:00 PM
	005es19843:_MN_O_1	11:00 AM	-
	005es19843:_MS_Stn	-	1:00 PM
	005es19900:_MN_Stn	11:00 AM	-
	005es19900:_MN_X_1	11:00 AM	2:00 PM
	005es19900:_MS_Stn	-	1:00 PM
	005es19900:_MS_O_2	-	2:00 PM
	005es19928:_MN_Stn	11:00 AM	-
	005es19928:_MS_X_1	11:00 AM	-
	005es19968:_MN_Stn	11:00 AM	-
	005es19968:_MS_Stn	-	1:00 PM
	005es20020:_MN_Stn	11:00 AM	-
	005es20020:_MS_Stn	-	1:00 PM
28 of 31	005es20066:_MN_Stn	11:00 AM	-
	005es20066:_MN_X_1	11:00 AM	-
	005es20066:_MN_X_2	11:00 AM	12:00 PM
	005es20066:MMS_Stn	-	1:00 PM
	005es20066:_MS_P_1	11:00 AM	2:00 PM
	005es20088:_MN_Stn	11:00 AM	-
	005es20088:_MS_Stn	-	1:00 PM
	005es20088:_MS_X_1	11:00 AM	-
	005es20137:_MN_Stn	11:00 AM	-
	005es20137:_MS_Stn	-	1:00 PM
	005es20182:_MN_Stn	11:00 AM	-
	005es20182:_MS_Stn	-	1:00 PM
	005es20234:_MN_Stn	11:00 AM	-

		005es20234:_MN_X_1	11:00 AM	-
		005es20234:MMS_Stn	-	1:00 PM
		005es20234:_MS_P_2	-	1:00 PM
		005es20259:_MN_Stn	11:00 AM	-
		005es20259:_MN_O_1	11:00 AM	-
		005es20259:_MS_Stn	-	1:00 PM
		005es20259:_MS_X_1	11:00 AM	-
	29 of 31	005es20313:_MN_Stn	11:00 AM	-
		005es20313:_MS_Stn	-	1:00 PM
		005es20369:_MN_Stn	11:00 AM	-
		005es20369:_MS_Stn	-	1:00 PM
		005es20424:_MN_Stn	11:00 AM	-
		005es20424:_MS_Stn	-	1:00 PM
		005es20478:_MN_Stn	11:00 AM	-
		005es20478:_MS_Stn	-	1:00 PM
		005es20533:_MN_Stn	11:00 AM	-
		005es20533:_MS_Stn	-	1:00 PM
	30 of 31	005es20587:_MN_Stn	11:00 AM	-
		005es20587:_MN_X_1	11:00 AM	2:00 PM
		005es20587:_MN_O_1	11:00 AM	-
		005es20587:MMS_Stn	-	1:00 PM
		005es20587:_MSHP_1	11:00 AM	-
		005es20587:_MS_P_1	11:00 AM	1:00 PM
		005es20667:_MN_Stn	11:00 AM	-
		005es20667:_MS_Stn	-	1:00 PM
		005es20720:_MN_Stn	11:00 AM	-
		005es20720:_MN_X_1	11:00 AM	12:00 PM
		005es20720:_MS_O_1	10:00 AM	12:00 PM
		005es20778:_MN_Stn	11:00 AM	-
		005es20778:_MS_Stn	-	1:00 PM
	31 of 31	005es20820:_MN_Stn	11:00 AM	-
		005es20820:_MS_Stn	-	1:00 PM
		005es20855:_MN_Stn	11:00 AM	-
		005es20855:_MN_X_1	11:00 AM	2:00 PM
		005es20855:_MS_O_1	-	1:00 PM
		005es20877:_MN_Stn	11:00 AM	-
		005es20933:_MN_Stn	11:00 AM	-
		005es21029:_MN_Stn	11:00 AM	-
		005es21029:_MN_X_1	11:00 AM	-
I-90	1 of 11	090es00261:_MW_O_1	5:00 AM	12:00 PM
	2 of 11	090es00341:_MEHP_2	11:00 AM	-
	4 of 11	090es00720:_ME_P_2	11:00 AM	-
	5 of 11	090es00912:_ME_O_1	11:00 AM	-
		090es00912:_MW_P_1	11:00 AM	-
		090es00961:_CE_X_1	11:00 AM	2:00 PM
		090es00996:_MW_P_2	11:00 AM	-

		090es00996:_MWHP_2	11:00 AM	-
		090es00996:_MW_X_2	-	12:00 PM
6 of 11		090es01090:_MEH_6	11:00 AM	-
		090es01143:_ME_Stn	11:00 AM	-
		090es01143:_MEH_4	11:00 AM	-
		090es01143:_CE__1	-	12:00 PM
		090es01143:_CE_O_1	11:00 AM	-
		090es01143:_MW_P_1	11:00 AM	12:00 PM
		090es01143:_CW_O_1	-	12:00 PM
		090es01143:_CW_O_2	11:00 AM	-
		090es01181:MME_Stn	11:00 AM	-
		090es01181:_MEH_4	11:00 AM	-
		090es01181:_ME_P_1	11:00 AM	-
		090es01181:_ME_P_2	11:00 AM	-
		090es01181:_CE_X_1	-	12:00 PM
7 of 11		090es01243:_ME_Stn	11:00 AM	-
		090es01243:_MEH_5	11:00 AM	-
		090es01289:_ME_Stn	11:00 AM	-
		090es01289:_MEH_5	11:00 AM	-
		090es01341:_ME_Stn	11:00 AM	-
		090es01341:_MEH_4	11:00 AM	-
		090es01397:_ME_Stn	11:00 AM	-
		090es01397:_MEH_4	11:00 AM	-
		090es01467:_ME_Stn	11:00 AM	-
		090es01467:_MEH_4	11:00 AM	-
8 of 11		090es01513:_ME_Stn	11:00 AM	-
		090es01577:_ME_Stn	11:00 AM	-
		090es01577:_MEHX_1	10:00 AM	-
		090es01577:_MW_P_1	11:00 AM	-
		090es01577:_MW_P_3	-	12:00 PM
		090es01577:_MW_X_1	11:00 AM	12:00 PM
		090es01635:_ME_Stn	11:00 AM	-
		090es01696:_ME_Stn	11:00 AM	-
		090es01748:_ME_Stn	11:00 AM	-
		090es01748:_ME_O_1	11:00 AM	-
		090es01790:_ME_Stn	11:00 AM	-
		090es01790:_ME_O_1	11:00 AM	-
9 of 11		090es01880:_ME_Stn	11:00 AM	-
		090es01941:_ME_Stn	11:00 AM	-
10 of 11		090es02481:_ME_Stn	11:00 AM	
SR 99	1 of 5	099es02316:_MS_X_2	11:00 AM	-
		099es02375:_MN_X_1	5:00 AM	1:00 PM
	2 of 5	099es02465:_MN_X_1	-	1:00 PM
		099es02465:_CN_O_1	11:00 AM	12:00 PM
		099es02465:_CN_X_1	5:00 AM	1:00 PM
		099es02465:_CS__1	11:00 AM	2:00 PM

		099es02465:_CS_X_1	-	1:00 PM
		099es02494:_CN_O_1	11:00 AM	-
		099es02494:_CN__1	11:00 AM	12:00 PM
		099es02494:_MS_Stn	11:00 AM	-
		099es02494:_CS__1	-	1:00 PM
		099es02494:_CS_O_1	11:00 AM	2:00 PM
		099es02494:_CS_X_1	11:00 AM	-
		099es02545:_MN_O_1	11:00 AM	-
		099es02585:_MS_Stn	11:00 AM	-
		099es02585:_MS_X_1	-	12:00 PM
	4 of 5	099es03271:_MN_O_1	11:00 AM	-
SR 167	1 of 6	167es01127:_MN_Stn	5:00 AM	1:00 PM
		167es01127:_MNH__3	5:00 AM	-
		167es01127:_MS_Stn	11:00 AM	1:00 PM
		167es01169:_MN_Stn	5:00 AM	1:00 PM
		167es01169:_MNH__3	5:00 AM	-
		167es01169:_MS_Stn	11:00 AM	1:00 PM
		167es01215:_MN_Stn	5:00 AM	1:00 PM
		167es01215:_MN_X_1	5:00 AM	1:00 PM
		167es01215:MMS_Stn	11:00 AM	1:00 PM
		167es01215:_MSH__3	11:00 AM	2:00 PM
		167es01215:_MS_P_1	-	1:00 PM
		167es01245:MMN_Stn	5:00 AM	1:00 PM
		167es01245:_MN_P_1	-	2:00 PM
		167es01245:_MS_Stn	11:00 AM	1:00 PM
		167es01245:_MSH__3	11:00 AM	2:00 PM
		167es01245:_MS_X_1	11:00 AM	-
		167es01287:_MN_Stn	5:00 AM	1:00 PM
		167es01287:_MS_Stn	11:00 AM	1:00 PM
		167es01287:_MSH__3	11:00 AM	2:00 PM
	2 of 6	167es01327:_MN_Stn	5:00 AM	1:00 PM
		167es01327:_MS_Stn	11:00 AM	1:00 PM
		167es01327:_MSH__3	11:00 AM	2:00 PM
		167es01375:_MN_Stn	5:00 AM	1:00 PM
		167es01375:MMS_Stn	11:00 AM	1:00 PM
		167es01375:_MSH__3	11:00 AM	2:00 PM
		167es01375:_MSHP_1	11:00 AM	2:00 PM
		167es01375:_MSHP_4	11:00 AM	8:00 PM
		167es01375:_MS_P_2	-	12:00 PM
		167es01375:_MS_P_3	11:00 AM	8:00 PM
		167es01375:_MS_X_1	11:00 AM	-
		167es01431:_MN_Stn	5:00 AM	1:00 PM
		167es01431:_MNH__3	5:00 AM	1:00 PM
		167es01431:_MN_O_2	11:00 AM	2:00 PM
		167es01431:_MS_Stn	11:00 AM	1:00 PM
		167es01431:_MSH__4	11:00 AM	2:00 PM

	167es01431:_MS_X_1	11:00 AM	2:00 PM
	167es01476:_MN_Stn	5:00 AM	2:00 PM
	167es01476:_MNH_4	5:00 AM	1:00 PM
	167es01476:_MN_O_1	5:00 AM	2:00 PM
	167es01476:_MS_Stn	11:00 AM	2:00 PM
	167es01476:_MSH_3	11:00 AM	2:00 PM
	167es01535:_MN_Stn	5:00 AM	2:00 PM
	167es01535:_MNH_3	5:00 AM	-
	167es01535:_MS_Stn	11:00 AM	2:00 PM
	167es01535:_MSH_4	11:00 AM	2:00 PM
	167es01565:_MN_Stn	5:00 AM	1:00 PM
	167es01565:_MNH_3	5:00 AM	-
	167es01565:MMS_Stn	11:00 AM	2:00 PM
	167es01565:_MSH_4	11:00 AM	2:00 PM
	167es01565:_MS_P_1	11:00 AM	-
	167es01565:_MS_P_2	11:00 AM	-
	167es01565:_MSHP_2	11:00 AM	-
	167es01586:MMN_Stn	12:00 PM	-
	167es01586:_MNH_3	12:00 PM	-
	167es01586:_MN_P_1	11:00 AM	-
	167es01586:_MNHP_1	-	2:00 PM
	167es01586:_MS_Stn	11:00 AM	2:00 PM
	167es01586:_MSH_4	11:00 AM	-
3 of 6	167es01628:_MN_Stn	5:00 AM	1:00 PM
	167es01628:_MNH_3	5:00 AM	-
	167es01628:_MS_Stn	11:00 AM	2:00 PM
	167es01628:_MSH_3	11:00 AM	-
	167es01687:_MN_Stn	5:00 AM	2:00 PM
	167es01687:_MNH_3	5:00 AM	1:00 PM
	167es01687:_MS_Stn	11:00 AM	2:00 PM
	167es01687:_MSH_3	11:00 AM	-
	167es01738:_MN_Stn	5:00 AM	2:00 PM
	167es01738:_MNH_3	5:00 AM	1:00 PM
	167es01738:_MS_Stn	11:00 AM	1:00 PM
	167es01738:_MSH_3	11:00 AM	-
	167es01784:MMS_Stn	11:00 AM	1:00 PM
	167es01784:_MSH_3	11:00 AM	-
	167es01784:_MS_P_1	-	1:00 PM
	167es01799:MMN_Stn	5:00 AM	1:00 PM
	167es01799:_MNH_3	5:00 AM	1:00 PM
	167es01799:_MNHP_1	-	1:00 PM
	167es01799:_MN_P_1	11:00 AM	-
	167es01849:_MN_Stn	5:00 AM	1:00 PM
	167es01849:_MNH_3	-	1:00 PM
	167es01849:_MS_Stn	11:00 AM	1:00 PM
	167es01849:_MSH_3	11:00 AM	-

4 of 6	167es01901:_MN_Stn	5:00 AM	1:00 PM
	167es01901:_MNH_3	5:00 AM	1:00 PM
	167es01901:_MS_Stn	11:00 AM	1:00 PM
	167es01901:_MSH_3	11:00 AM	-
	167es01948:MMS_Stn	11:00 AM	1:00 PM
	167es01948:_MSH_3	11:00 AM	-
	167es01948:_MS_P_1	-	7:00 PM
	167es01948:_MS_P_2	11:00 AM	12:00 PM
	167es01948:_MS_X_1	11:00 AM	-
	167es01974:MMN_Stn	5:00 AM	1:00 PM
	167es01974:_MNH_3	5:00 AM	1:00 PM
	167es01974:_MNHP_1	-	12:00 PM
	167es02019:_MN_Stn	5:00 AM	1:00 PM
	167es02019:_MNH_3	5:00 AM	1:00 PM
	167es02019:_MS_Stn	11:00 AM	1:00 PM
	167es02019:_MSH_3	11:00 AM	-
	167es02139:MMN_Stn	5:00 AM	2:00 PM
	167es02139:_MNH_3	5:00 AM	1:00 PM
	167es02139:_MNHP_1	-	1:00 PM
	167es02139:_MN_P_1	11:00 AM	-
167es02139:_MS_X_1	11:00 AM	-	
5 of 6	167es02189:_MN_Stn	5:00 AM	1:00 PM
	167es02189:_MNH_3	5:00 AM	1:00 PM
	167es02189:_MS_Stn	11:00 AM	1:00 PM
	167es02189:_MSH_3	11:00 AM	-
	167es02226:MMS_Stn	11:00 AM	2:00 PM
	167es02226:_MSH_3	11:00 AM	-
	167es02226:_MSHP_1	11:00 AM	-
	167es02234:MMN_Stn	5:00 AM	1:00 PM
	167es02234:_MNH_3	5:00 AM	1:00 PM
	167es02234:_MN_P_1	11:00 AM	-
	167es02293:_MN_Stn	5:00 AM	1:00 PM
	167es02293:_MNH_3	5:00 AM	1:00 PM
	167es02293:_MS_Stn	11:00 AM	1:00 PM
	167es02293:_MSH_3	11:00 AM	-
	167es02342:_MN_Stn	5:00 AM	1:00 PM
	167es02342:_MNH_3	5:00 AM	1:00 PM
	167es02342:_MS_Stn	11:00 AM	1:00 PM
	167es02342:_MSH_3	11:00 AM	-
	167es02390:_MN_Stn	5:00 AM	1:00 PM
	167es02390:_MNH_3	5:00 AM	1:00 PM
167es02390:_MS_Stn	11:00 AM	1:00 PM	
167es02390:_MSH_3	11:00 AM	-	
6 of 6	167es02445:MMS_Stn	-	1:00 PM
	167es02445:_MSH_3	11:00 AM	-
	167es02445:_MSHP_1	11:00 AM	2:00 PM

		167es02445:_MS_P_1	11:00 AM	12:00 PM
		167es02445:_MS_X_1	11:00 AM	-
		167es02461:MMN_Stn	5:00 AM	1:00 PM
		167es02461:_MNH_3	5:00 AM	1:00 PM
		167es02461:_MN_P_1	11:00 AM	-
		167es02507:_MN_Stn	5:00 AM	1:00 PM
		167es02507:_MS_Stn	-	2:00 PM
		167es02507:_MSH_4	11:00 AM	-
		167es02562:_MN_Stn	5:00 AM	1:00 PM
		167es02562:_MS_Stn	-	2:00 PM
		167es02562:_MSH_4	11:00 AM	-
		167es02614:_MN_Stn	-	1:00 PM
		167es02614:_MNHX_1	5:00 AM	-
		167es02614:_MN_X_2	5:00 AM	2:00 PM
		167es02614:_MS_Stn	11:00 AM	2:00 PM
		167es02614:_MSHO_2	11:00 AM	-
		167es02614:_MS_O_1	11:00 AM	-
I-405	1 of 16	405es00011:_MN__1	-	1:00 PM
		405es00011:_MNH_O_1	11:00 AM	-
		405es00011:_MN_O_1	11:00 AM	2:00 PM
		405es00011:_MN_O_2	5:00 AM	-
		405es00011:_MS_Stn	-	2:00 PM
		405es00011:_MS_X_1	11:00 AM	-
		405es00011:_MS_X_2	5:00 AM	1:00 PM
		405es00044:_MN_Stn	-	2:00 PM
		405es00044:_MNH_4	11:00 AM	-
		405es00044:_MN_O_1	11:00 AM	-
		405es00044:_MS_Stn	-	1:00 PM
		405es00086:MMS_Stn	-	1:00 PM
		405es00086:_MS_P_1	11:00 AM	-
		405es00086:_MS_P_2	11:00 AM	-
		405es00086:_MS_X_1	11:00 AM	-
		405es00092:MMN_Stn	11:00 AM	-
		405es00092:_MNH_4	11:00 AM	-
		405es00092:_MN_P_1	11:00 AM	-
		405es00092:_MN_P_2	11:00 AM	-
		405es00092:_MN_X_1	-	2:00 PM
		405es00139:_MN_Stn	11:00 AM	-
		405es00139:_MNH_4	11:00 AM	-
		405es00139:_MS_Stn	-	1:00 PM
	2 of 16	405es00171:_MN_Stn	11:00 AM	-
		405es00171:_MNH_4	11:00 AM	-
		405es00171:_MS_Stn	-	1:00 PM
		405es00221:_MN_Stn	11:00 AM	-
		405es00221:_MNH_3	10:00 AM	-
		405es00221:_CN_O_1	11:00 AM	-

	405es00221:_CN_X_1	11:00 AM	-
	405es00221:MMS_Stn	-	1:00 PM
	405es00221:_MS_P_1	-	1:00 PM
	405es00221:_MS_P_2	-	1:00 PM
	405es00221:_MS_O_1	5:00 AM	1:00 PM
	405es00221:_MS_X_1	-	12:00 PM
	405es00221:_MS_X_2	-	2:00 PM
	405es00268:MMN_Stn	11:00 AM	-
	405es00268:_MNHO_2	5:00 AM	-
	405es00268:_MN_O_1	11:00 AM	-
	405es00268:_MN_P_2	5:00 AM	1:00 PM
	405es00268:_MS_Stn	-	1:00 PM
	405es00268:_MSH_3	-	2:00 PM
	405es00268:_MSHX_2	11:00 AM	-
	405es00294:MMN_Stn	5:00 AM	-
	405es00294:_MNH_4	5:00 AM	-
	405es00294:_MN_P_1	5:00 AM	1:00 PM
	405es00294:_MN_P_2	5:00 AM	-
	405es00294:_MS_Stn	-	1:00 PM
	405es00342:_MN_Stn	11:00 AM	-
	405es00342:_MS_Stn	-	2:00 PM
3 of 16	405es00391:_MN_Stn	5:00 AM	-
	405es00391:_MN_X_1	11:00 AM	-
	405es00391:MMS_Stn	-	2:00 PM
	405es00391:_MSH_3	11:00 AM	-
	405es00391:_MS_P_1	-	2:00 PM
	405es00391:_MS_P_2	-	1:00 PM
	405es00412:MMN_Stn	5:00 AM	-
	405es00412:_MN_P_1	5:00 AM	12:00 PM
	405es00473:MMN_Stn	5:00 AM	-
	405es00473:_MN_P_1	-	2:00 PM
	405es00473:_MS_Stn	2:00 PM	-
	405es00473:_MSH_3	11:00 AM	-
	405es00473:_MS_X_1	11:00 AM	-
	405es00532:MMS_Stn	-	12:00 PM
	405es00532:_MSH_3	11:00 AM	-
	405es00532:_MSHP_1	-	2:00 PM
	405es00532:_MS_X_1	-	1:00 PM
	405es00532:_MS_X_2	11:00 AM	7:00 PM
	405es00532:_MS_P_1	1:00 PM	-
	405es00536:MMN_Stn	5:00 AM	2:00 PM
	405es00536:_MNHP_1	-	2:00 PM
	405es00536:_MN_P_1	-	2:00 PM
	405es00536:_MN_X_1	11:00 AM	-
	405es00608:_MN_Stn	5:00 AM	2:00 PM
	405es00608:_MS_Stn	-	12:00 PM



	405es00608:_MSH_3	11:00 AM	2:00 PM
4 of 16	405es00646:MMS_Stn	-	12:00 PM
	405es00646:_MSH_3	11:00 AM	-
	405es00646:_MS_X_1	11:00 AM	-
	405es00656:MMN_Stn	5:00 AM	2:00 PM
	405es00656:_MNHP_1	-	2:00 PM
	405es00656:_MN_P_1	-	2:00 PM
	405es00656:_MN_X_1	11:00 AM	-
	405es00700:_MN_Stn	5:00 AM	-
	405es00700:_MS_Stn	-	12:00 PM
	405es00700:_MSH_3	11:00 AM	2:00 PM
	405es00740:MMS_Stn	-	12:00 PM
	405es00740:_MSH_3	11:00 AM	2:00 PM
	405es00740:_MS_X_1	11:00 AM	-
	405es00745:MMN_Stn	5:00 AM	2:00 PM
	405es00745:_MN_O_1	-	12:00 PM
	405es00745:_MN_P_1	-	2:00 PM
	405es00745:_MN_P_2	-	12:00 PM
	405es00745:_MN_X_1	11:00 AM	-
	405es00803:_MN_Stn	-	2:00 PM
	405es00803:_MS_Stn	11:00 AM	12:00 PM
	405es00803:_MSH_3	11:00 AM	2:00 PM
	405es00840:_MN_Stn	-	2:00 PM
	405es00840:_MS_Stn	11:00 AM	12:00 PM
	405es00840:_MSH_3	11:00 AM	2:00 PM
5 of 16	405es00890:_MN_Stn	-	2:00 PM
	405es00890:_MS_Stn	-	12:00 PM
	405es00890:_MSH_3	11:00 AM	2:00 PM
	405es00921:MMS_Stn	11:00 AM	12:00 PM
	405es00921:_MSH_3	11:00 AM	2:00 PM
	405es00921:_MN_X_1	11:00 AM	-
	405es00921:_MS_P_2	-	12:00 PM
	405es00936:MMN_Stn	-	2:00 PM
	405es00936:_MN_P_3	-	12:00 PM
	405es00936:_MS_X_1	11:00 AM	7:00 PM
	405es00975:_MS_Stn	11:00 AM	12:00 PM
	405es00975:_MSH_3	11:00 AM	2:00 PM
	405es01013:_MN_X_1	11:00 AM	-
	405es01013:MMS_Stn	11:00 AM	12:00 PM
	405es01013:_MSH_3	11:00 AM	2:00 PM
	405es01013:_MS_P_1	11:00 AM	-
	405es01013:_MS_P_2	11:00 AM	-
	405es01031:_MS_X_1	-	12:00 PM
	405es01031:_MS_X_2	11:00 AM	-
	405es01031:_MS_X_3	11:00 AM	7:00 PM
6 of 16	405es01079:_MN_Stn	-	2:00 PM

	405es01079:_MS_Stn	11:00 AM	12:00 PM
	405es01079:_MSH__3	11:00 AM	2:00 PM
	405es01079:_MS_O_1	11:00 AM	-
	405es01079:_MS_O_2	-	12:00 PM
	405es01128:_MN_Stn	-	2:00 PM
	405es01128:_MS_Stn	11:00 AM	12:00 PM
	405es01128:_MSH__3	11:00 AM	2:00 PM
	405es01178:_MN_Stn	-	2:00 PM
	405es01178:_MS_Stn	11:00 AM	12:00 PM
	405es01178:_MSH__6	11:00 AM	2:00 PM
	405es01228:_MN_Stn	-	2:00 PM
	405es01229:_MS_Stn	11:00 AM	12:00 PM
	405es01229:_MSH__6	11:00 AM	2:00 PM
7 of 16	405es01272:MMS_Stn	-	1:00 PM
	405es01272:_MSH__5	-	2:00 PM
	405es01272:_MSHP_1	11:00 AM	-
	405es01272:_MS_P_1	11:00 AM	-
	405es01272:_MS_P_2	11:00 AM	-
	405es01290:MMN_Stn	-	2:00 PM
	405es01290:_MN_X_2	-	12:00 PM
	405es01331:_MN_Stn	-	2:00 PM
8 of 16	405es01333:MMS_Stn	-	1:00 PM
	405es01333:_MSH__4	-	2:00 PM
	405es01333:_MS_P_1	11:00 AM	2:00 PM
	405es01333:_MS_P_2	11:00 AM	2:00 PM
	405es01333:_MS_P_3	11:00 AM	12:00 PM
	405es01333:_MSHP_4	11:00 AM	2:00 PM
	405es01333:_MS_X_1	-	12:00 PM
	405es01333:_CS_O_1	11:00 AM	2:00 PM
	405es01333:_CS_X_1	-	12:00 PM
	405es01333:_CS_X_3	-	12:00 PM
	405es01333:_MSRA_1	11:00 AM	2:00 PM
	405es01333:_MSRA_2	11:00 AM	2:00 PM
	405es01360:MMN_Stn	-	2:00 PM
	405es01360:_MN_P_1	11:00 AM	-
	405es01360:_MN_X_1	-	12:00 PM
	405es01360:_MN_X_2	-	12:00 PM
	405es01360:_MSHO_1	11:00 AM	-
	405es01392:_MNH__6	11:00 AM	-
	405es01392:_MNHO_1	11:00 AM	-
	405es01392:_CN_O_1	11:00 AM	-
	405es01392:_CN_O_2	11:00 AM	-
	405es01392:_CN_X_1	-	12:00 PM
	405es01392:_CN__1	-	12:00 PM
	405es01392:DCN__1	11:00 AM	-
	405es01392:_MS_Stn	-	2:00 PM

	405es01392:_MSH__4	-	2:00 PM
9 of 16	405es01360:_MN_X_1	-	12:00 PM
	405es01360:_MN_X_2	-	12:00 PM
	405es01427:_MN_Stn	11:00 AM	2:00 PM
	405es01427:_MS_Stn	-	1:00 PM
	405es01427:_MSH__5	-	2:00 PM
	405es01463:MMN_Stn	11:00 AM	2:00 PM
	405es01463:_MN_P_1	11:00 AM	-
	405es01463:_MN_P_2	11:00 AM	2:00 PM
	405es01463:_MNH_P_2	11:00 AM	-
	405es01463:_MN_M_1	11:00 AM	-
	405es01465:_MS_Stn	-	1:00 PM
	405es01508:_MN_Stn	11:00 AM	2:00 PM
	405es01508:_MN_O_1	11:00 AM	2:00 PM
	405es01508:_MS_Stn	-	1:00 PM
	405es01563:_MN_Stn	11:00 AM	2:00 PM
	405es01563:_MNHStn	11:00 AM	-
	405es01563:_MS_Stn	-	12:00 PM
	405es01612:_MN_Stn	11:00 AM	2:00 PM
	405es01612:_MNHStn	11:00 AM	-
	405es01612:_MS_Stn	-	12:00 PM
10 of 16	405es01667:_MN_Stn	11:00 AM	2:00 PM
	405es01667:_MNHStn	11:00 AM	-
	405es01667:_MS_Stn	-	12:00 PM
	405es01723:_MN_Stn	11:00 AM	12:00 PM
	405es01723:_MNHStn	11:00 AM	-
	405es01723:_MNBX_3	4:00 AM	-
	405es01723:MMS_Stn	12:00 PM	-
	405es01723:_MS_P_1	11:00 AM	2:00 PM
	405es01723:_CSB__1	5:00 AM	1:00 PM
	405es01749:MMN_Stn	11:00 AM	2:00 PM
	405es01749:_MNHStn	11:00 AM	-
	405es01749:_MN_P_2	11:00 AM	-
405es01749:_MS_Stn	12:00 PM	-	
11 of 16	405es01799:_MN_Stn	11:00 AM	2:00 PM
	405es01799:_MNHStn	11:00 AM	-
	405es01799:_CN_X_1	11:00 AM	12:00 PM
	405es01799:MMS_Stn	-	12:00 PM
	405es01799:_CS_P_1	11:00 AM	2:00 PM
	405es01799:_CS_P_2	11:00 AM	-
	405es01799:_CS__1	11:00 AM	2:00 PM
	405es01823:MMN_Stn	11:00 AM	2:00 PM
	405es01823:_MNHStn	11:00 AM	-
	405es01823:_CNHP_2	11:00 AM	-
	405es01823:_CN_P_1	11:00 AM	2:00 PM
405es01823:_CN_P_2	11:00 AM	7:00 PM	

	405es01823:_CN_X_1	-	12:00 PM
	405es01823:_MS_Stn	-	12:00 PM
	405es01870:_MN_Stn	11:00 AM	2:00 PM
	405es01870:_MNHStn	11:00 AM	-
	405es01870:_MS_Stn	-	12:00 PM
	405es01921:_MN_Stn	11:00 AM	2:00 PM
	405es01921:_MNHStn	11:00 AM	-
	405es01921:_MS_Stn	-	12:00 PM
12 of 16	405es01971:_MN_Stn	11:00 AM	2:00 PM
	405es01971:_MNHStn	11:00 AM	-
	405es01971:_MN_X_1	-	1:00 PM
	405es01972:MMS_Stn	-	12:00 PM
	405es01972:_MSHP_2	-	12:00 PM
	405es01972:_MS_P_1	11:00 AM	-
	405es01972:_MS_P_2	11:00 AM	-
	405es02022:_MN_Stn	11:00 AM	2:00 PM
	405es02022:_MNHStn	11:00 AM	2:00 PM
	405es02022:MMS_Stn	-	12:00 PM
	405es02022:_MSHP_2	-	12:00 PM
	405es02022:_MS_P_1	11:00 AM	-
	405es02022:_MS_P_2	-	12:00 PM
	405es02022:_MS_P_3	11:00 AM	-
	405es02047:MMN_Stn	11:00 AM	2:00 PM
	405es02047:_MNHStn	11:00 AM	-
	405es02047:_MNHX_3	11:00 AM	-
	405es02047:_MN_P_1	11:00 AM	-
	405es02047:_MN_P_2	11:00 AM	2:00 PM
	405es02047:_MN_P_3	11:00 AM	1:00 PM
	405es02047:_MN_X_1	-	1:00 PM
	405es02047:_MN_X_2	11:00 AM	-
	405es02047:_MS_Stn	-	12:00 PM
13 of 16	405es02093:_MN_Stn	11:00 AM	2:00 PM
	405es02093:_MNHStn	11:00 AM	-
	405es02093:_MS_Stn	-	12:00 PM
	405es02093:_MSHX_1	-	1:00 PM
	405es02136:_MN_Stn	11:00 AM	2:00 PM
	405es02136:_MNHStn	11:00 AM	-
	405es02136:_MS_Stn	-	12:00 PM
	405es02183:_MN_Stn	11:00 AM	-
	405es02183:_MNH__5	11:00 AM	-
	405es02183:_MS_Stn	-	12:00 PM
	405es02183:_MSHStn	-	2:00 PM
	405es02231:_MN_Stn	11:00 AM	-
	405es02231:_MNH__5	11:00 AM	-
	405es02231:MMS_Stn	-	12:00 PM
	405es02231:_MS_P_1	-	12:00 PM

	405es02273:_MN_X_1	11:00 AM	2:00 PM
	405es02273:_MN_X_2	11:00 AM	-
	405es02273:_MS_Stn	-	2:00 PM
	405es02273:_MSH_4	-	2:00 PM
	405es02273:_MS_X_2	11:00 AM	-
	405es02301:MMN_Stn	11:00 AM	-
	405es02301:_MNH_3	11:00 AM	-
	405es02301:_MN_X_1	11:00 AM	-
14 of 16	405es02301:_MSB_1	-	10:00 PM
	405es02351:_MN_Stn	11:00 AM	-
	405es02351:_MNH_3	11:00 AM	-
	405es02351:_CN_X_1	11:00 AM	-
	405es02351:MMS_O_2	-	12:00 PM
	405es02369:MMN_Stn	11:00 AM	-
	405es02369:_MNH_3	11:00 AM	-
	405es02369:_MS_X_1	11:00 AM	-
	405es02393:_MN_Stn	11:00 AM	-
	405es02393:_MNH_3	11:00 AM	-
	405es02393:_CN_O_1	11:00 AM	-
	405es02393:_MS_X_2	11:00 AM	-
	405es02439:_MN_Stn	11:00 AM	-
	405es02439:_MNH_3	11:00 AM	-
	405es02439:MMS_Stn	-	2:00 PM
	405es02465:MMN_Stn	11:00 AM	-
	405es02465:_MNH_3	11:00 AM	-
	405es02465:_MNHP_1	11:00 AM	-
	405es02465:_MN_P_1	11:00 AM	-
	405es02465:_MS_Stn	-	2:00 PM
	405es02465:_MS_X_1	10:00 AM	-
	405es02468:_MN_P_1	11:00 AM	2:00 PM
15 of 16	405es02517:_MN_Stn	11:00 AM	-
	405es02517:_MNH_4	11:00 AM	-
	405es02517:_MS_Stn	-	2:00 PM
	405es02517:_MSH_3	-	2:00 PM
	405es02556:_MS_Stn	-	2:00 PM
	405es02556:_MSH_3	-	2:00 PM
	405es02568:_MN_Stn	11:00 AM	-
	405es02568:_MNH_4	11:00 AM	-
	405es02616:_MN_Stn	11:00 AM	-
	405es02616:_MNH_4	11:00 AM	-
	405es02616:_MS_Stn	-	2:00 PM
	405es02616:_MSH_3	-	2:00 PM
	405es02662:_MN_Stn	11:00 AM	-
	405es02662:_MNH_3	11:00 AM	-
	405es02662:MMS_Stn	-	2:00 PM
	405es02662:_MSH_3	-	2:00 PM

		405es02662:_MS_P_1	11:00 AM	-
		405es02662:_MSHP_1	-	2:00 PM
		405es02663:_MS_P_2	11:00 AM	-
		405es02687:_MNHP_1	11:00 AM	-
		405es02687:_MN_P_1	11:00 AM	-
		405es02688:MMN_Stn	11:00 AM	-
		405es02688:_MNH__3	11:00 AM	-
		405es02688:_MNHP_1	11:00 AM	-
		405es02688:_MS_Stn	-	2:00 PM
		405es02688:_MSH__3	-	2:00 PM
		405es02744:_MN_Stn	11:00 AM	1:00 PM
		405es02744:_MNH__3	11:00 AM	-
		405es02744:_MSH__3	-	2:00 PM
	16 of 16	405es02796:_MN_Stn	11:00 AM	1:00 PM
		405es02796:_MNH__3	11:00 AM	-
		405es02796:_MSH__3	-	2:00 PM
		405es02853:_MN_Stn	11:00 AM	1:00 PM
		405es02853:_MNH__3	11:00 AM	-
		405es02853:_MS_Stn	-	2:00 PM
		405es02853:_MSH__3	-	2:00 PM
		405es02898:_MN_Stn	11:00 AM	1:00 PM
		405es02898:_MNH__3	11:00 AM	-
		405es02898:_MS_Stn	-	2:00 PM
		405es02898:_MSH__4	-	2:00 PM
		405es02953:_MN_Stn	11:00 AM	2:00 PM
		405es02953:_MNH__4	11:00 AM	-
		405es02953:_MS_Stn	-	2:00 PM
		405es02953:_MSH__5	-	2:00 PM
		405es03006:_MN_Stn	11:00 AM	-
SR 509	3 of 4	509es02902:_MS_Stn	11:00 AM	-
		509es02947:_MS_Stn	11:00 AM	-
		509es02947:_MS_O_1	11:00 AM	-
		509es02947:_MS_X_1	11:00 AM	-
	4 of 4	509es02976:_MN_X_1	11:00 AM	-
		509es02976:_MN_O_1	11:00 AM	-
		509es02976:_MS_Stn	11:00 AM	-
		509es02976:_MSH__3	11:00 AM	-
		509es02976:_MS_X_1	11:00 AM	-
SR 518	2 of 3	518es00228:MME_Stn	11:00 AM	8:00 PM
		518es00228:_ME_P_2	11:00 AM	12:00 PM
		518es00228:_ME_X_2	-	10:00 PM
		518es00247:_ME_O_2	11:00 AM	9:00 PM
		518es00247:_ME_O_3	11:00 AM	8:00 PM
		518es00247:_MW_X_1	11:00 AM	-
		518es00247:_MW_X_2	11:00 AM	1:00 PM
		518es00247:_MW_X_3	5:00 AM	8:00 PM

		518es00247:_MW_X_4	-	1:00 PM
		518es00267:MME_Stn	11:00 AM	1:00 PM
		518es00267:_ME_P_2	-	12:00 PM
	3 of 3	518es00300:_ME_Stn	11:00 AM	1:00 PM
		518es00341:_ME_Stn	11:00 AM	1:00 PM
		518es00341:_ME_X_1	11:00 AM	-
		518es00341:_MW_O_1	11:00 AM	-
SR 520	1 of 6	520es00104:_MW_O_1	11:00 AM	-
	2 of 6	520es00448:_ME_X_1	11:00 AM	-
	4 of 6	520es00684:_MW_X_2	-	7:00 PM
		520es00746:_MW_P_1	11:00 AM	-
		520es00746:_MW_P_1	-	12:00 PM
	5 of 6	520es00911:_MWH_P_4	-	2:00 PM
520es00911:_MWH_1		-	2:00 PM	
520es00911:MMW_Stn		-	2:00 PM	
520es01001:_CW_P_2		11:00 AM	-	
520es01031:_CE_P_2		11:00 AM	-	
6 of 6	520es01299:_ME_O_1	11:00 AM	-	
	520es01265:_MW_P_1	-	2:00 PM	
SR 522	3 of 5	522es01326:_MW_Stn	-	12:00 PM
		522es01400:_MW_Stn	-	12:00 PM
		522es01400:_MW_X_1	-	12:00 PM
		522es01400:_ME_O_1	11:00 AM	-
		522es01400:_ME_Stn	11:00 AM	-
		522es01400:_ME_X_1	11:00 AM	-
		522es01326:_ME_Stn	11:00 AM	-
	4 of 5	522es01840:UMW_Stn	-	12:00 PM
		522es01840:_MW_P_1	-	12:00 PM
		522es01840:UME_Stn	11:00 AM	-
		522es01895:_ME_X_1	11:00 AM	-
		522es01895:_ME_P_1	3:00 AM	-
	5 of 5	522es02030:UMW_Stn	-	2:00 PM
		522es02086:_MW_Stn	-	2:00 PM
		522es02135:_MW_Stn	-	2:00 PM
		522es02187:_MW_Stn	-	2:00 PM
		522es02237:_MW_Stn	-	2:00 PM
		522es02289:_MW_Stn	-	2:00 PM
		522es02289:_MW_O_1	-	2:00 PM
		522es02333:_MW_Stn	-	12:00 PM
		522es02381:_MW_Stn	-	12:00 PM
522es02432:_MW_Stn		-	12:00 PM	
522es02474:_MW__1		-	12:00 PM	
522es02432:_ME_X_1		11:00 AM	-	
522es02432:_ME_Stn		11:00 AM	-	
522es02381:_ME_Stn		11:00 AM	-	
522es02333:_ME_O_1	-	2:00 PM		

		522es02333:_ME_Stn	11:00 AM	-
		522es02289:_ME_Stn	11:00 AM	-
		522es02237:_ME_Stn	11:00 AM	-
		522es02187:_ME_Stn	11:00 AM	-
		522es02135:_ME_Stn	11:00 AM	-
		522es02086:_ME_Stn	11:00 AM	-
		522es02030:UME_Stn	11:00 AM	-
SR 525	1 of 2	525es00056:_MS_O_1	11:00 AM	-
		525es00096:_MN_O_1	11:00 AM	-
		525es00096:_MN_X_1	11:00 AM	-
	2 of 2	525es00252:_MN_O_1	11:00 AM	-
		525es00252:_MN_X_1	11:00 AM	-
SR 526	2 of 2	526es00357:_ME_Stn	11:00 AM	2:00 PM
		526es00357:_MW_Stn	5:00 AM	1:00 PM
SR 599	1 of 2	599es00045:_MS_O_1	11:00 AM	2:00 PM
		599es00045:_MS_Stn	11:00 AM	2:00 PM
	2 of 2	599es00045:_MS_Stn	11:00 AM	2:00 PM
		599es00169:_MN_X_1	-	1:00 PM
		599es00169:_MS_O_1	11:00 AM	2:00 PM
		599es00169:_MS_Stn	11:00 AM	2:00 PM