

2023 Ramp & Roadway

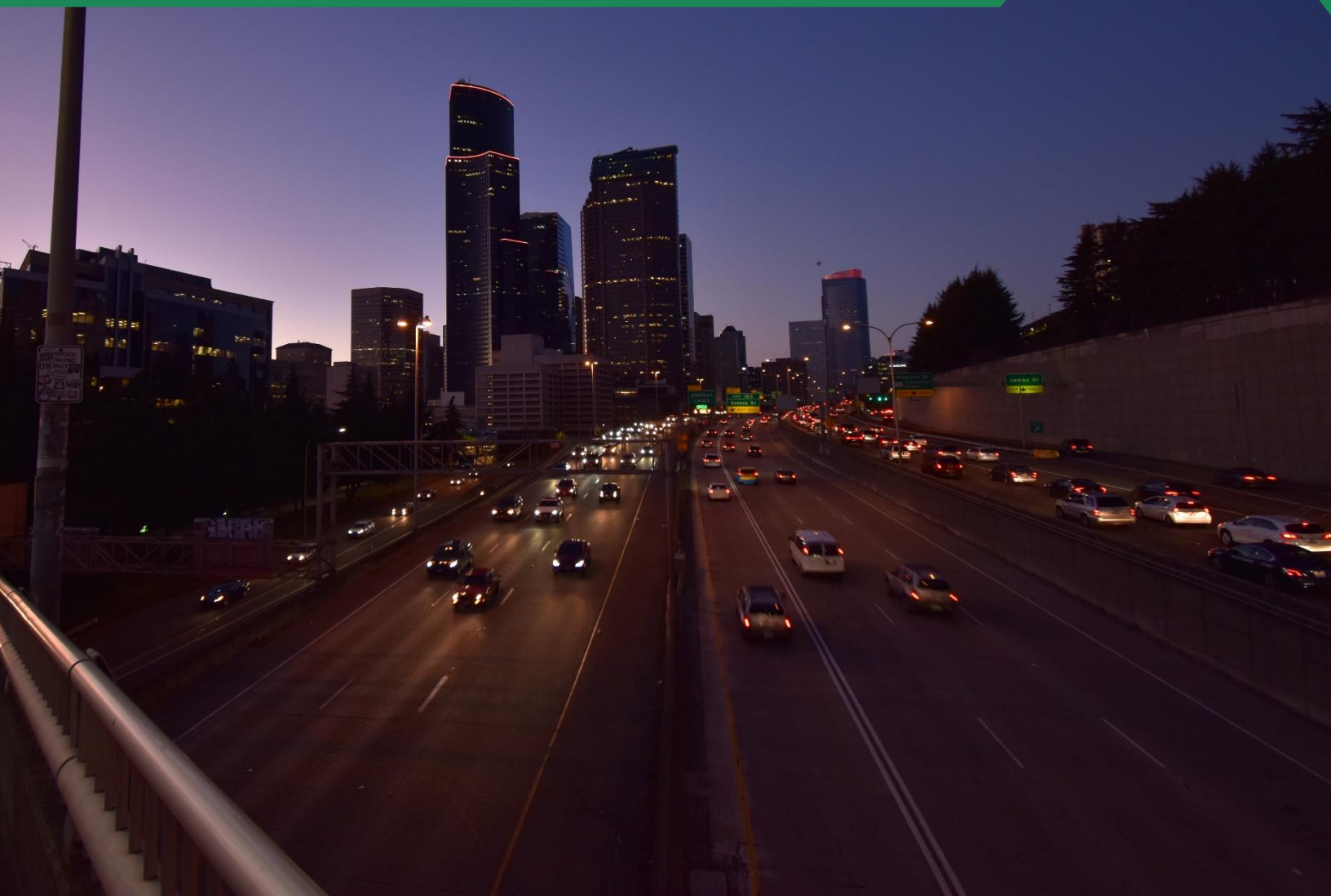

Washington State Department of
Transportation

Northwest Region
Average Daily Volumes

Page Intentionally Left Blank

Table of Contents

Summary Report.....3
Legend.....5
I-56
I-9037
I-40548
SR 1864
SR 9971
SR 16776
SR 50982
SR 51886
SR 52089
SR 52295
SR 525100
SR 526102
SR 599104
US 2.....106
Appendix108

RAMP AND ROADWAY TRAFFIC VOLUME REPORT

2023 SUMMARY REPORT

During 2024, the Transportation Management Center (TMC) of the Northwest Region updated the 2023 Ramp and Roadway Volumes Report. Traffic counts were taken from January 2023 through December 2023 from vehicle detection loops.

The following interstate and state highways are included in this report:

- 1) I-5 from the Pierce County Line to the Stillaguamish River
- 2) I-90 from 4th Ave S in Seattle to High Point Way
- 3) I-405 from I-5 in Tukwila to I-5 in Lynnwood
- 4) SR-18 from I-5 to Issaquah-Hobart Road
- 5) SR-99 from SR-599 Pacific Hwy S to Raye St Seattle
- 6) SR-167 from the Pierce County Line to I-405
- 7) SR-509 from S 188th St to 1st Ave Bridge S
- 8) SR-518 from SR-509 to I-5
- 9) SR-520 from I-5 to SR-202 Redmond Way
- 10) SR-522 from 65th Ave NE to US-2
- 11) SR-525 from Alderwood Mall Blvd to SR-99 Pacific Hwy
- 12) SR-526 from Airport Rd to I-5
- 13) SR-599 from I-5 to SR-99 Pacific Hwy
- 14) US 2 from I-5 to Rice Rd

Average weekday volumes (AWD) were computed from Tuesday through Thursday data. AM and PM peaks correspond to the highest hourly volumes. If a peak occurred outside of 6:00 AM to 10:00 AM or 2:00 PM to 7:00 PM, it is indicated in the report with an asterisk (*). The peak times for those locations are noted in the appendix.

NOTE: All roadway drawings are NOT drawn to scale.

2023 SUMMARY REPORT

Special thanks go to the Northwest Region Transportation Management Center engineers, technicians, and interns for their hard work in compiling and analyzing the data for this report.

An electronic copy of the ramp and roadway data sheets contained in this report is also posted on our website at the following address:

<https://wsdot.wa.gov/about/transportation-data/travel-data/ramp-roadway-report>

For more information on this report, please contact:

Northwest Region Transportation Management Center
15710 Dayton Avenue North
P.O. Box 330310
Seattle, WA 98133-9710

Email: nwflow@wsdot.wa.gov
Fax: (206) 440-4804

LEGEND

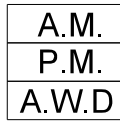

RAMP VOLUME

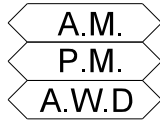

HIGH-OCCUPANCY VEHICLE (HOV) LANE VOLUME

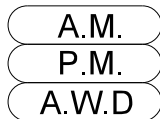

MAINLINE VOLUME
(DOES NOT INCLUDE HOV LANE VOLUME)

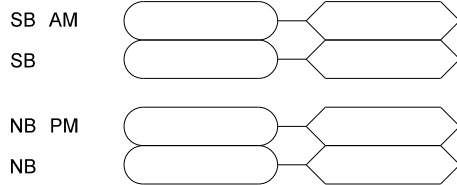

I-5 REVERSIBLE LANES VOLUME

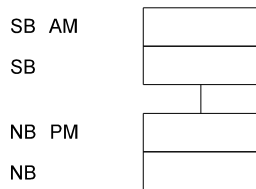

I-5 REVERSIBLE RAMP VOLUME



HOV FACILITY



BEGINNING OR END OF HOV FACILITY



METERED RAMP SHOULDER

*

PEAK HOUR OCCURRED OUTSIDE OF NORMAL PEAK HOUR
(6:00 A.M. TO 10:00 A.M. OR 2:00 P.M. TO 7:00 P.M.; SEE APPENDIX)

S

SPEED DATA AVAILABLE AT THIS LOCATION

T

SPEED DATA OBTAINED FROM TUBE COUNTERS

A.M.

A.M. PEAK HOUR VOLUME

P.M.

P.M. PEAK HOUR VOLUME

A.W.D

AVERAGE WEEKDAY VOLUME

CONSTR

DATA NOT AVAILABLE DUE TO CONSTRUCTION

N.A.

DATA NOT AVAILABLE



Pierce County Line

S 375TH ST

Federal Way Weigh Station

Enchanted PKWY

S

5200*	840*
5940	1360
89250	14040

S

5240*	820*
5970	1340
89580	13690

S

4930*	790*
5810	1320
89970	13270

S

5490*	700*
6270	1180
91620	11860

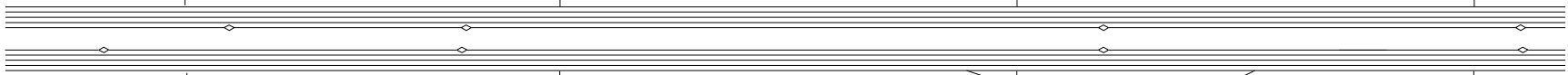

WEIGH STATION
REST AREA

NA
NA
NA

80*
80*
1010

S

4950*	860*
5200*	1020
85300	14150

S

5240*	870*
5430*	1030
85500	14240

S

4950*	860*
5160*	1040
85650	14120

S

5270*	850*
5430*	1070
91160	14070

	Washington State Department of Transportation		1 OF 31
--	--------------------------------------------------	--	---------------

EXIT 142A\B

SR 18

EXIT 143

S 320TH ST



S 317TH ST
PARK & RIDE
DIRECT ACCESS

S 308TH ST

S 336TH ST S 329TH ST

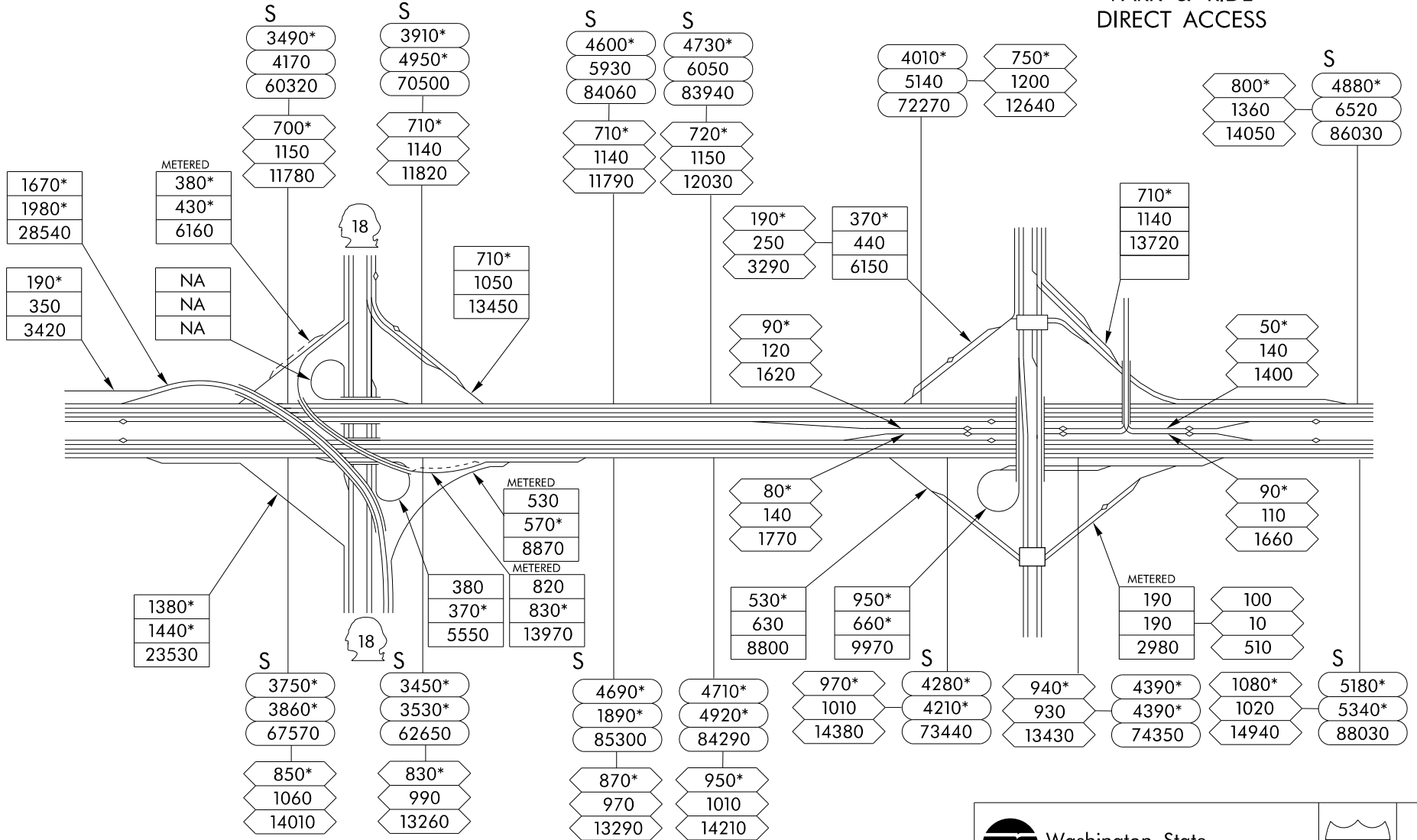

	Washington State Department of Transportation		2 OF 31
--	--------------------------------------------------	--	---------------

S 298TH ST

S 289TH ST

S 280TH ST

EXIT 147

S 272ND ST

S 266TH ST

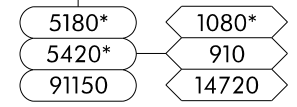
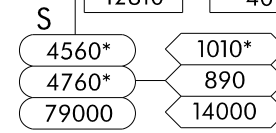
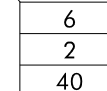
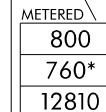
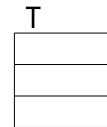
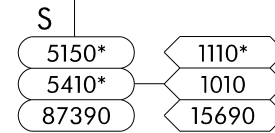
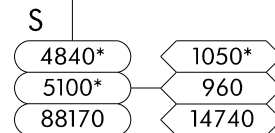
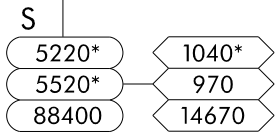
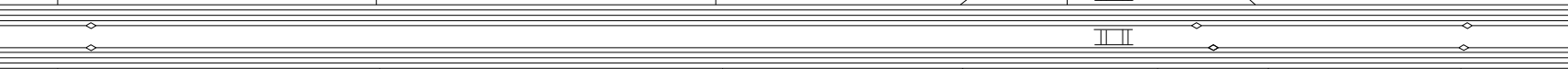
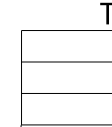
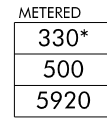
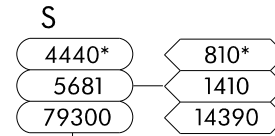
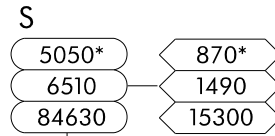
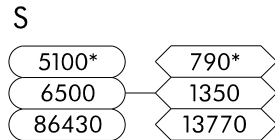
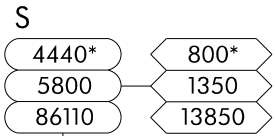

Washington State Department of Transportation



3 OF 31

S 260TH ST

S 252ND ST

S 243RD ST

EXIT 149A/B

SR 516

S 216TH ST



S

4850*	790*
6320	1420
98010	14030

4850*	790*
6310	1440
98360	14170

S

5310*	920*
6810	1610
96680	16340

4320*	790*
5440	1340
78650	13730

330*	4660*
680	5890
6290	99230

S

METERED

450*
740
8830

NA
NA
NA



NA
NA
NA

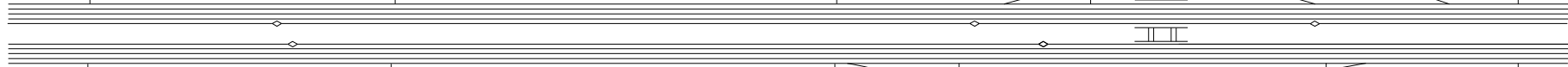

400
500
7400

METERED
340
330
5250



NA
NA
NA

METERED
480
410*
6990

S

5180*	1080*
5420*	910
91050	14780

5130*	1100*
5370*	940
90400	15380

S

1180*	5800*
1020	6070*
16740	89660

4830*	1080*
5020*	930*
83730	15250

S

5030*	770*
5270*	600
86490	9720

S

500	4520*
750	4710*
11710	90810



Washington State Department of Transportation



4 OF 31



EXIT 151
S 200TH ST
MILITARY RD

EXIT 152
S 188TH ST
ORILLIA RD

S 183RD ST

S 178TH ST

4840*	740*
5840	1400
86330	13770

680*	4700*
1330	5650*
12670	83000

690*	5600*
1330	6800*
12700	122320

5480*	630*
6680	1180
124730	11470

METERED

290*	270
590	320
6230	5080

METERED

470*	200	NA
800	260	NA
9500	3890	NA

MILITARY RD

ORILLIA RD

METERED

280	430
290*	420
4740	6420

540	710*
810	920
8770	9720

5400*	1040*
5690*	920
83490	14810

1050	5200*
810	5440*
13590	82730

1120	6270*
860*	6560*
14140	95090

5740*	980
6000*	770*
96810	12560



Washington State
Department of Transportation



5
OF
31

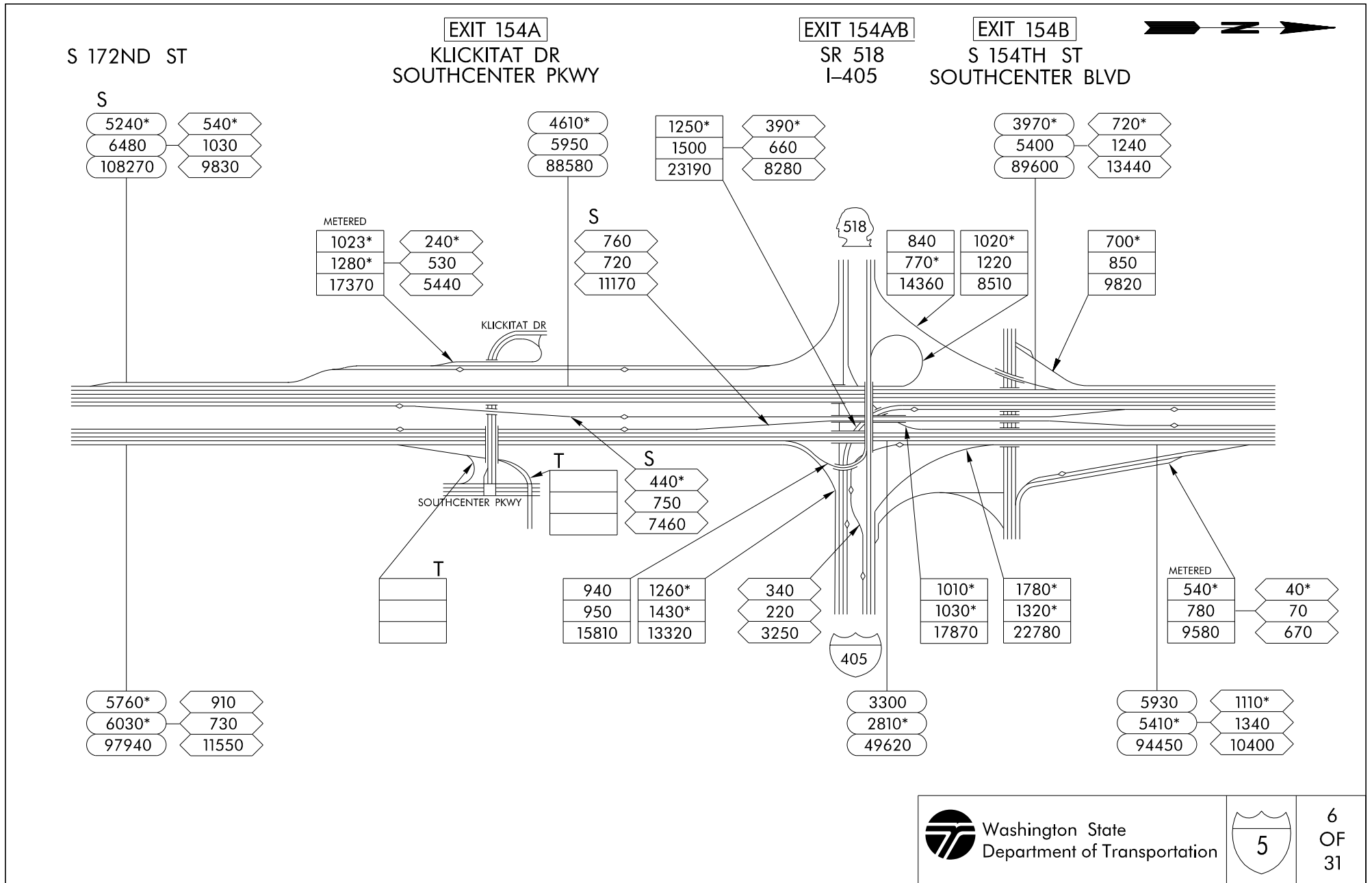



S 144TH ST

EXIT 156
SR 599

EXIT 156
INTERURBAN
AVE

S 129TH ST

S

6050*	840*
7580	1330
120500	15040

5550*	4470*
6770	5590
110960	100800

4780*	790
5600	1140*
88220	13450

S

4970*	820*
5900	1230
91520	14460

770*
1110
13230

580*
1070
10880

599

460*	160*
720	360
8510	3520

220*
390
4100

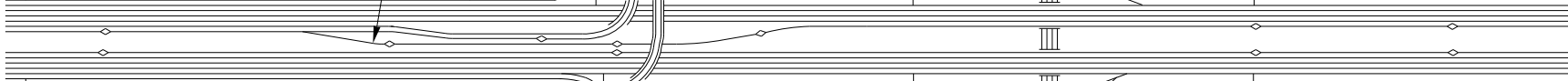

1790
1390*
24290

60	METERED
90	300
1180	360
	4830

S

6140	750
6000*	760*
103340	11840

4510*	780
4600*	780*
78720	12250

4550*	840
4640	830*
77990	13140

S

4800*	860
4920*	870*
83560	13720



Washington State
Department of Transportation



7
OF
31

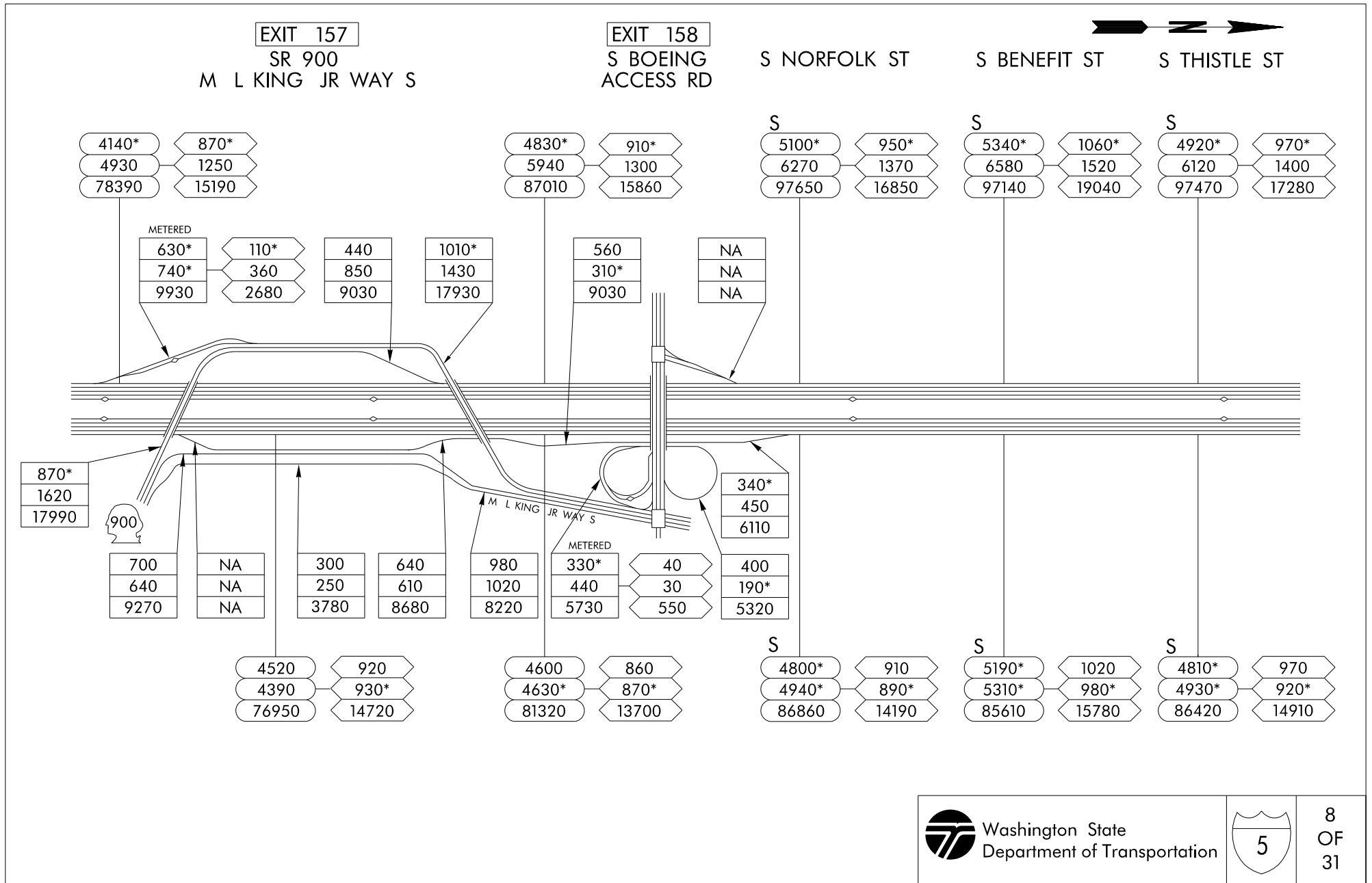



EXIT 161

EXIT 162

S HOLDEN ST

S HOLLY ST

S ALBRO PL
SWIFT AVE S

CORSON AVE S
S MICHIGAN ST

S PEARL ST

S OREGON ST

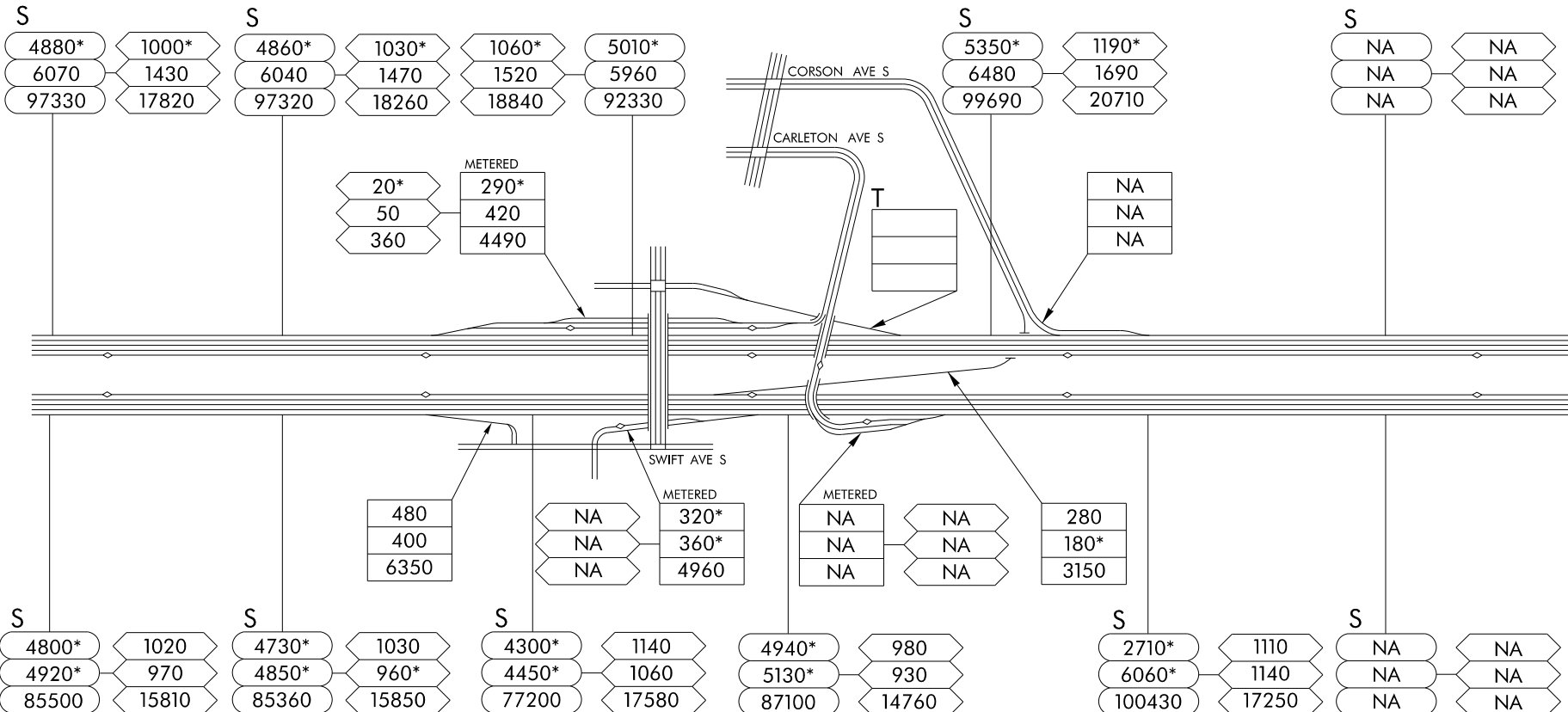

	Washington State Department of Transportation		9 OF 31
--	--------------------------------------------------	--	---------------

EXIT 163/163A

EXIT 163B

S SPOKANE ST
COLUMBIAN WY
WEST SEATTLE BRIDGE

S FOREST ST

S HOLGATE ST

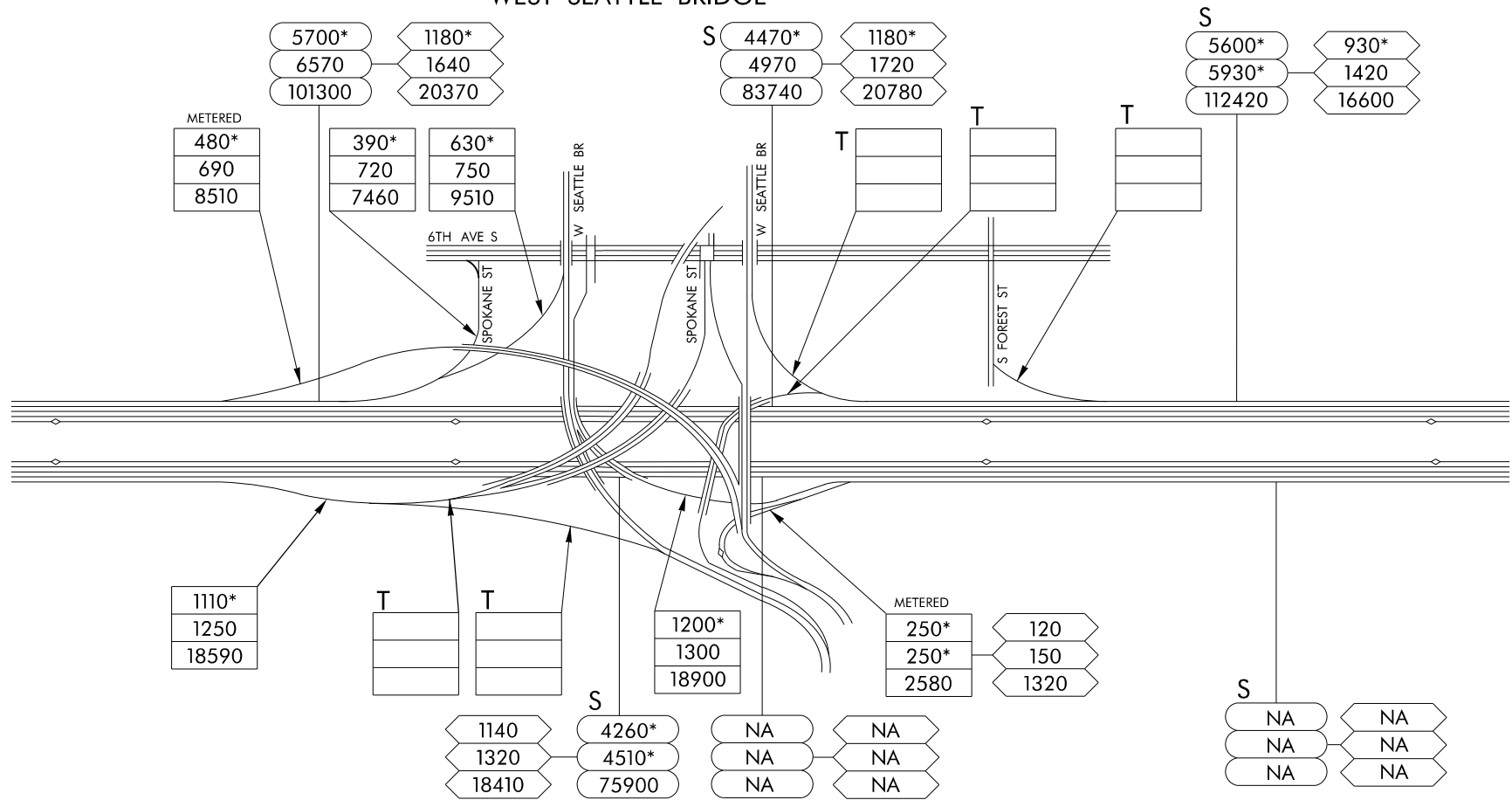

	Washington State		10 OF 31
	Department of Transportation		

EXIT 164A
COLLECTOR-DISTRIBUTOR

EXIT 164B
4TH AVE S DEARBORN ST

YESLER WAY JAMES ST

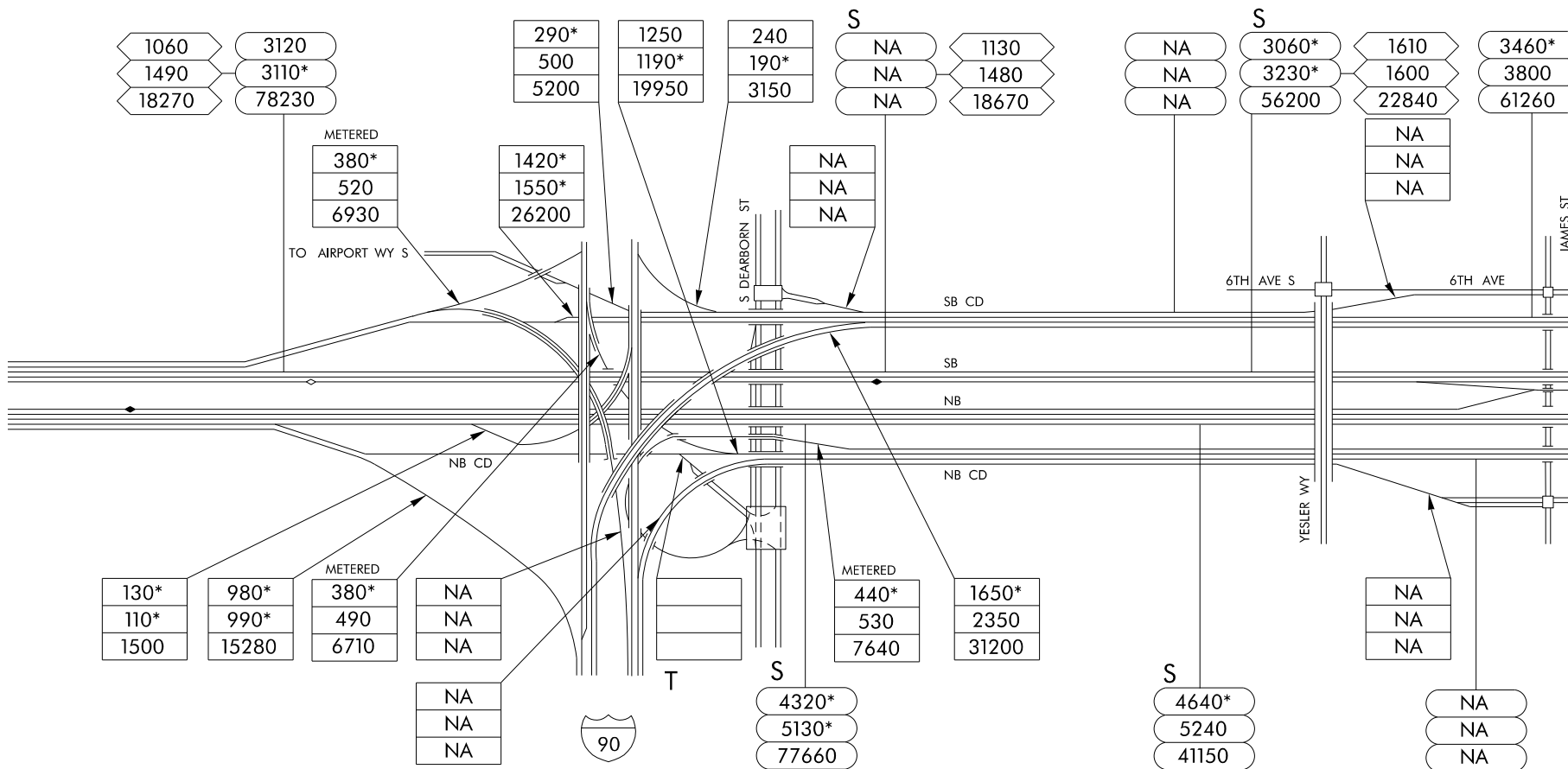

* es16466_MMN_Stn includes only lanes 1 and 2 for metering purposes.
*_MN_Stn includes only lanes 3 and 4.

	Washington State		11
	Department of Transportation		OF
			31

CHERRY ST

MADISON ST

UNIVERSITY ST

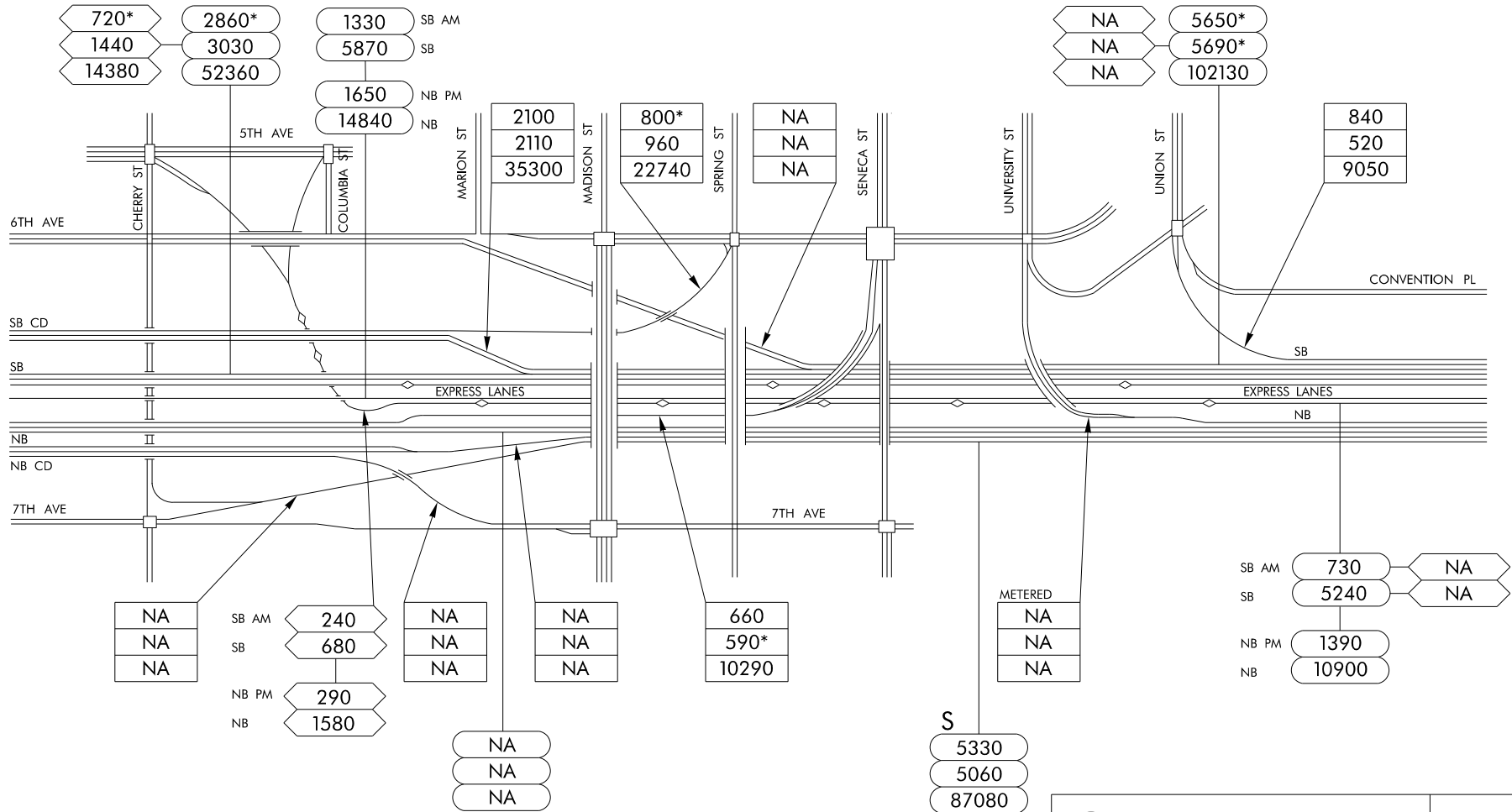

Washington State Department of Transportation



12 OF 31

EXIT 166
STEWART ST

EXIT 167
MERCER ST

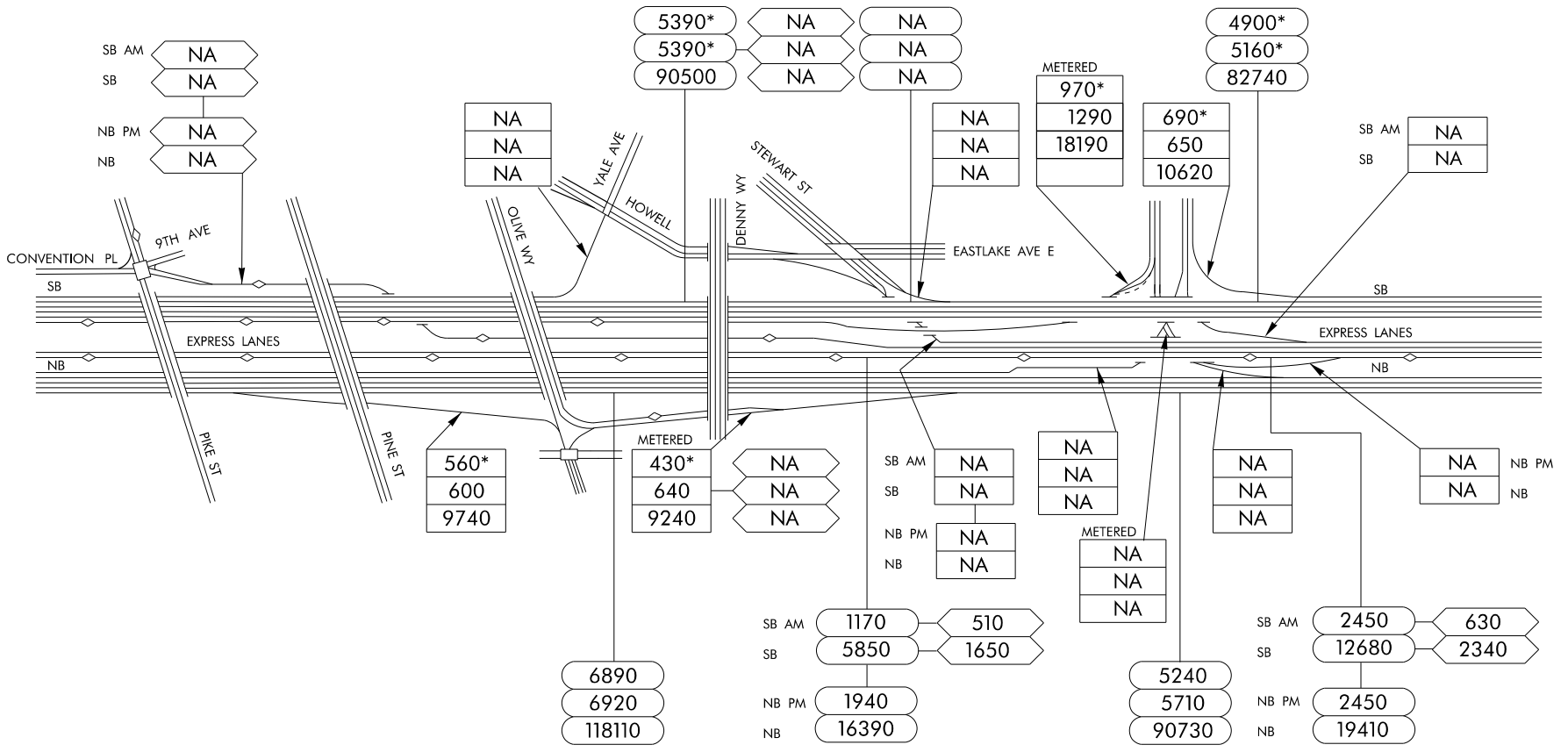

	Washington State Department of Transportation		13 OF 31

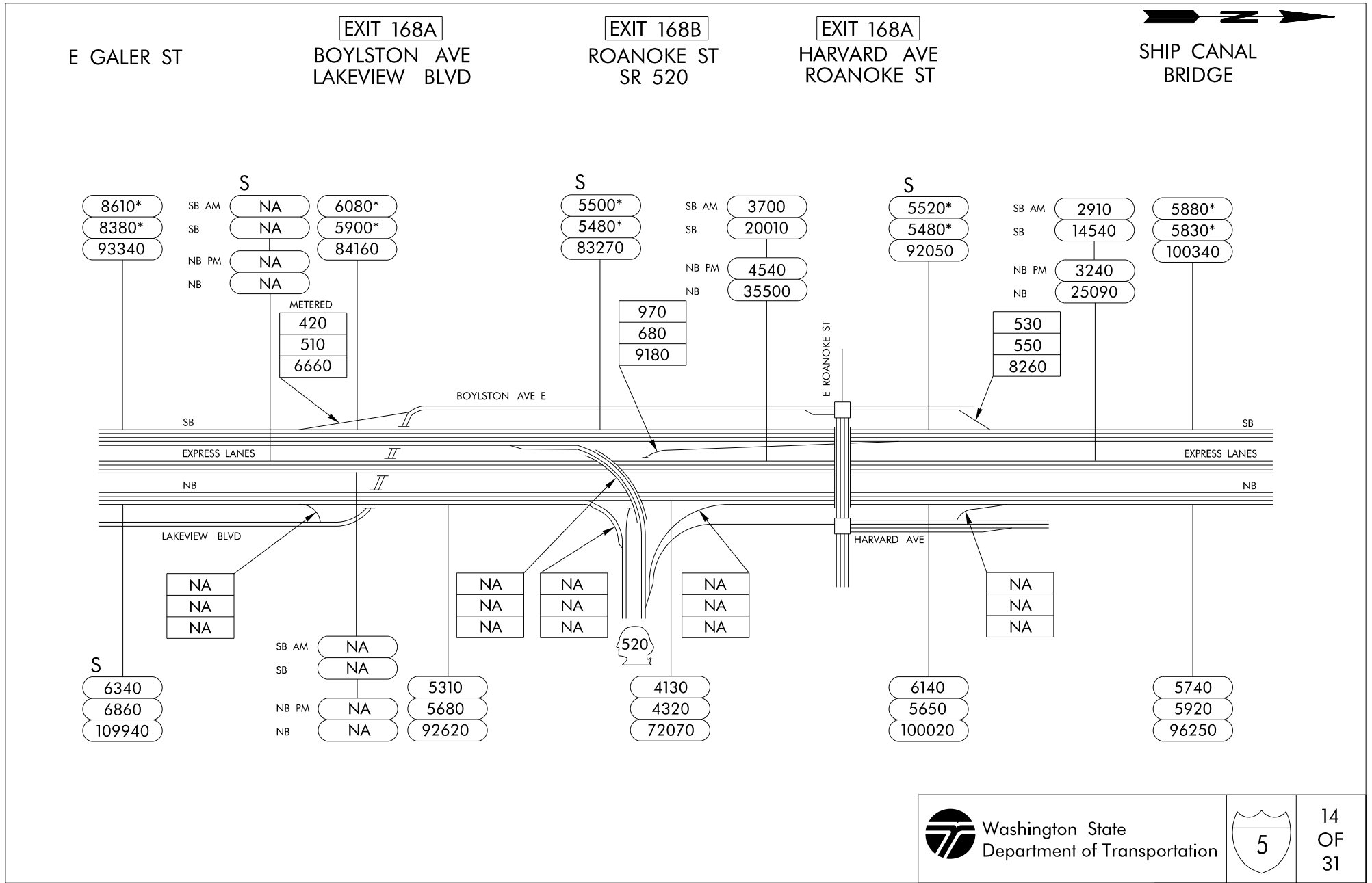

NE 42ND ST

EXIT 169
NE 45TH ST
NE 50TH ST

RAVENNA BLVD

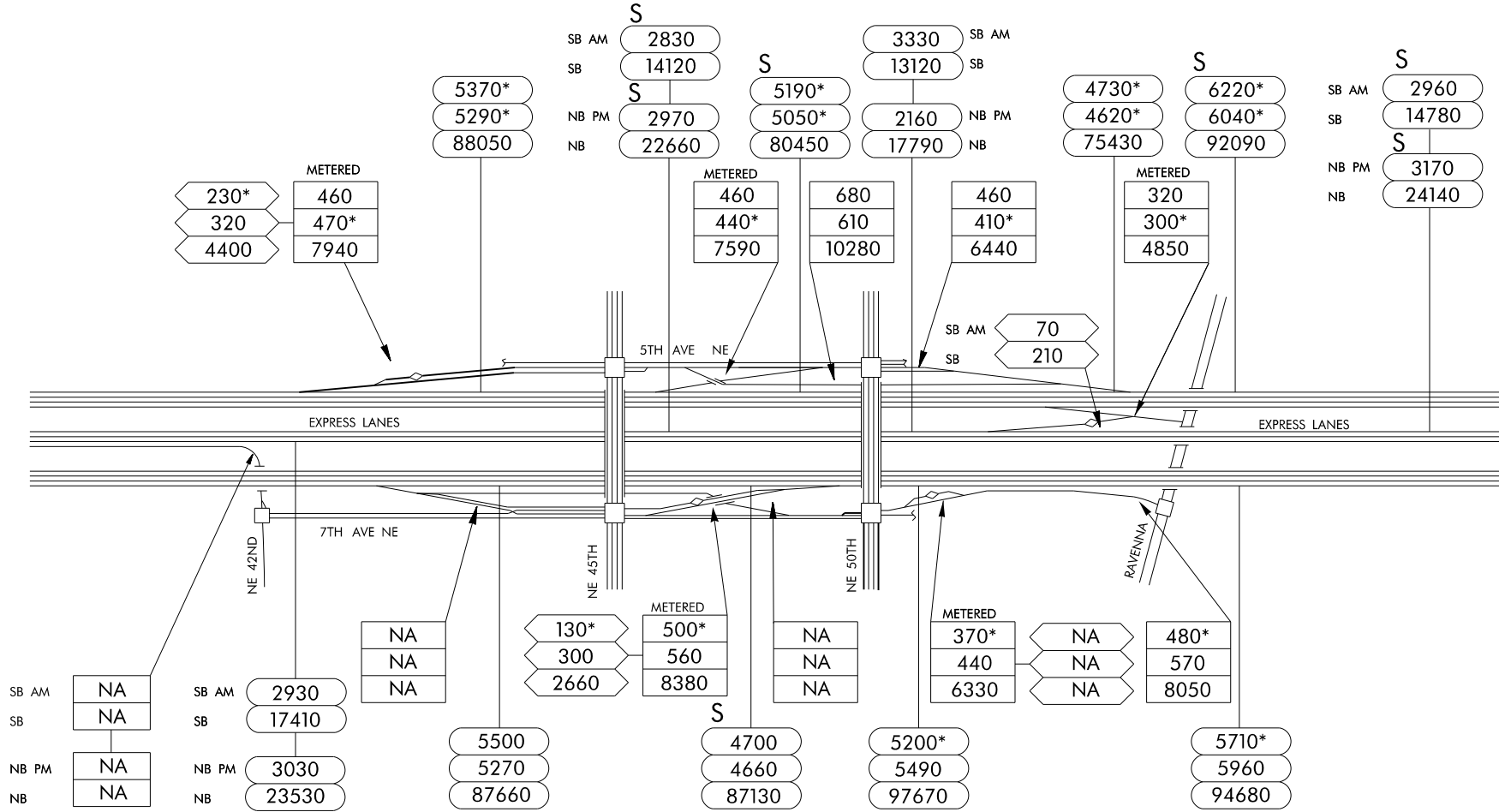

	Washington State Department of Transportation		15 OF 31
--	--------------------------------------------------	--	----------------

EXIT 171
NE 70TH ST
LAKE CITY WY

EXIT 172
NE 80TH ST
NE 85TH ST

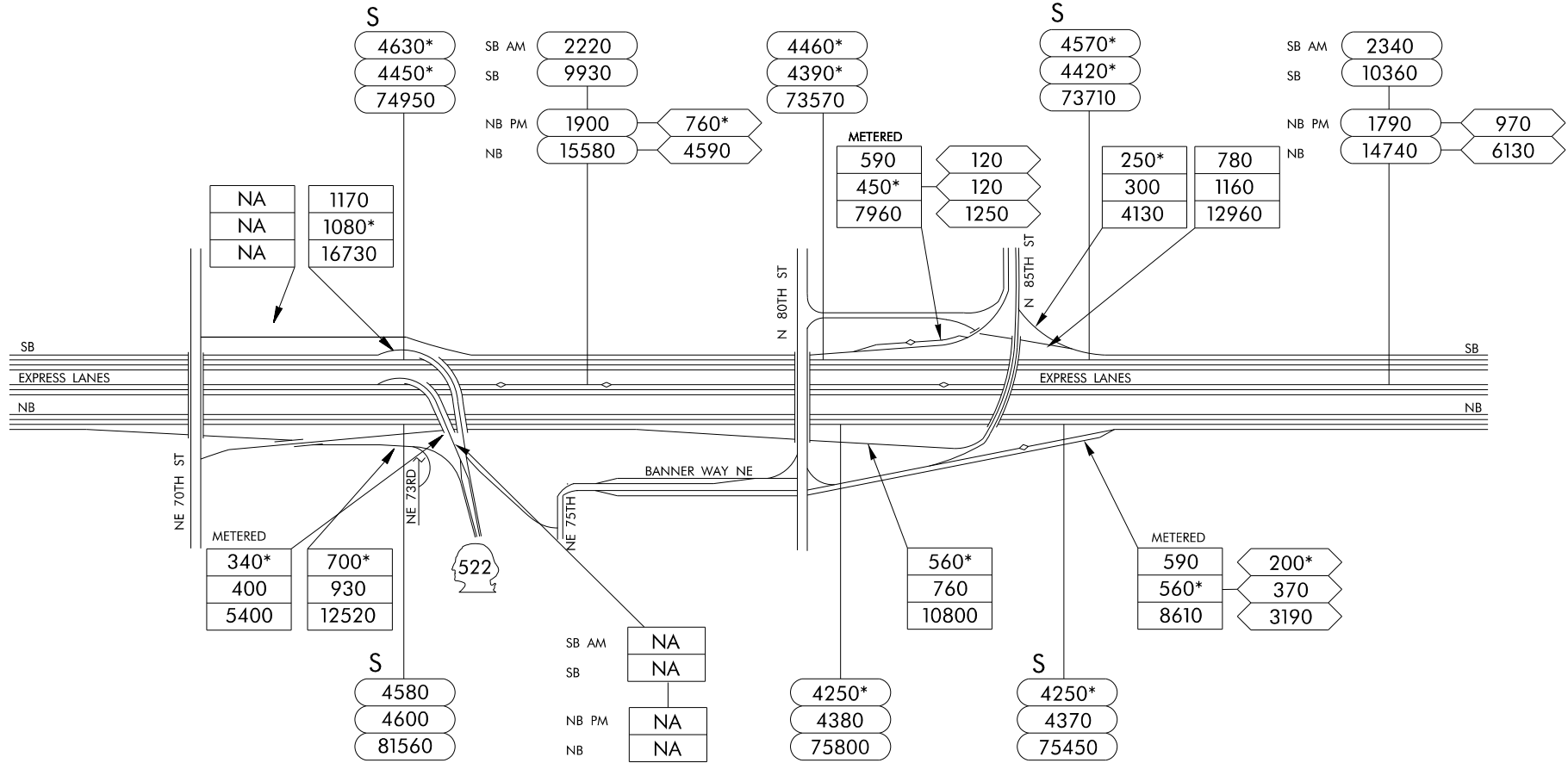

NE 92ND ST



EXIT 173

NE NORTHGATE WY

NE 120TH ST

EXIT 174

NE 130TH ST

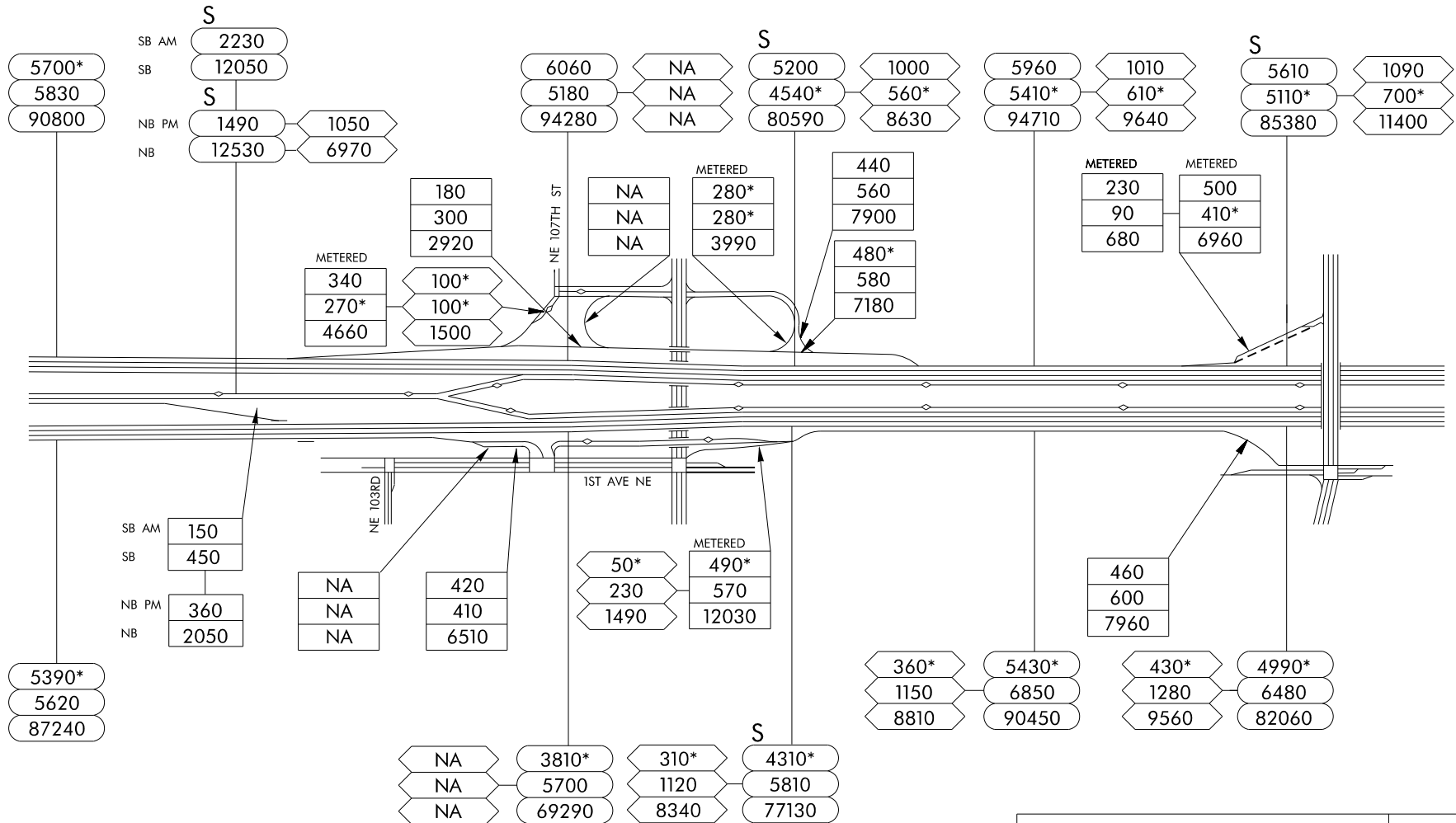

	Washington State		17
	Department of Transportation		OF
			31

EXIT 175

EXIT 176

NE 137TH ST

SR 523
NE 145TH ST

NE 155TH ST

METRO
NORTH BASE

NE 175TH ST

7060
6080*
84220

1070
760*
12420

S
4460
4080*
70410

1110
830*
13690

4930
4640*
81040

1150
920
14810

S
5190
4900
80030

1210
980
15640

1130
950
14940

4400
4190
71900

1050
930
13730

4480
4580
79530

1050
630*
11560

523

670*
950
11720

NA
NA
NA

METRO ONLY
30*
30
310

METRO ONLY
40*
20
190

METERED
460*
460*
6800

240
110*
2100

400*
510
6390

5TH AVE NE

570*
870
11330

S
4200*
5230
73140

450*
1230
9960

METERED
520*
570*
7310

80*
220
1880

METRO ONLY
20
20
340

METRO ONLY
NA
NA
NA

EXIT TO
NE 175TH
ONLY
490*
690
8920

METERED
440*
490*
6890

40*
230
1280

4910*
5960
86820

NA
NA
NA

4830*
5870
82160

450*
1260
10150

S
5040*
6070
81160

490*
1380
11050

NA
NA
NA

4370*
4810
74780



Washington State
Department of Transportation



18
OF
31

NE 195TH ST

EXIT 177
SR 104
NE 205TH ST



EXIT 178
236TH ST SW

228TH ST SW 220TH ST SW

EXIT 179

213TH ST SW

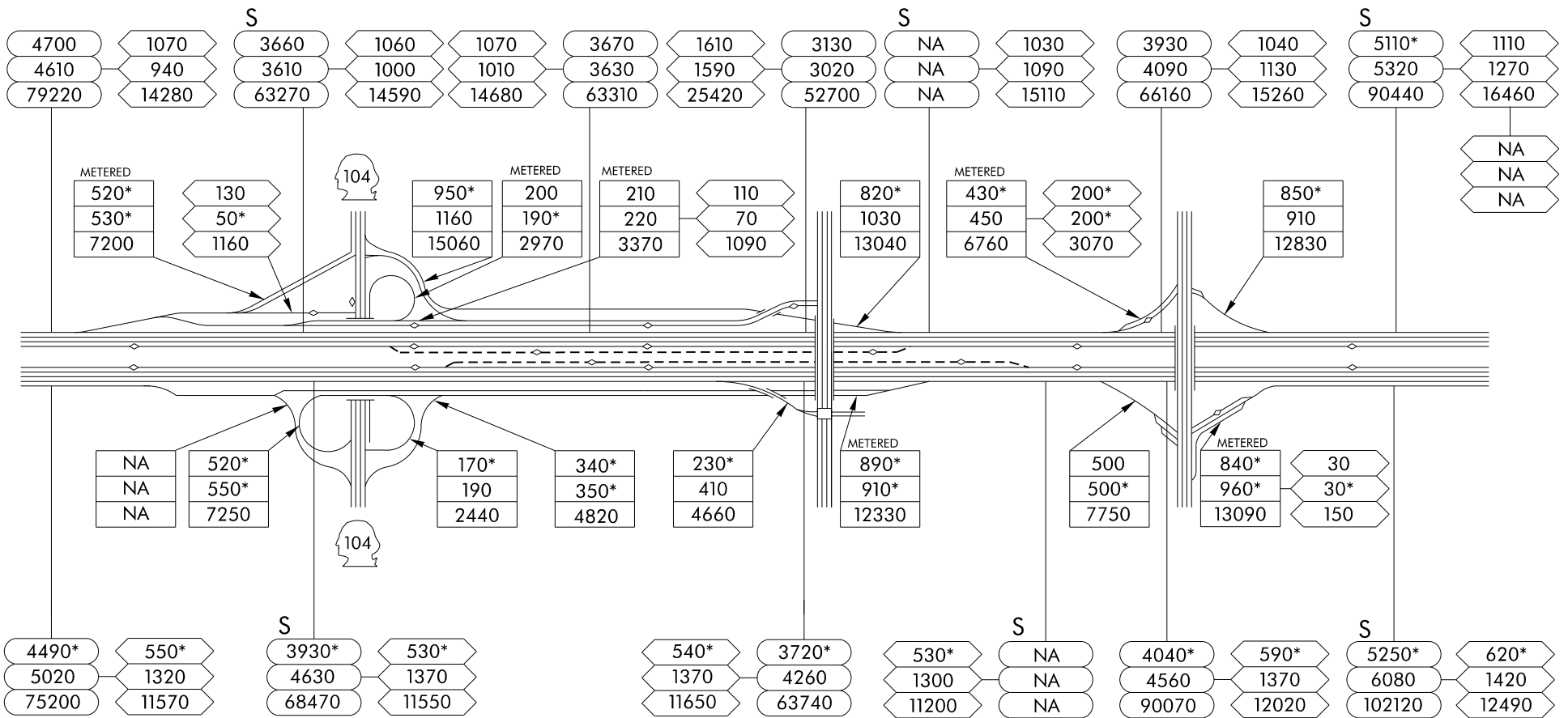

	Washington State		19
	Department of Transportation		OF
			31

208TH ST SW

LYNNWOOD
PARK & RIDE
DIRECT ACCESS

EXIT 181A

44TH AVE W

EXIT 181/181B

ALDERWOOD MALL PKWY
196TH ST SW

EXIT 182

28TH AVE W

I-405
SR 525

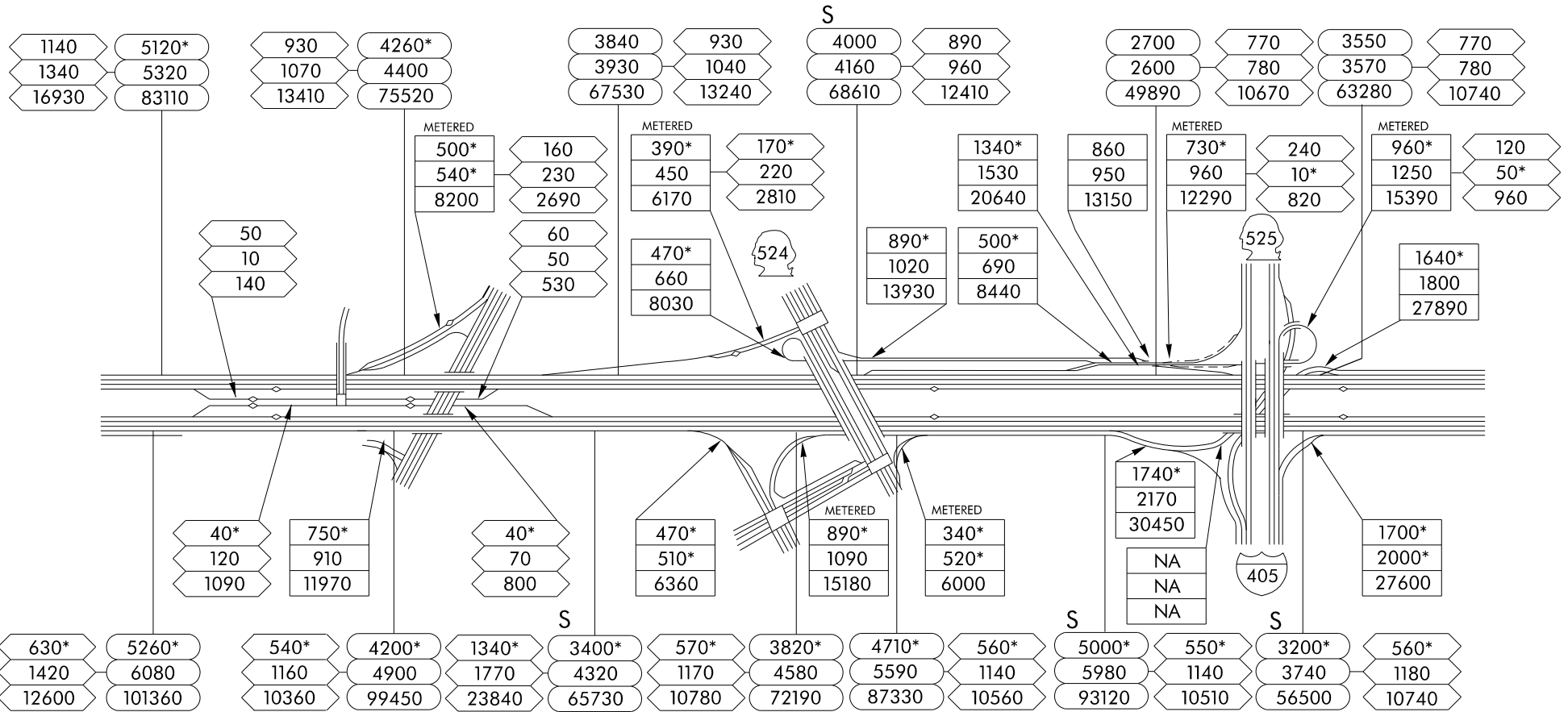

	Washington State Department of Transportation		20
			OF
			31

EXIT 183



175TH ST SW

164TH ST SW

ASHWAY
PARK & RIDE
DIRECT ACCESS

156TH ST SW

148TH ST SW

140TH ST SW

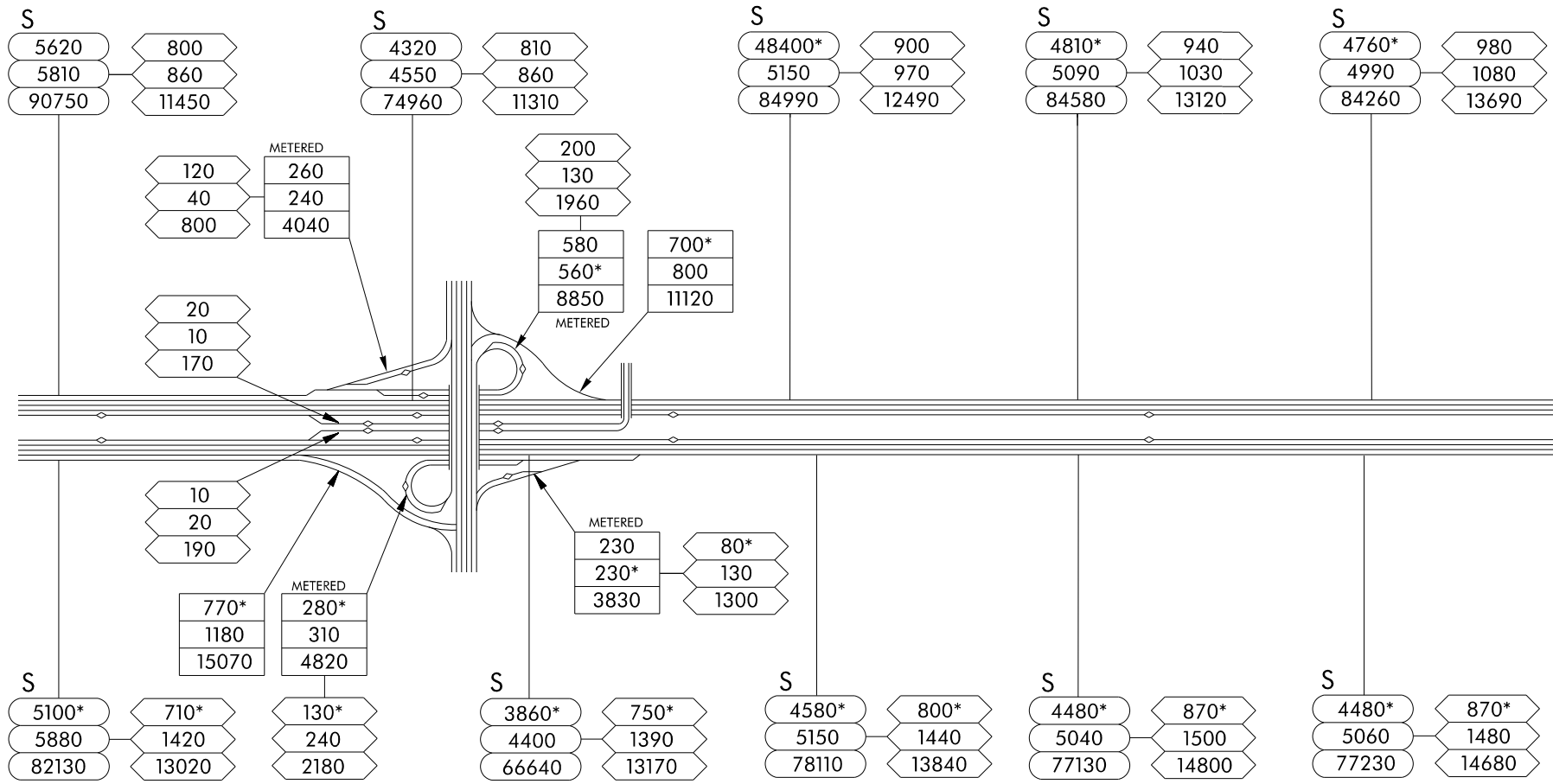

	Washington State Department of Transportation		21 OF 31
--	--------------------------------------------------	--	----------------

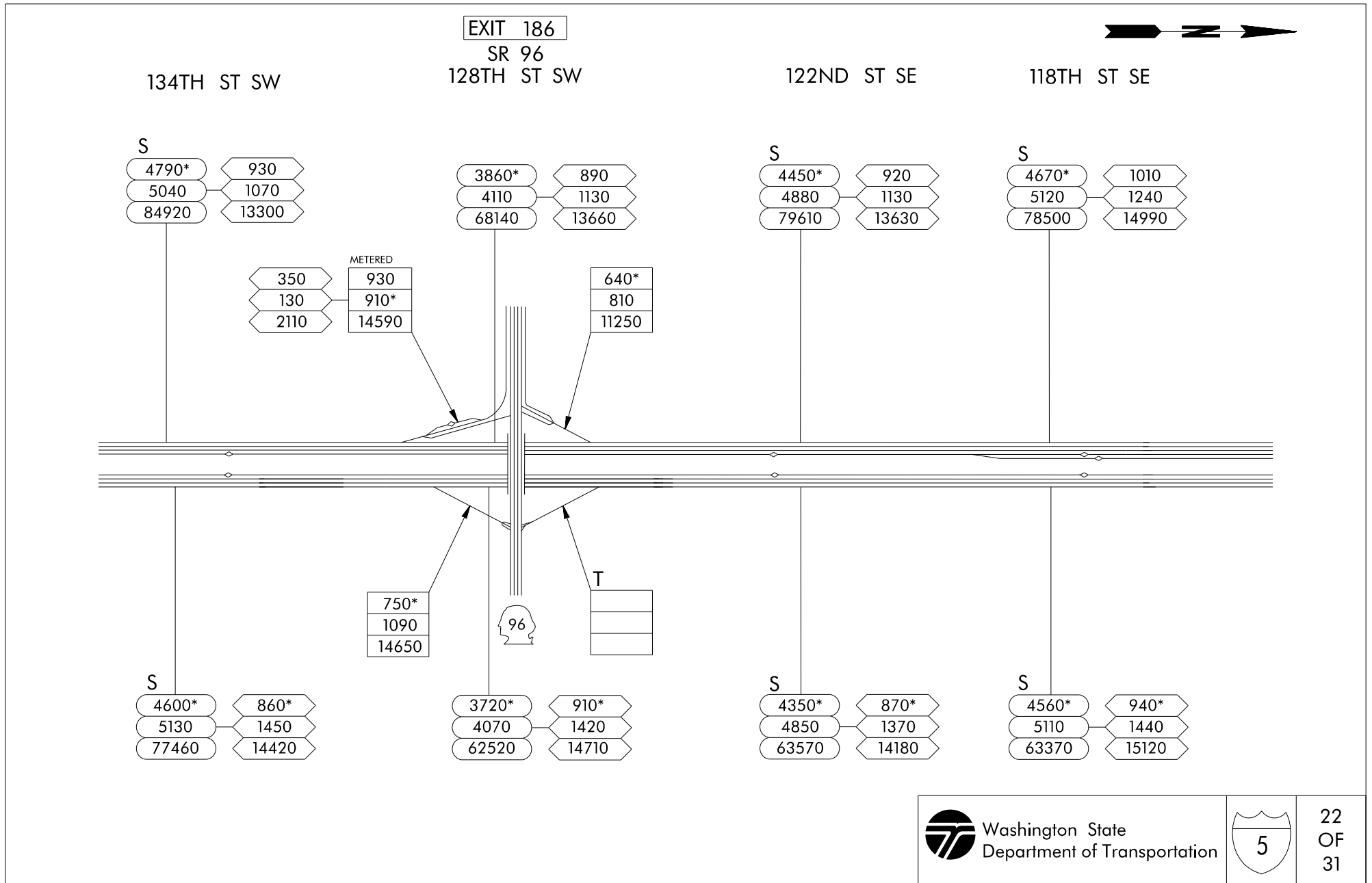

112TH ST SE
PARK & RIDE

106TH ST SE

EVERETT MALL
WAY

EXIT 189

SR 526
SR 99, SR 527



77TH ST SE

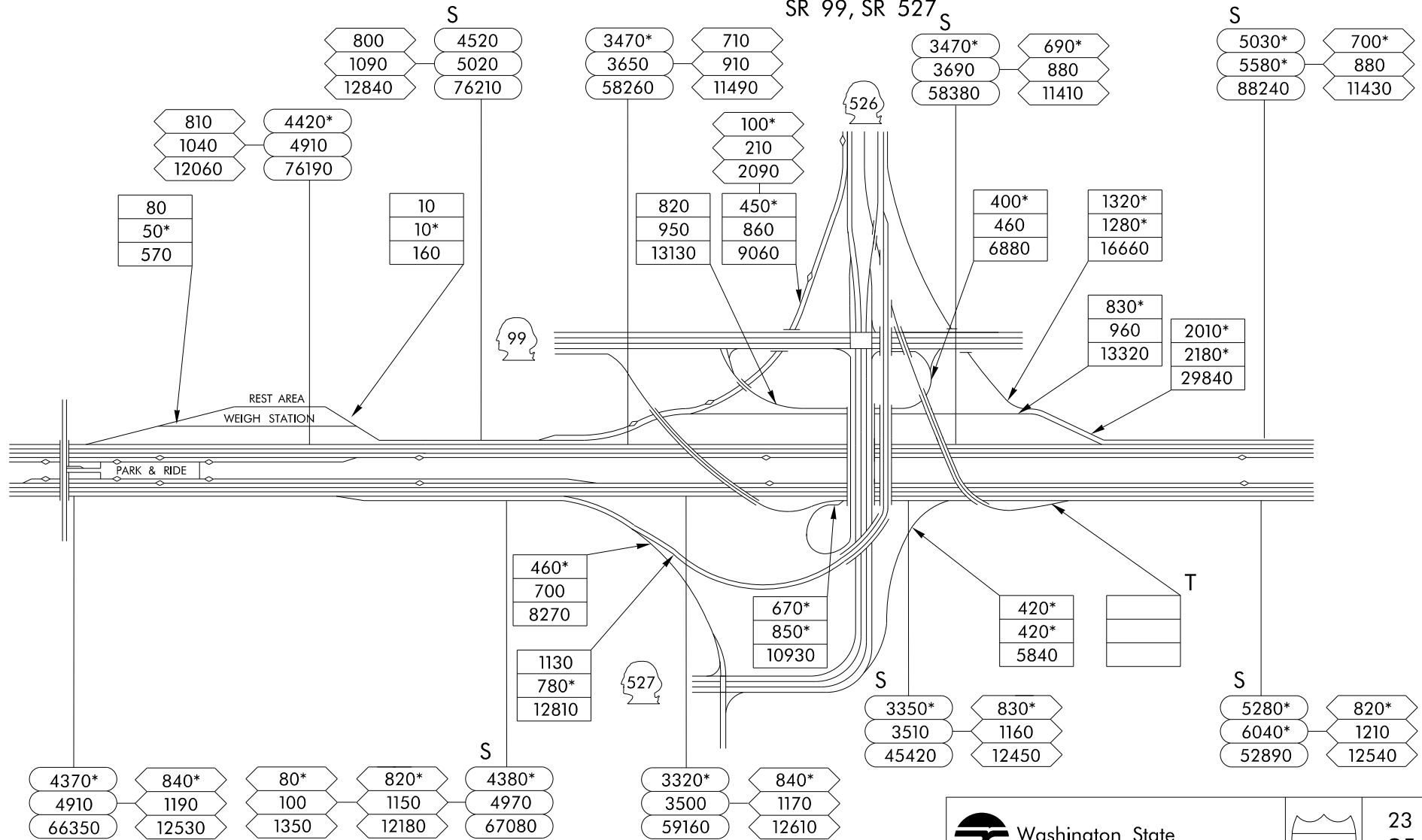

Washington State
Department of Transportation



23
OF
31

73RD ST SE

S

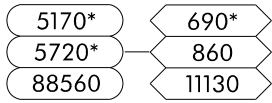

LEXINGTON AVE SE

S

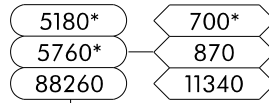

LINCOLN ST



S

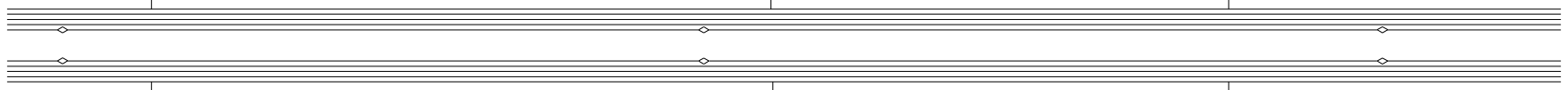
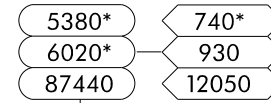

S

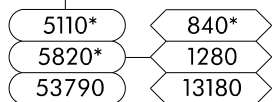

S

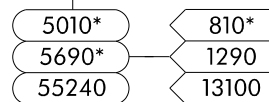

S

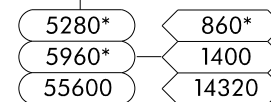

	Washington State Department of Transportation		24 OF 31
--	--------------------------------------------------	--	----------------

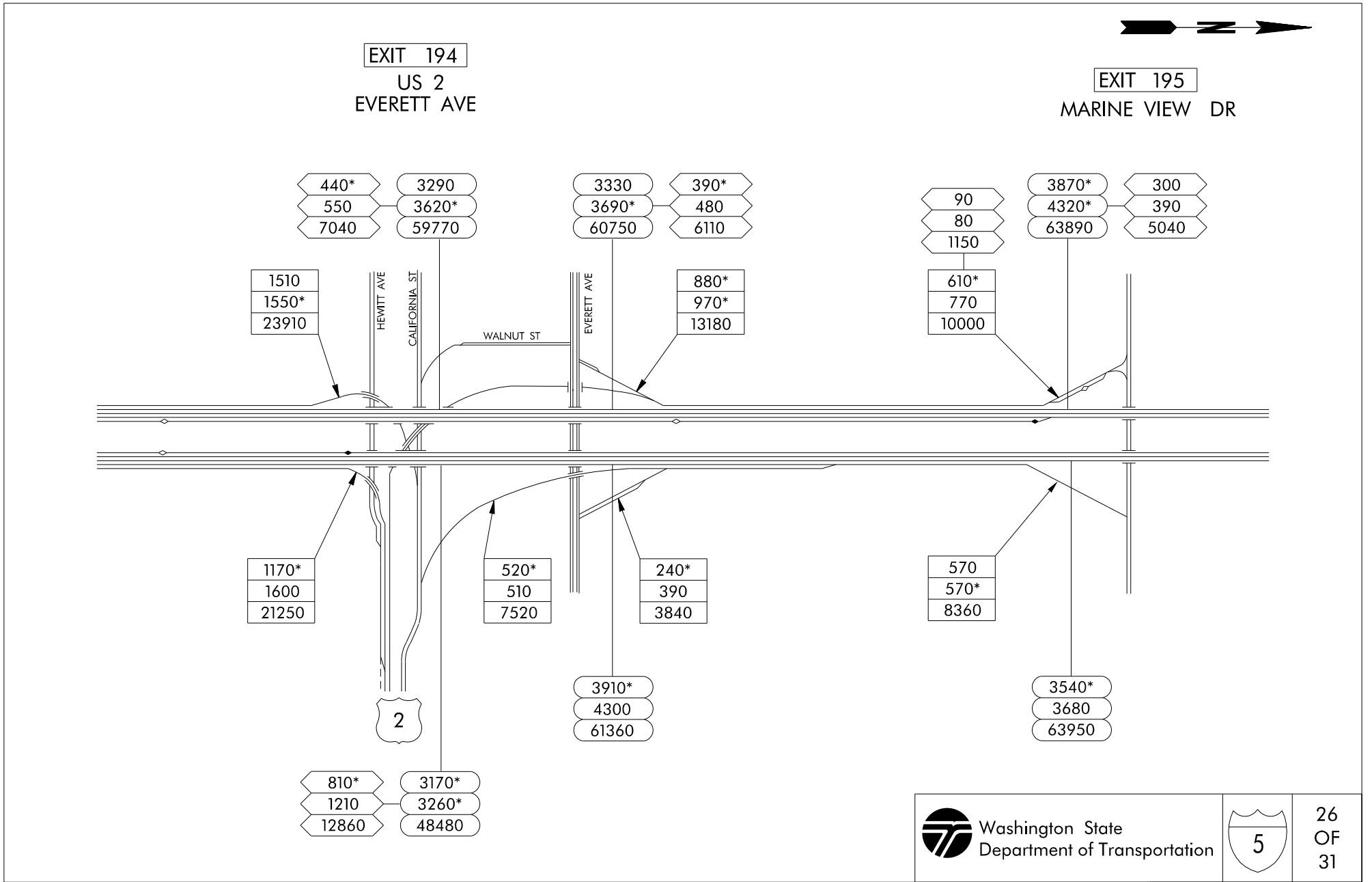

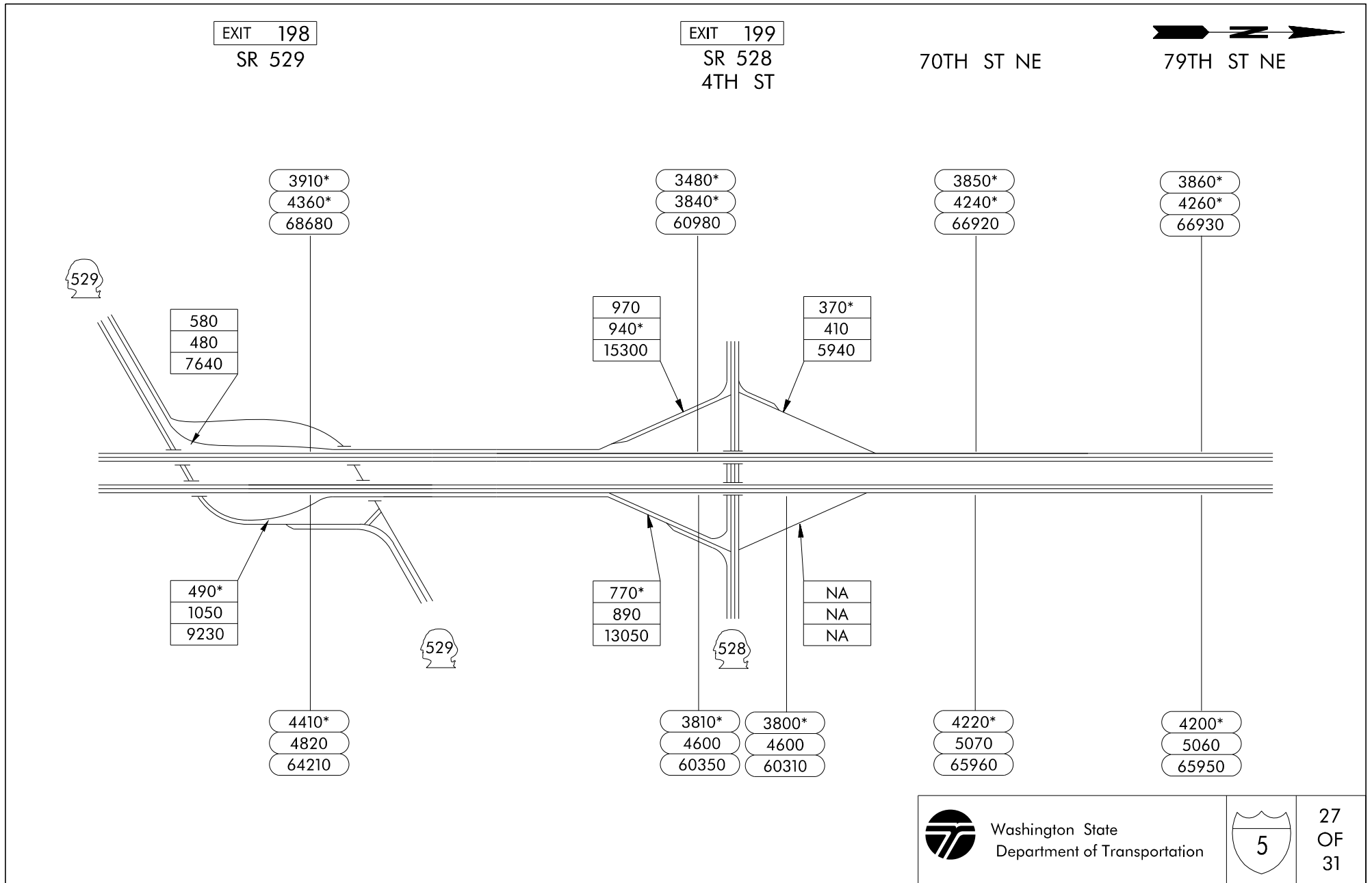

EXIT 200
88TH ST NE
QUIL CEDA WAY

98TH ST NE

105TH ST NE

EXIT 202
116TH ST NE

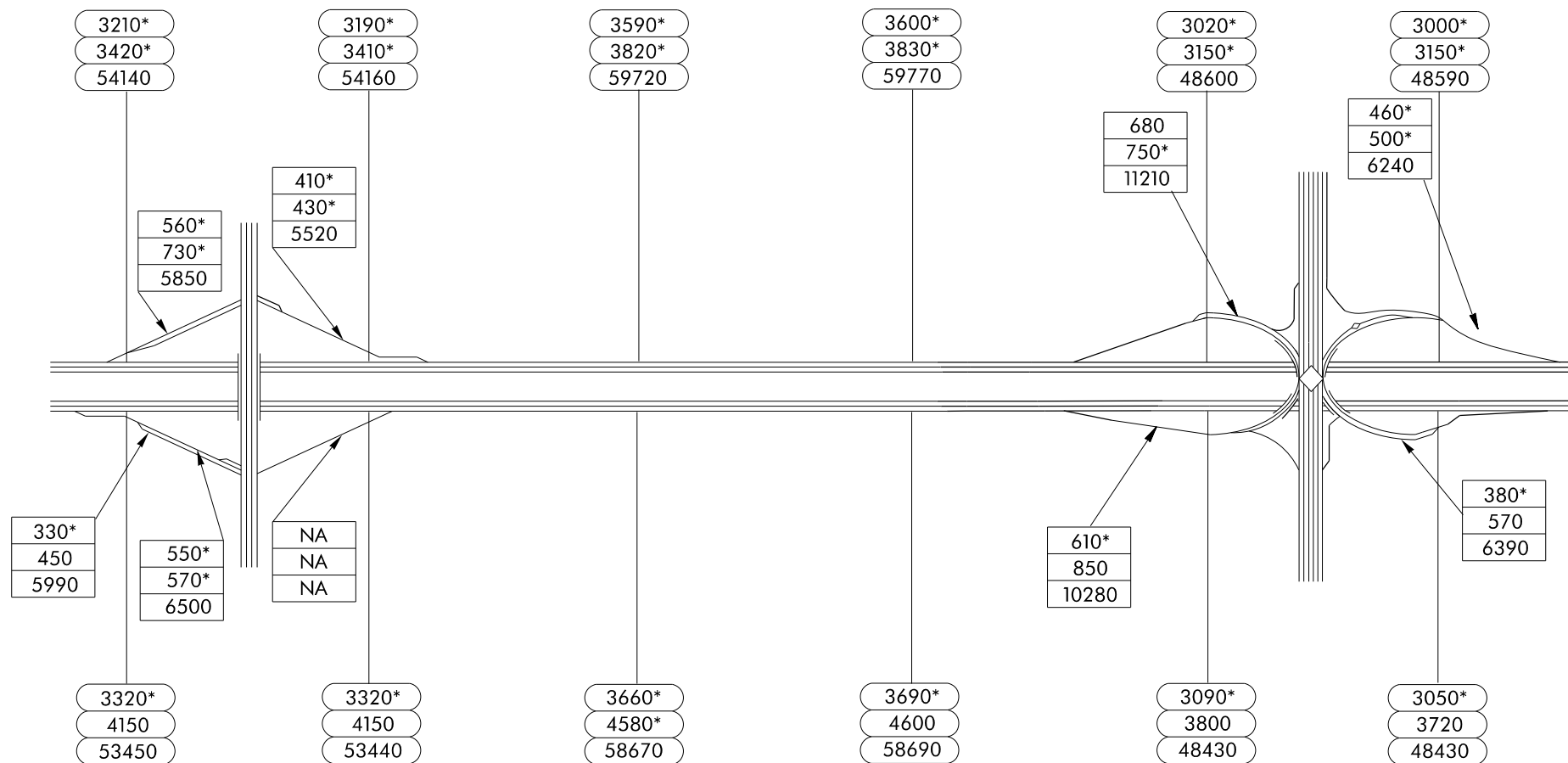

	<p>Washington State Department of Transportation</p>		<p>28 OF 31</p>
--	----------------------------------------------------------	--	-------------------------



127TH ST NE

136TH ST NE

144TH ST NE

152ND ST NE

160TH ST NE

3310*
3510*
54830

3440*
3610*
54950

2420*
2490*
54970

3450*
3620*
55850

3540*
3710*
55920

3300*
4250
54720

3420*
4280
54720

3450*
4340
54740

3480*
4340
54790

3500*
4380
54840



Washington State
Department of Transportation



29
OF
31

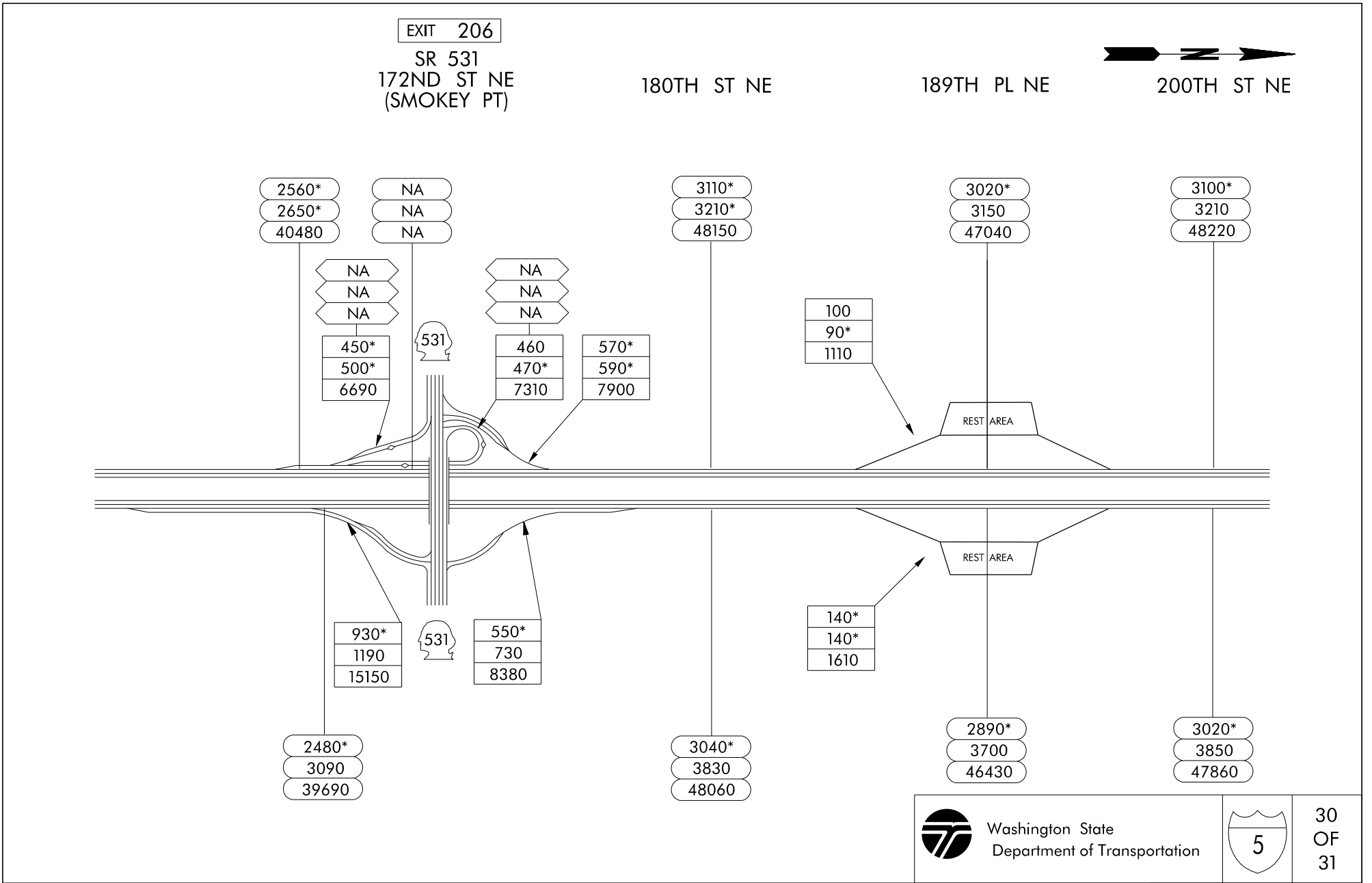

EXIT 208

204TH ST NE

SR 530
PIONEER HWY

STILLAGUAMISH
RIVER

236TH ST NE



3120*
3210
48220

2690*
2830
41370

2680*
2820
41350

2980*
3210
45970

2640*
2830
40810

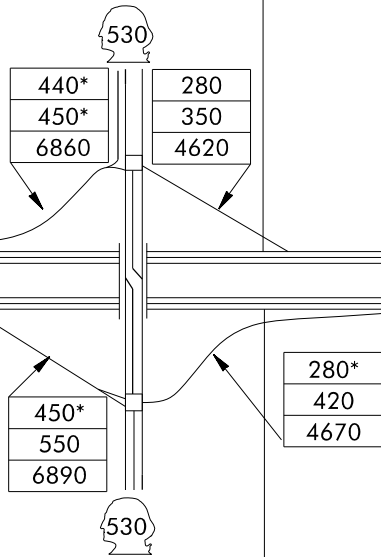

290*
320
5130

450*
550
6890

280*
420
4670

310*
440
5240

3030*
3820
47860

2580*
3270
40970

2580*
2820
40970

2900*
3740
45560

2540*
3240
40420



Washington State
Department of Transportation



31
OF
31

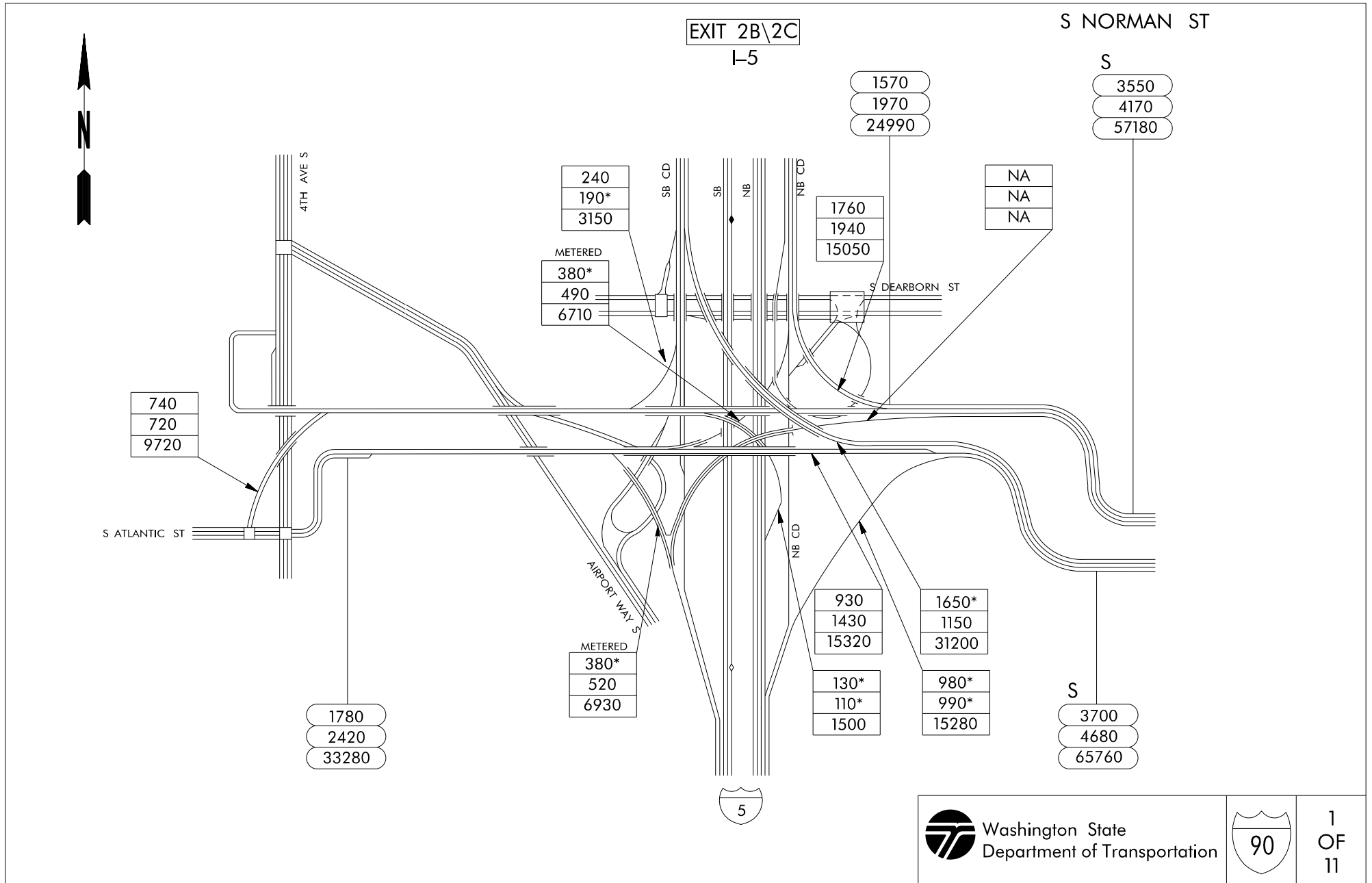

EXIT 3A\ 3B
RAINIER AVE S

23RD AVE S

35TH AVE S

WEST HIGHRISE

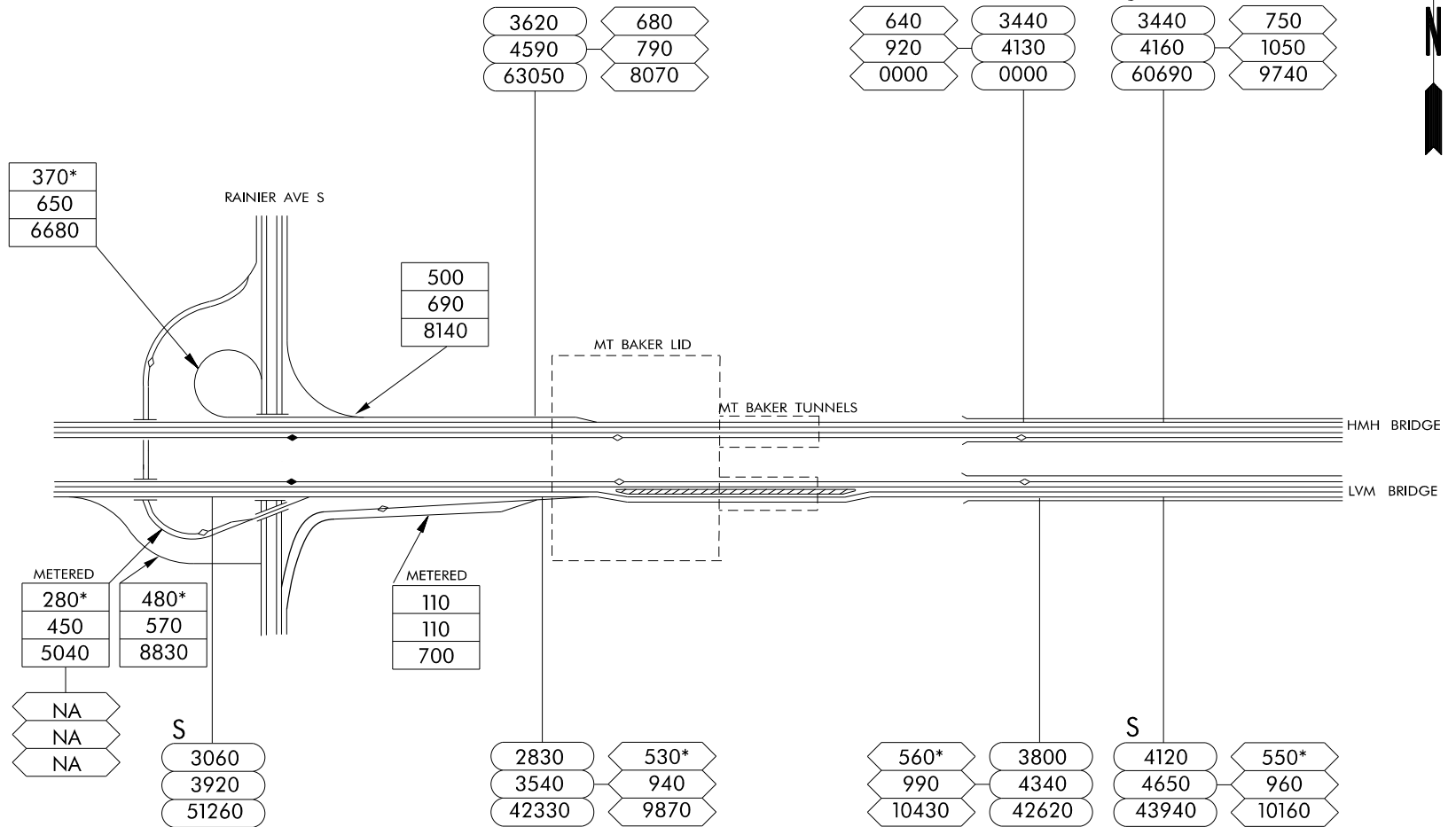

	Washington State		2 OF 11
	Department of Transportation		



MIDSPAN

EAST HIGHRISE

EXIT 6A
W MERCER WY

76TH AVE SE

77TH AVE SE

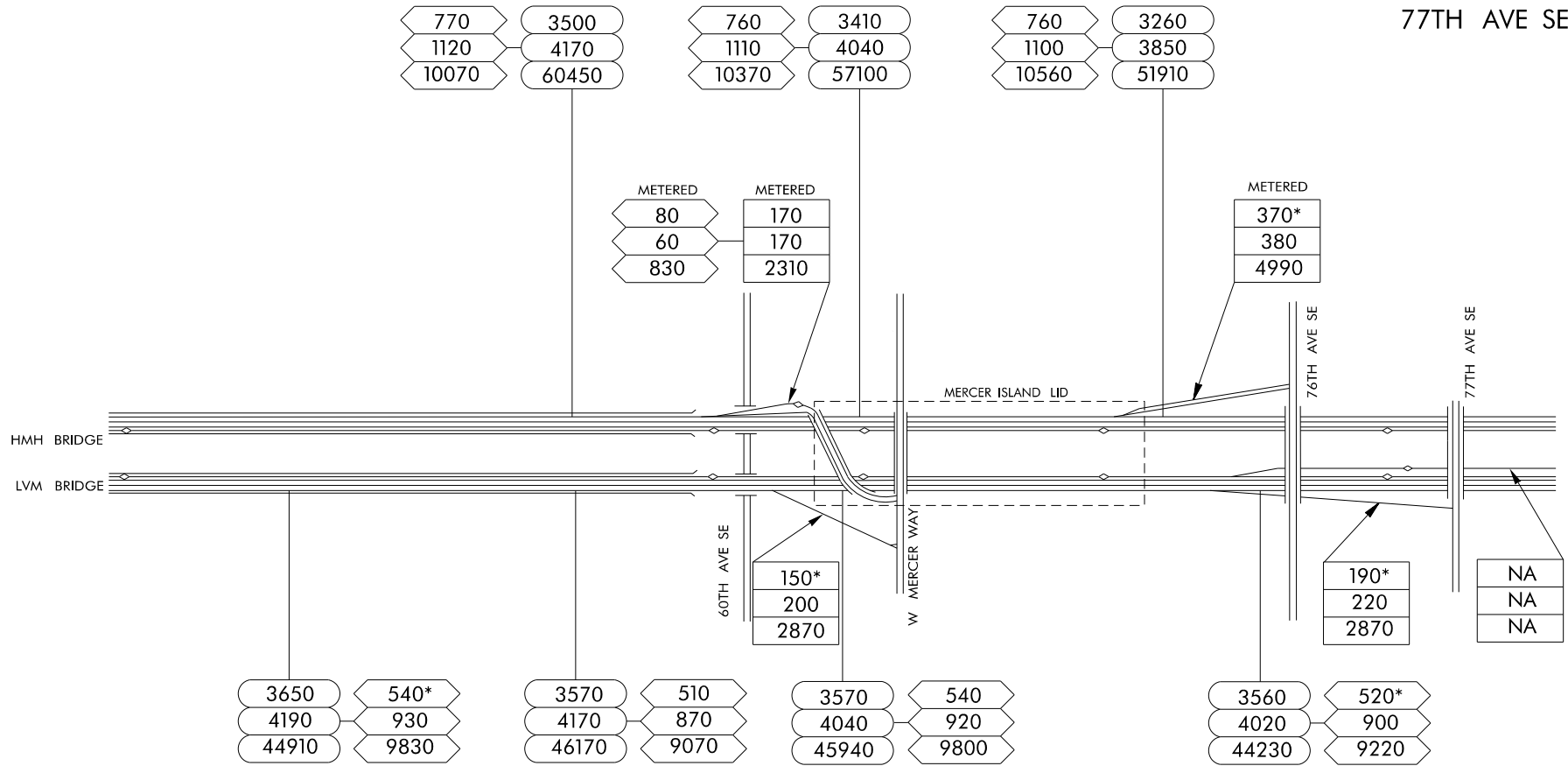

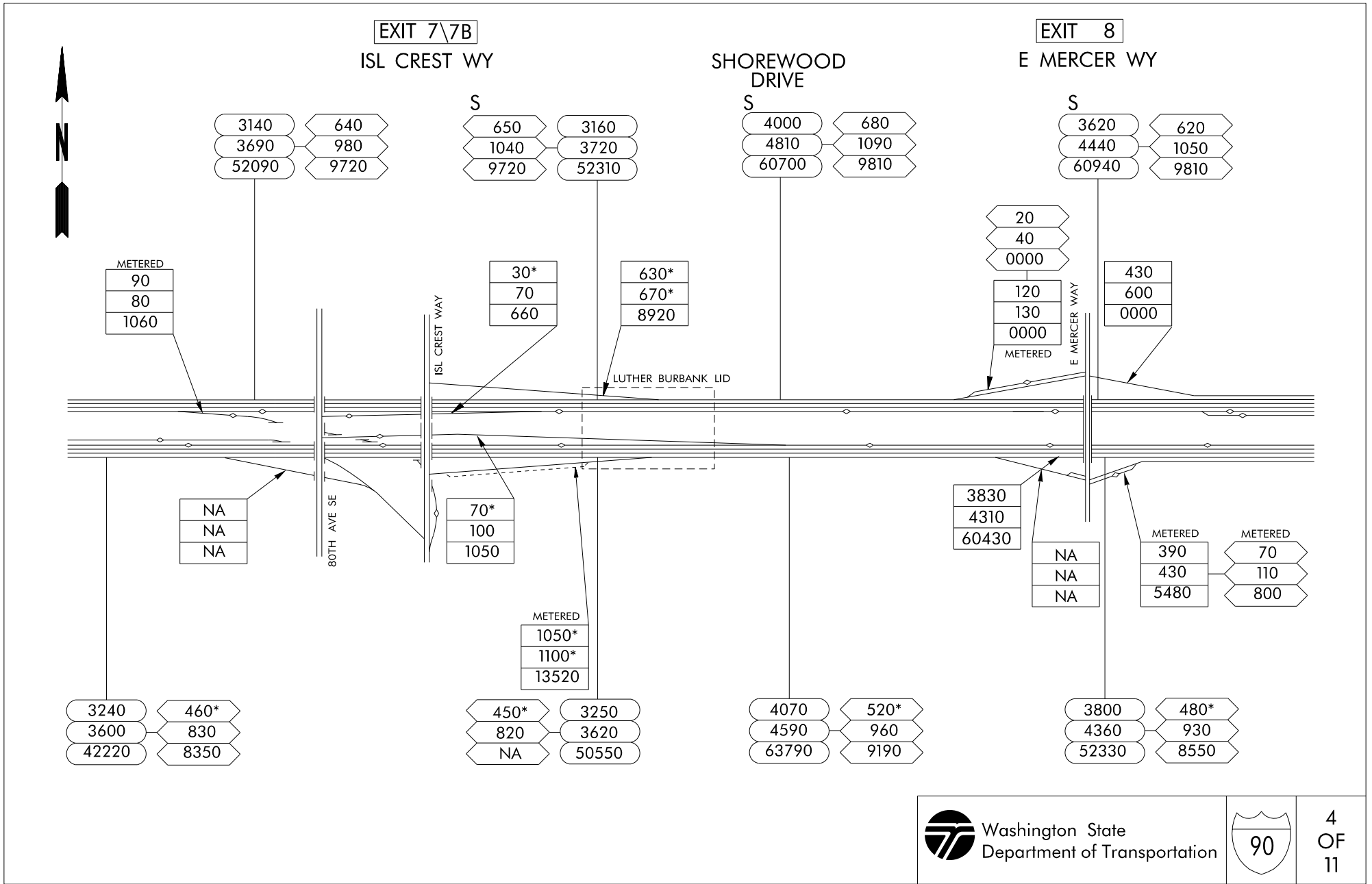

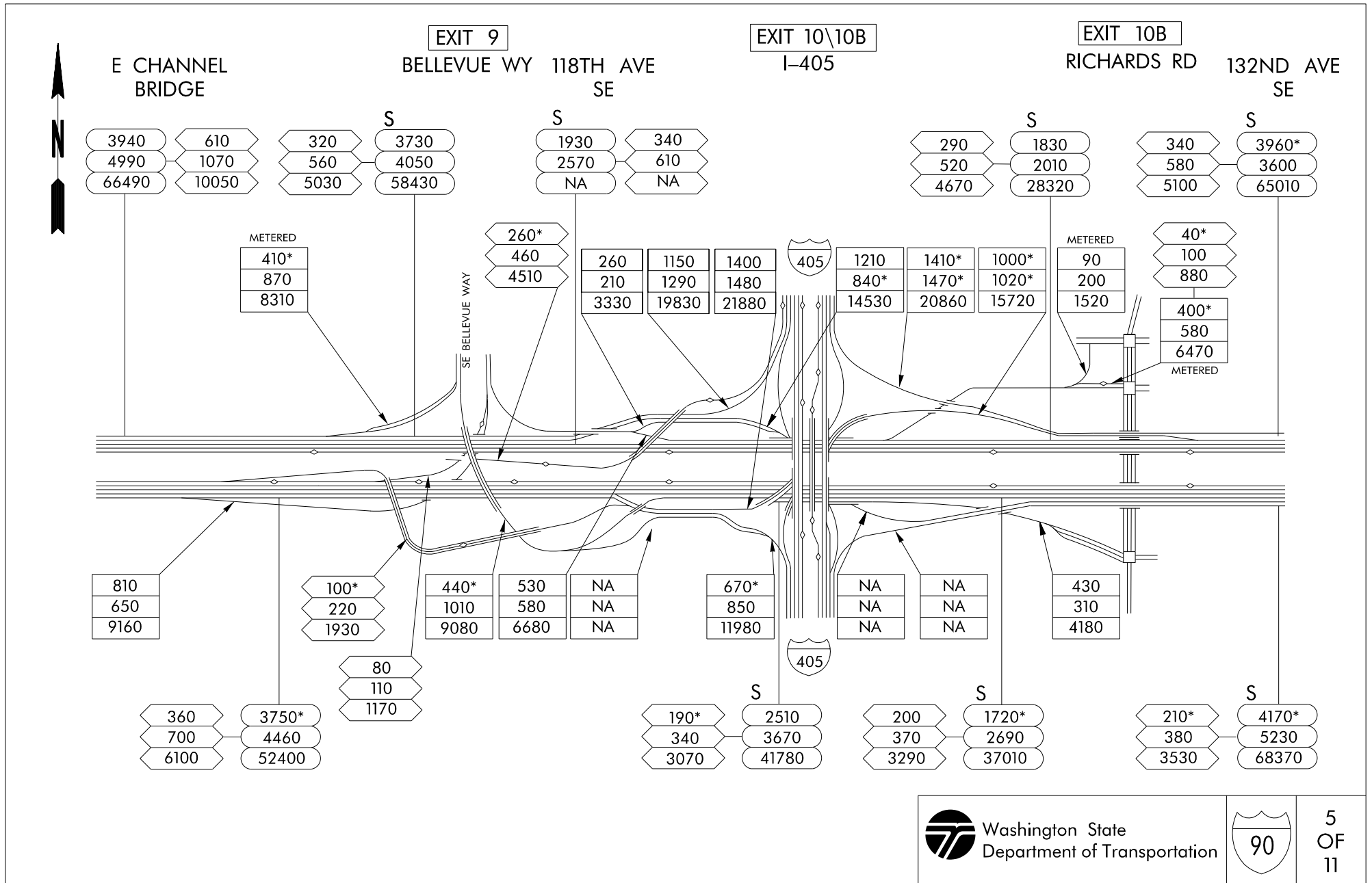

142ND PL SE
PARK & RIDE
DIRECT ACCESS

EXIT 11A\B
148TH AVE SE
150TH AVE SE

EXIT 11
161ST AVE SE
S

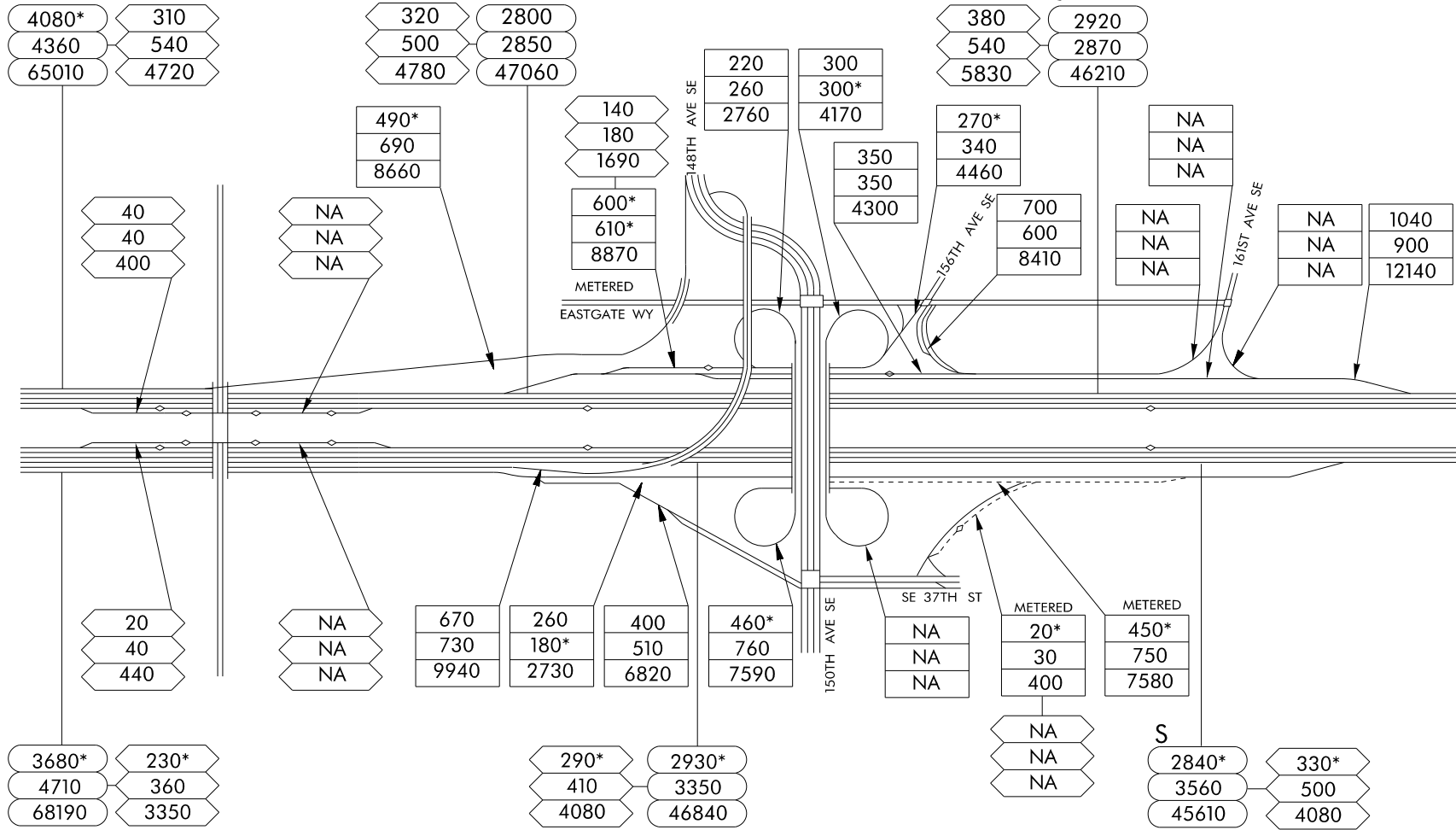

	Washington State Department of Transportation		6 OF 11
--	--------------------------------------------------	--	---------------

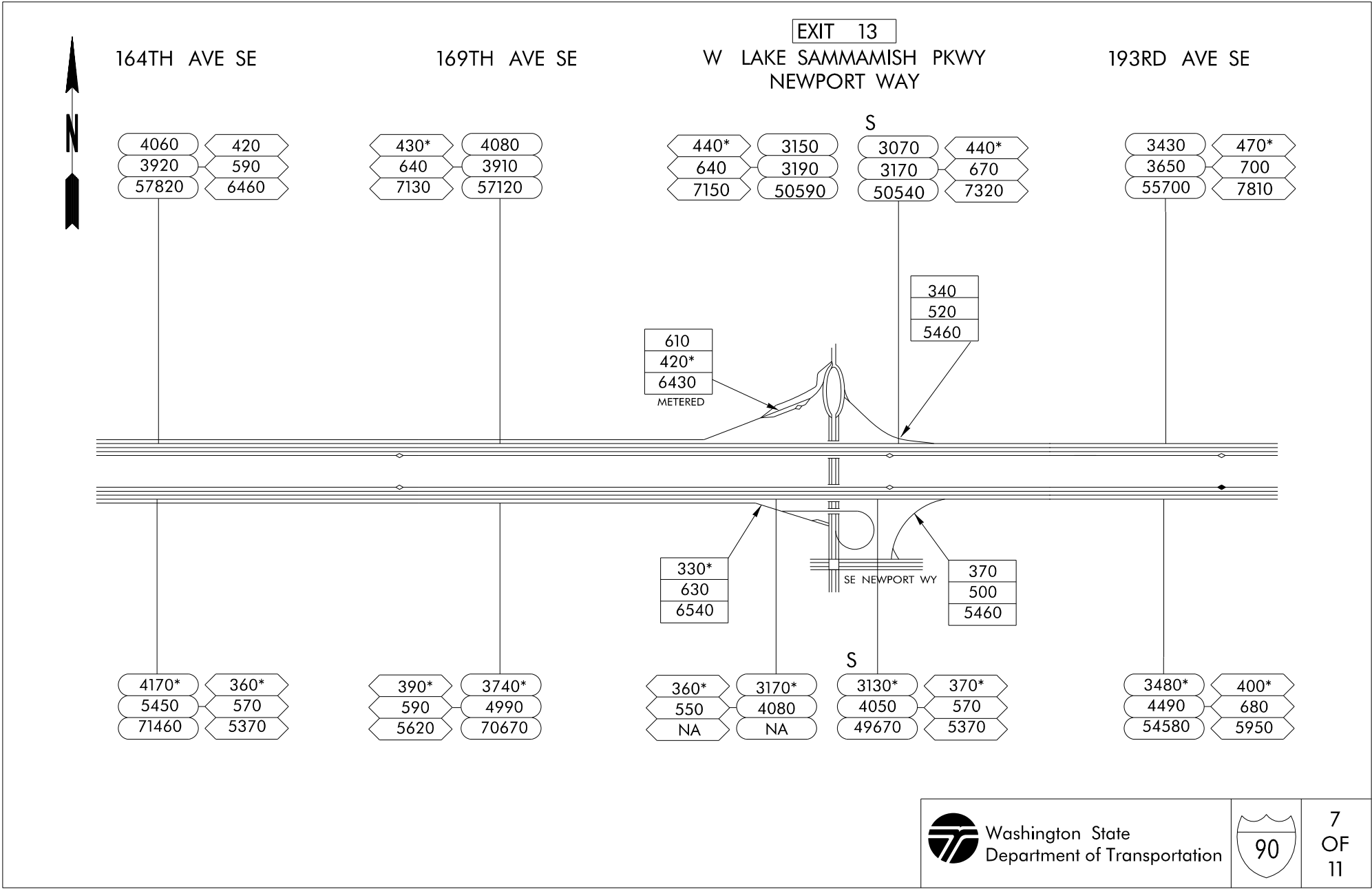



200TH AVE SE

EXIT 15
SR 900
RENTON-
ISSAQUAH RD SE

12TH AVE NW

EXIT 17
FRONT ST
& E LAKE SAMM

EXIT 18
E SUNSET WY
& HIGHLANDS DR NE

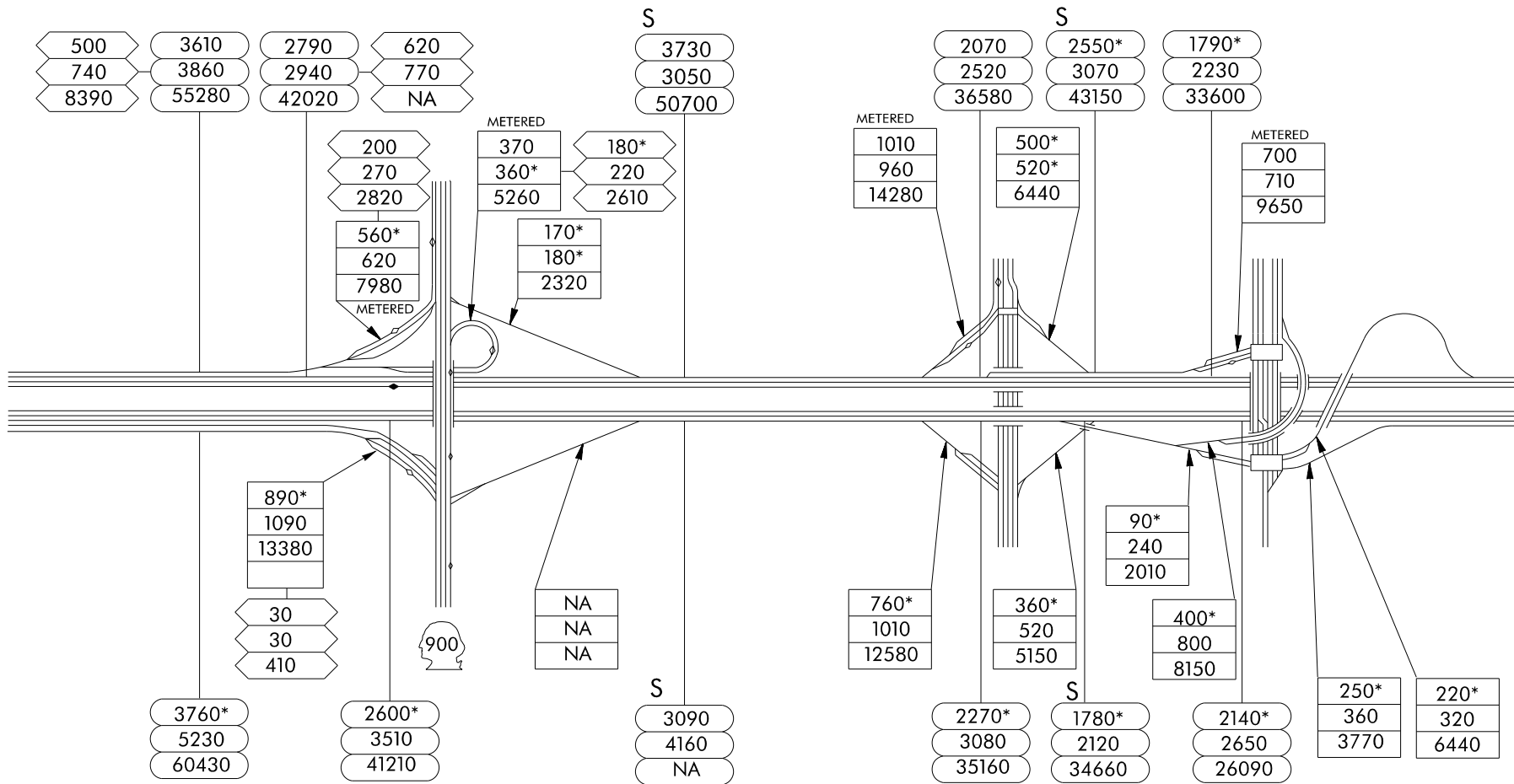

	Washington State Department of Transportation		8 OF 11
--	--------------------------------------------------	--	---------------



246TH AVE SE

256TH AVE SE

EXIT 20
HIGH POINT WAY
270TH AVE SE

S
2000*
2530
33810

S
2030*
2570
33830

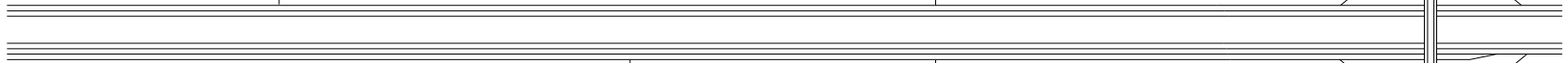

S
2390*
3000
26480

S
2410*
2990
26860

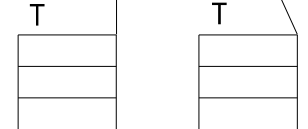

Washington State
Department of Transportation



9
OF
11

EXIT 22
PRESTON-
FALL CITY RD

EXIT 25
SR 18

EXIT 27
SE NORTH BEND WAY

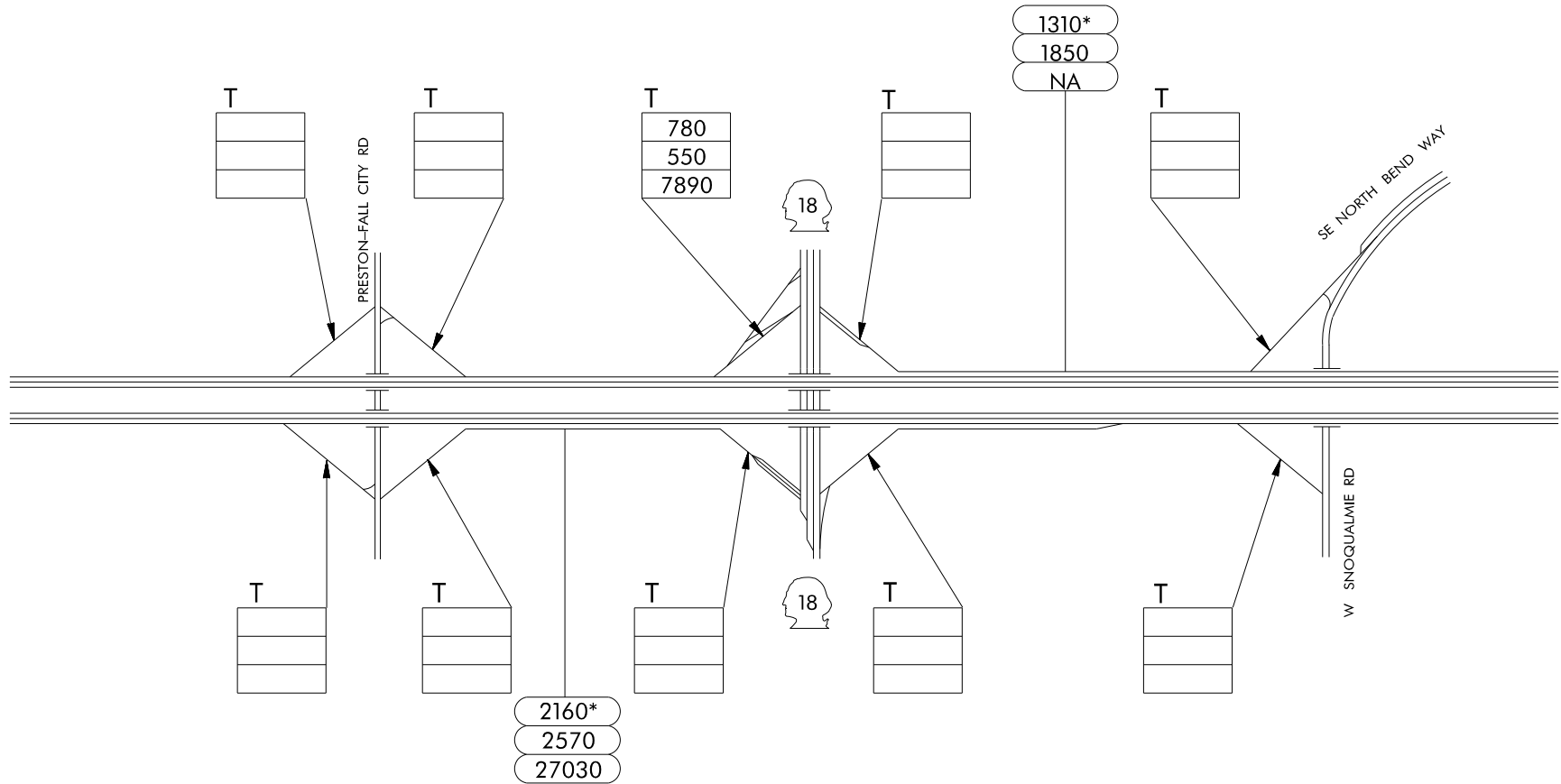

EXIT 31
SR 202

EXIT 32
436TH AVE SE

EXIT 34
EDGEWICK ROAD

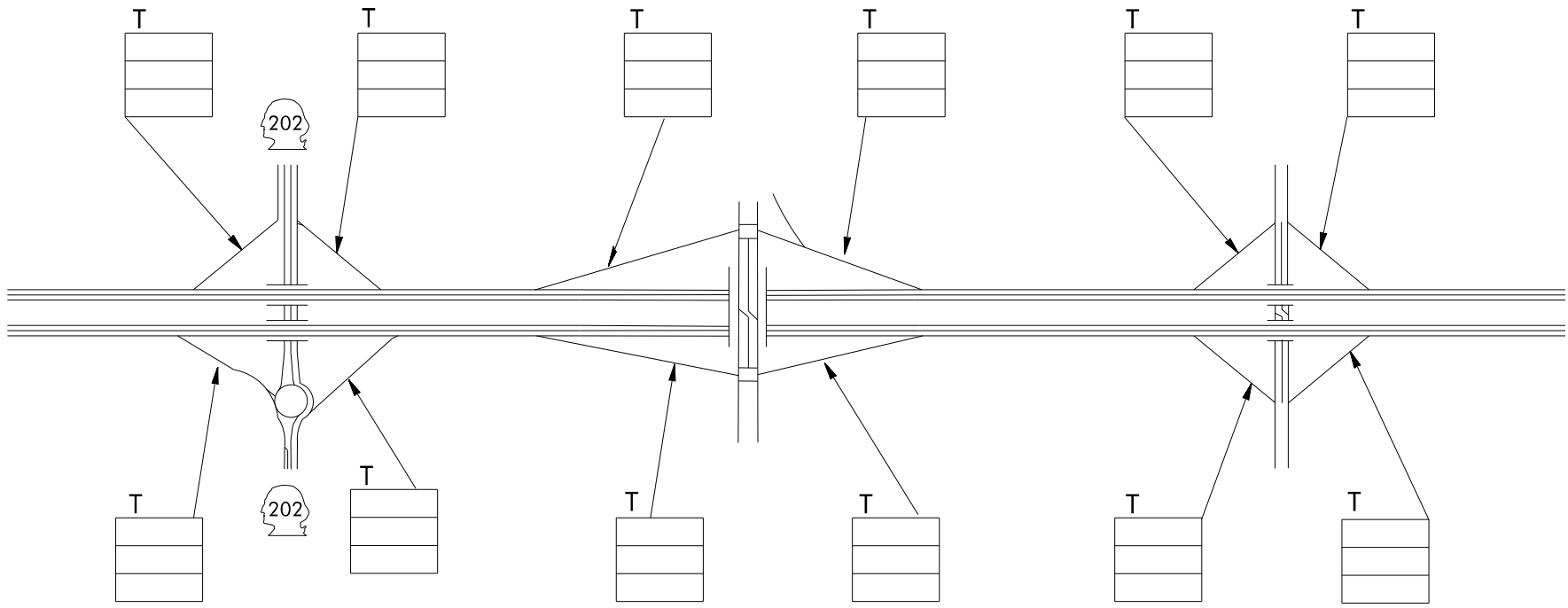

 Washington State Department of Transportation		11 OF 11
----------------------------------------------------------------------------------------------------------------------------------------	---------------------------------------------------------------------------------------	----------------



I-5
(TUKWILA)

ANDOVER PARK W

INTERURBAN AVE S

EXIT 1
SR 181
WEST VALLEY HWY

LONGACRES DR SW

2720	360	4290*
2960	400	4460*
53970	4780	80580

3890	530
3990*	700
72420	8420

4240*	620
4360*	760
77970	10220

540*	40*
780	70
9410	660



1420	380*
1230*	400*
22780	5100

940
950
15810

340
220
3250

METERED

290*
350
4770

500*
520
7130

SOUTHCENTER BLVD

518

1250*
1500
23190



1620*	1260*
1730*	1430*
29960	NA

450*
740
8560

740
780
11320

METERED

320*
480
5580



390*
650
8280

4270*	520*
4670*	950
78410	10920

3850*	610*
4210*	1210
73280	13170

S

4150*	590*
4600	1160
79210	12670



Washington State
Department of Transportation



1
OF
16

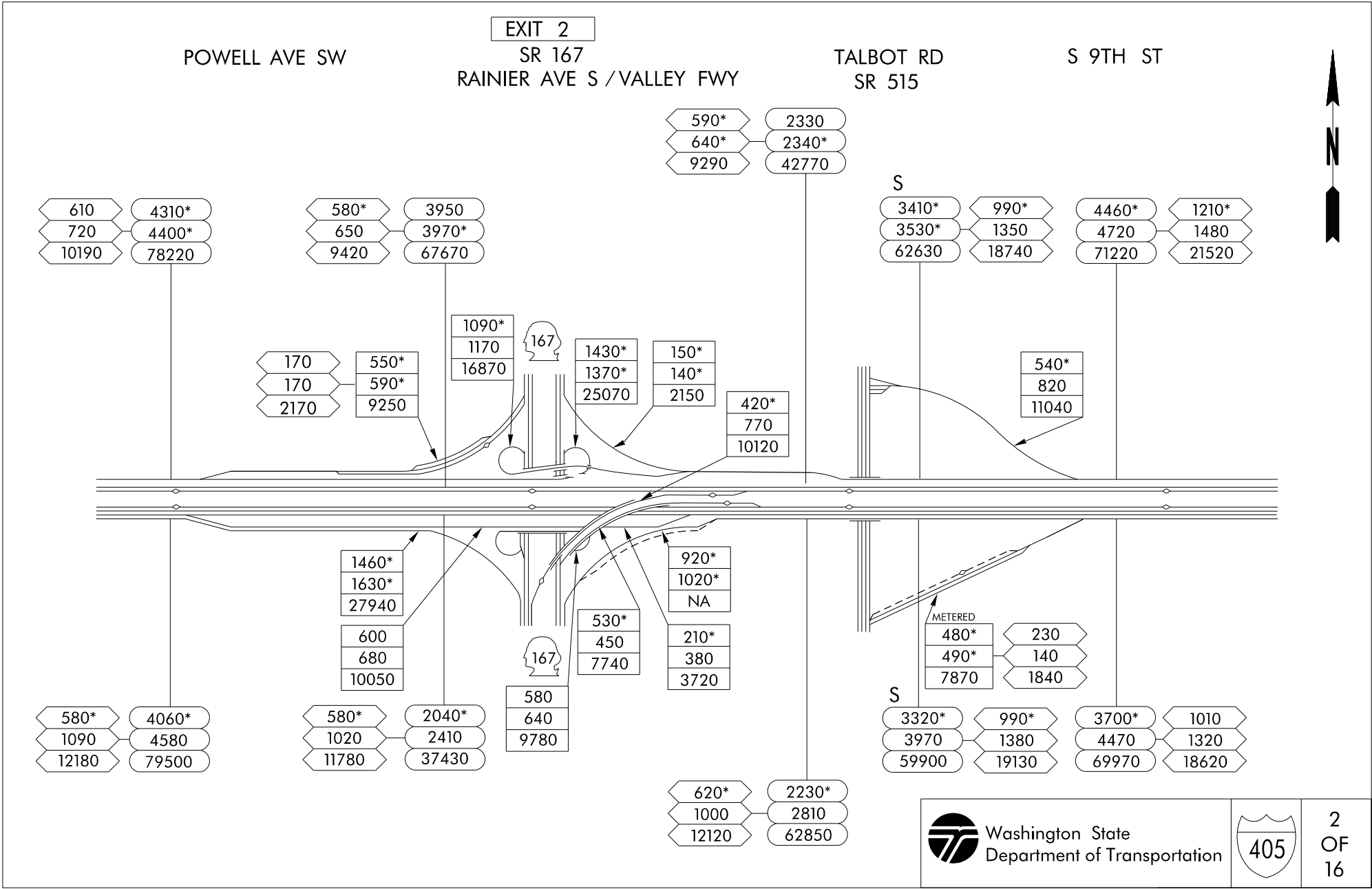

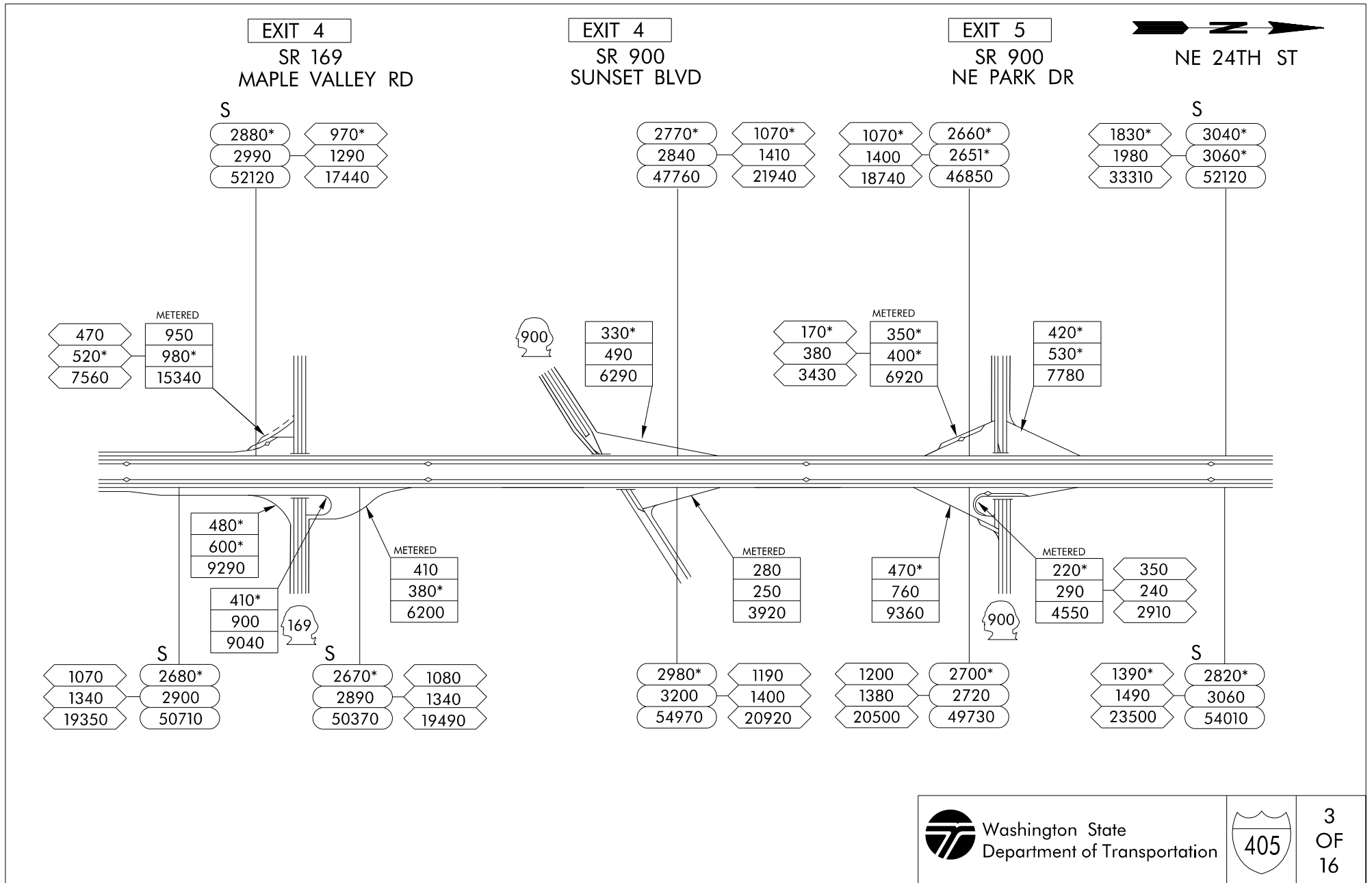

EXIT 6

NE 30TH ST

EXIT 7

NE 44TH ST

SE 72ND ST

SE 64TH ST



NE 37TH ST
KENNYDALE HILL

2890*	1190*
2910*	1490
49530	20890

S	3460*	1250*
	3520	1590
	51270	22150

2850*	1140*
2820*	1490
48090	20190

S	2850*	1360*
	2850*	1560
	46960	24240

S	3190*	790*
	3190*	1060
	56960	14140

METERED

150
160
2390

150*
220
3000

100*
190
1890

METERED

180
190
2770

180*
210
2960

90*
140
1820

METERED

360
210*
3830

20
10
170

NA
NA
NA

METERED

340
200*
3330

2930*	1310
3070	1450
53570	21990

S	3100*	1100
	3290	1170
	59480	18630

2840*	1240
2810*	1130
48120	19980

S	3480*	500
	3440*	470*
	62910	NA

S	3030*	1400
	3100	1420
	47710	23800

	Washington State Department of Transportation		4 OF 16

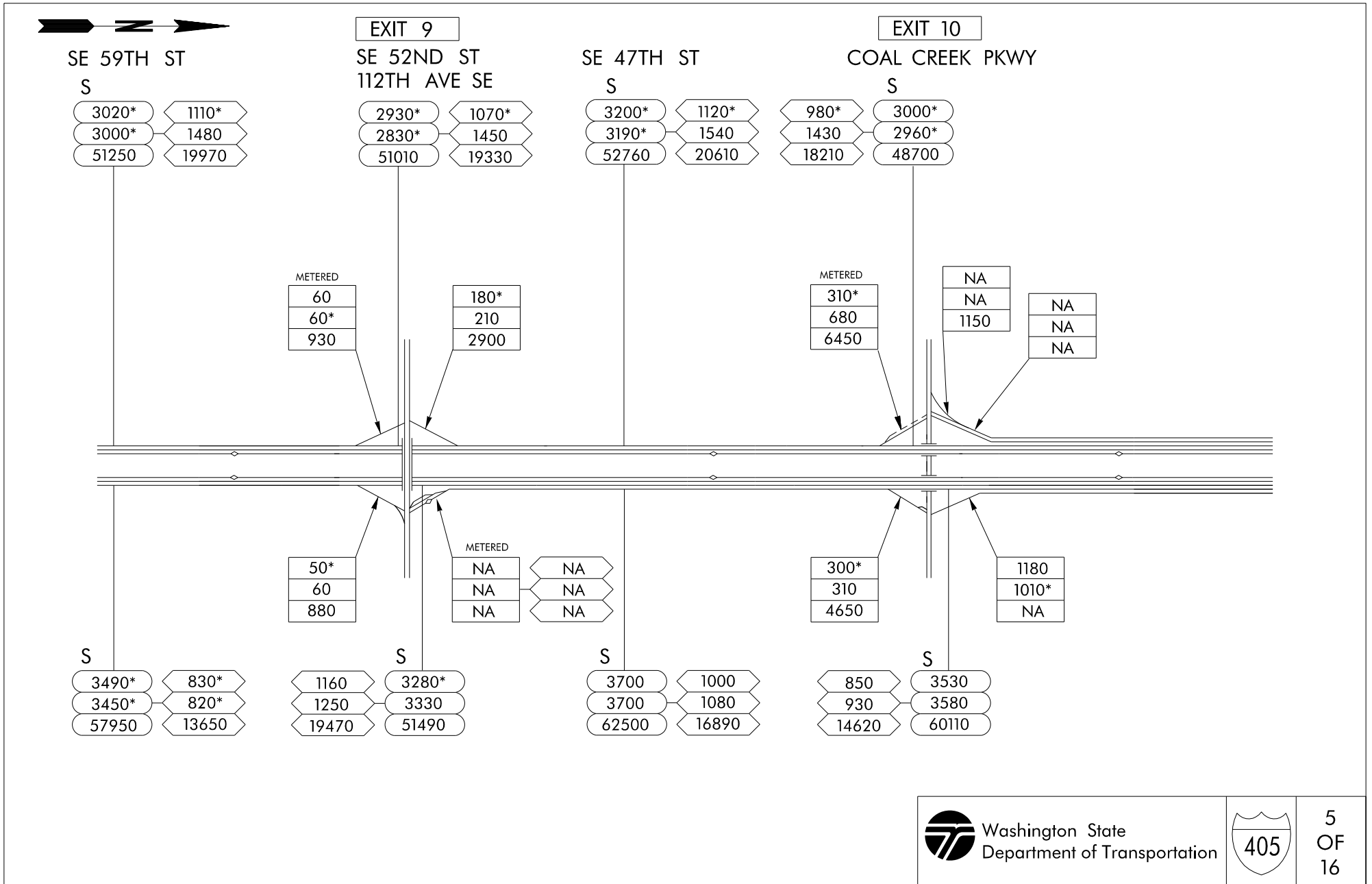



SE 39TH ST

EXIT 11

I-90

SE 24TH ST

SE 17TH ST

S

2400*	740*
2400*	1170
NA	NA

2400*	720*
2450*	1150
37450	13550

S

4870*	260*	730*	5180*	190*	730*
5060*	590	1120	5390*	670	1090
77210	5160	13100	80920	4820	12690

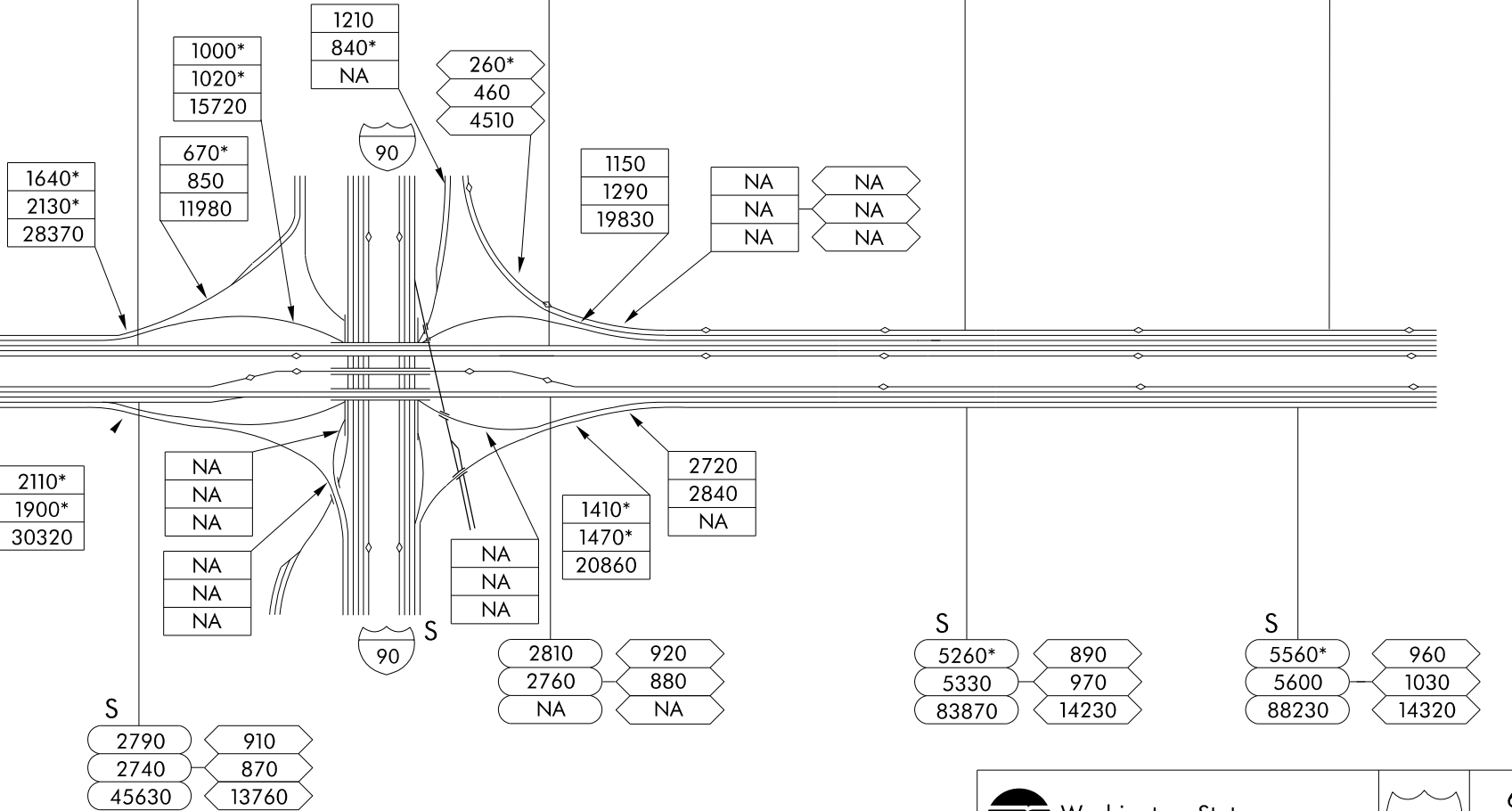

	Washington State		6
	Department of Transportation		
			16

EXIT 12

SE 8TH ST

MAIN ST

S

4900*	750*
5150*	1080
74940	12750

METERED

190*	40*
330	220
3070	1300

590
600
7350

190	550
170	390*
2850	5450

116th Ave SE

METERED

410*	170
560	190
6460	2310

S

5640*	850
5840	990
82350	12330

S

4120*	630*
4320	850
74330	10760



	Washington State Department of Transportation		7 OF 16

EXIT 13A
NE 4TH ST

HOV ONLY EXIT
NE 6TH ST

EXIT 13B
NE 8TH ST

NE 10TH ST

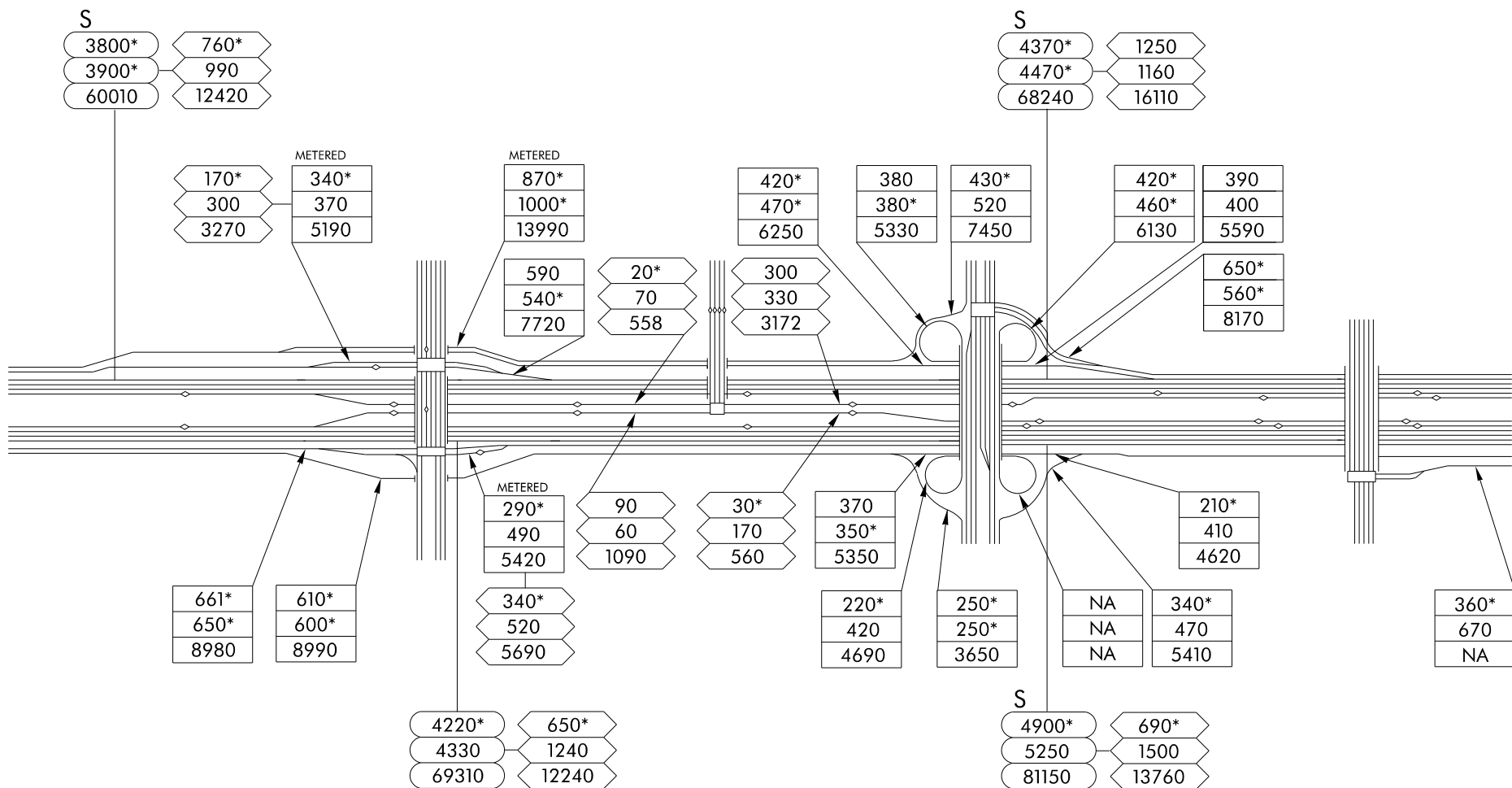

	Washington State Department of Transportation		8 OF 16
--	--------------------------------------------------	--	---------------

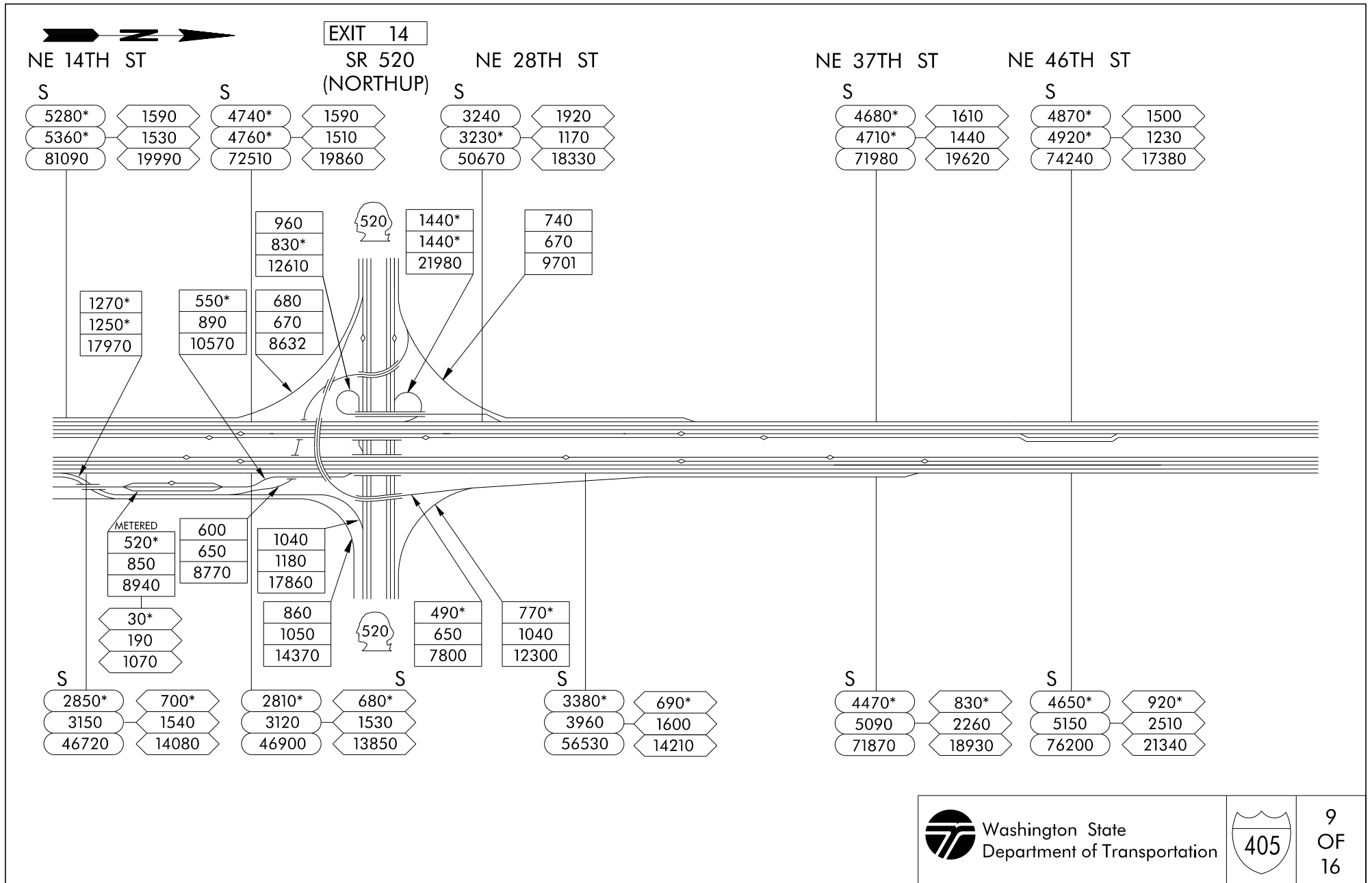

NE 57TH ST

EXIT 17
NE 70TH PL

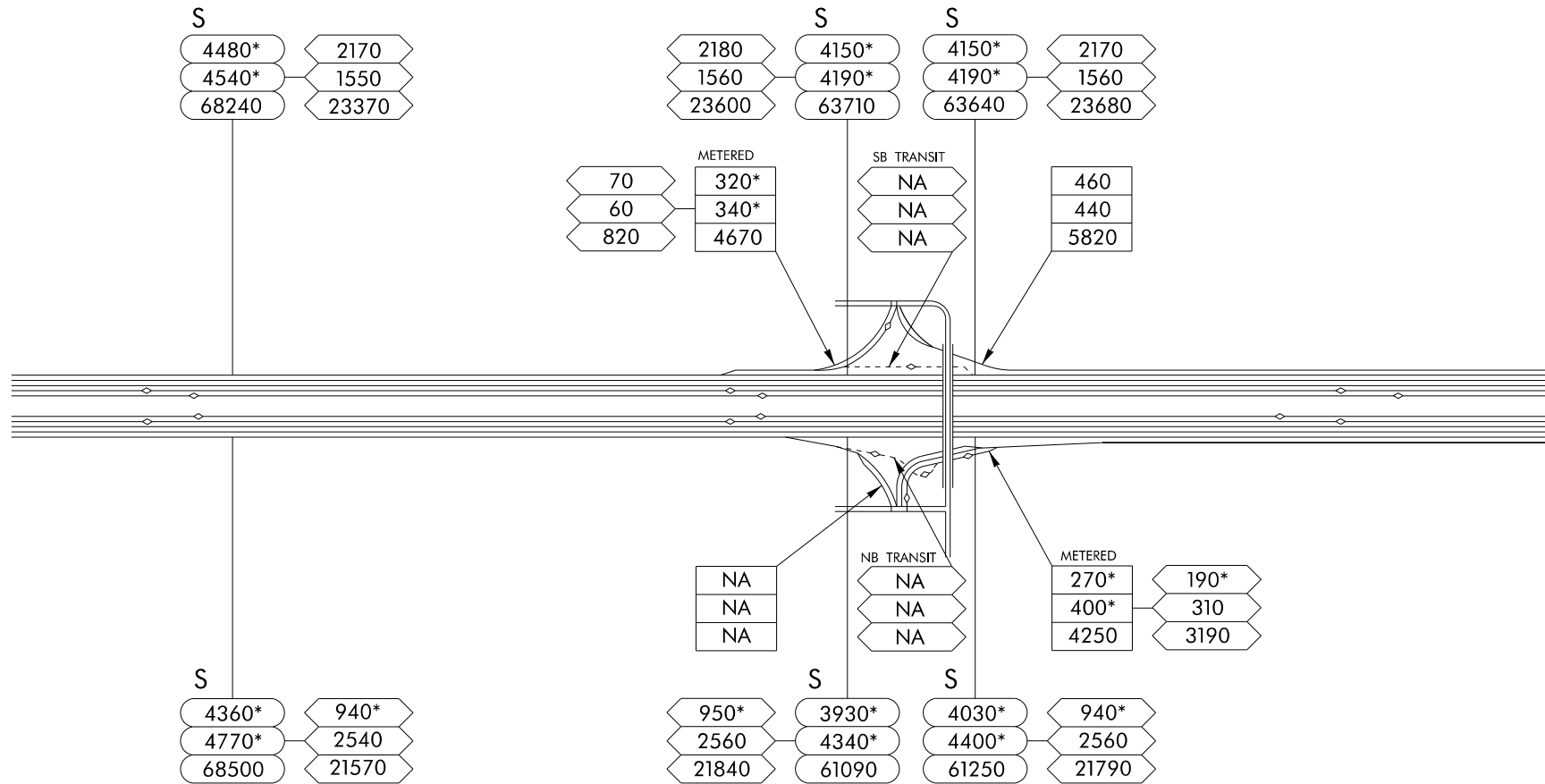

	Washington State Department of Transportation		10 OF 16
--	--------------------------------------------------	--	----------------



EXIT 18
NE 85TH ST

NE 97TH ST

NE 106TH ST

S

3759*	2160
3770*	1550
56740	23490

10*
20
210

520
530
7990

350*
390
5260

METERED

380*
420
5440

METERED
380*
400*
5010

390*
420*
5190

510
520
7960

S

3740*	2160
3750*	1550
56550	23560

S

4990*	2330
5000*	1650
70860	25110

S

3970*	2220
3960*	1470
72690	22920

340
360*
5160

METERED
360*
430
5420

290
290*
4050

380*
460
5800

METERED
410*
430*
6160

350
360*
5020

S

3700*	950*
4100*	2600
59200	22060

70*
170
1520

S

3700*	930*
4090*	2590
59430	21810

4840*	1020*
5350*	2890
70860	24190

S

4470*	940*
4940	2530
72900	22070



Washington State
Department of Transportation



11
OF
16

EXIT 20A
NE 116TH ST

EXIT 20\20B
NE 124TH ST
TOTEM LAKE BLVD

NE 128TH ST

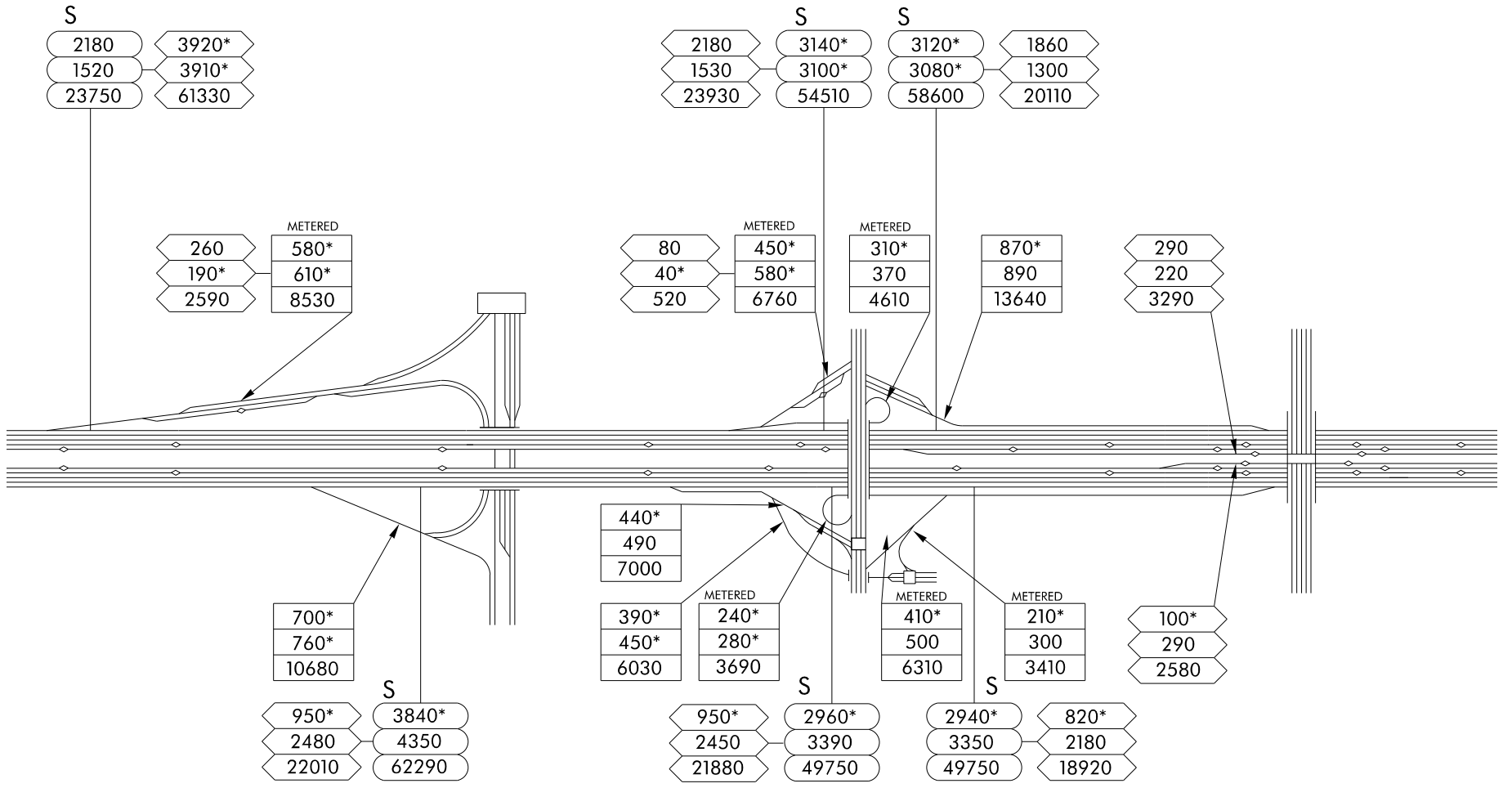

 Washington State Department of Transportation		12 OF 16
----------------------------------------------------------------------------------------------------------------------------------------	---------------------------------------------------------------------------------------	----------------



NE 132ND ST NE 140TH ST NE 144TH ST

EXIT 22
NE 160TH ST
JUANITA-WOODINVILLE WY NE

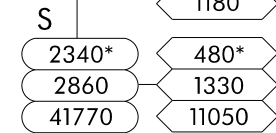
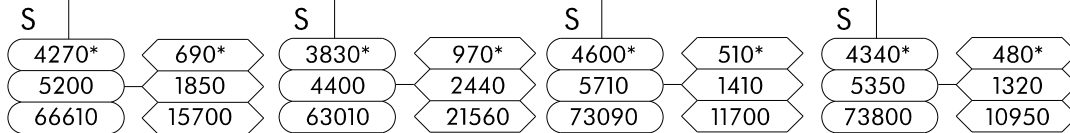
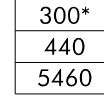
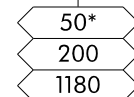
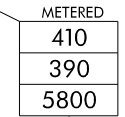
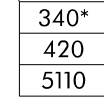
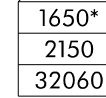
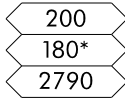
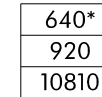
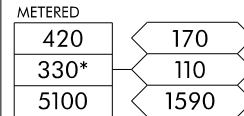
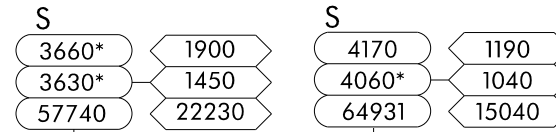
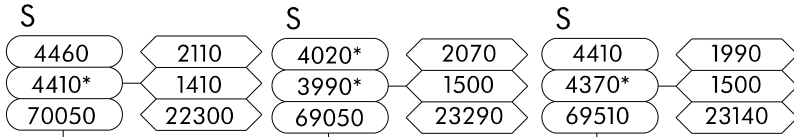

Washington State
Department of Transportation



13
OF
16

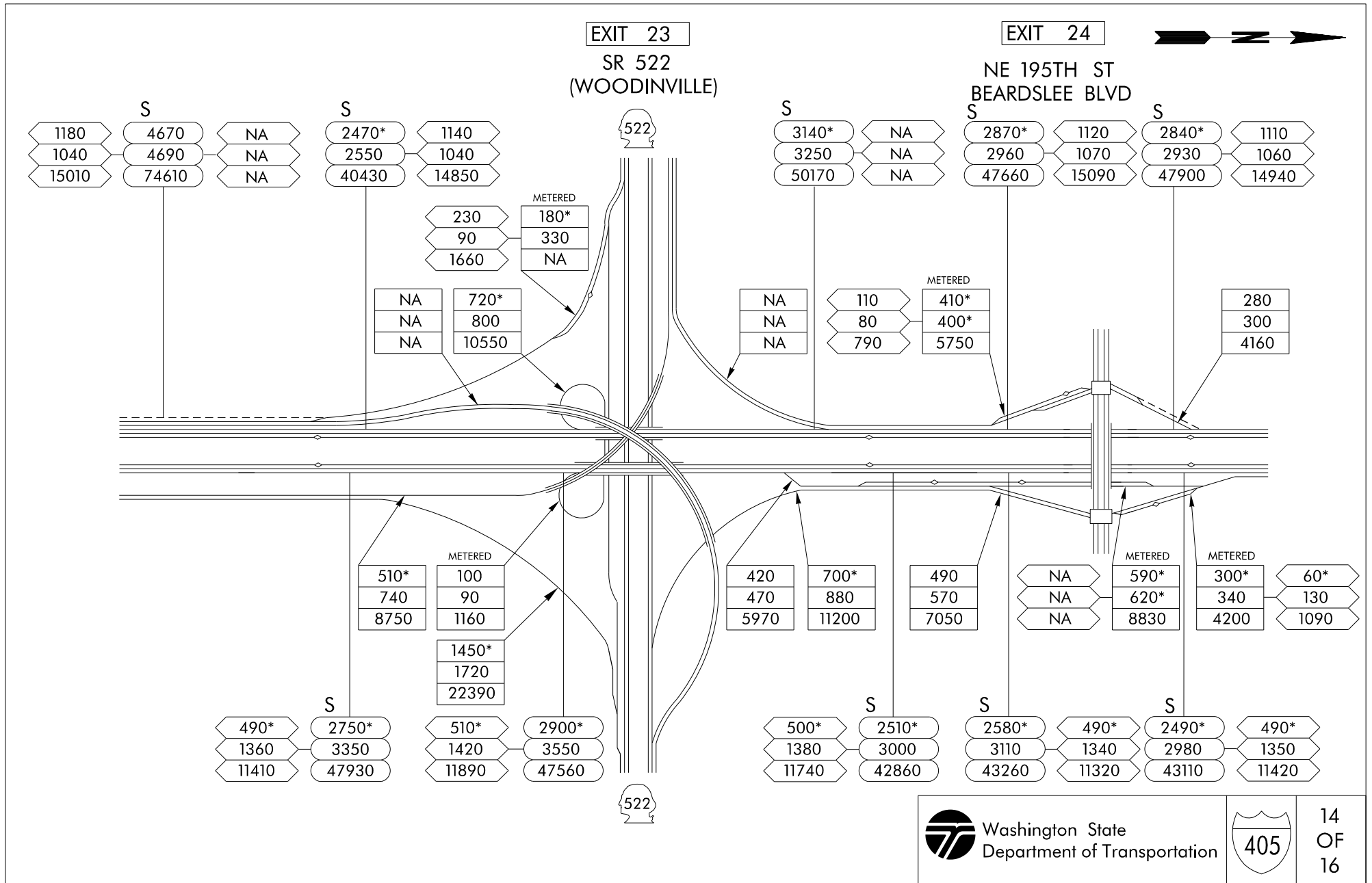

	Washington State Department of Transportation		14 OF 16

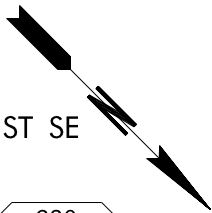

EXIT 26

SR 527

242ND ST SE

236TH ST SE

230TH ST SE

BOTHELL - EVERETT HWY

216TH ST SE

S

3360*
3470
49120

1300
1260
18000

S

3140*
3230
51860

1090
1060
15020

S

3180*
3250
52470

1060
1040
14490

S

2240*
2350
36410

920
890
12230

S

2250*
2360
36480

910
870
12020

S

2980*
3260
26930

930
870
12080

METERED

520*
510*
7420

7
4
60

METERED

460*
440*
6800

290
290*
4130

220
280
4100

METERED

350
360
5490

170*
180
2530

METERED

250
350
4320

40*
70*
560

S

4340*
5250
69900

500*
1390
11680

S

3450*
4320
69920

520*
1250
11030

S

3440*
4300
69330

520*
1240
11020

S

2410*
2810
39200

520*
1230
10990

S

2410*
2810
39040

530*
1240
11160

S

3110*
3250*
51740

540*
1240
11180



Washington State Department of Transportation



15 OF 16

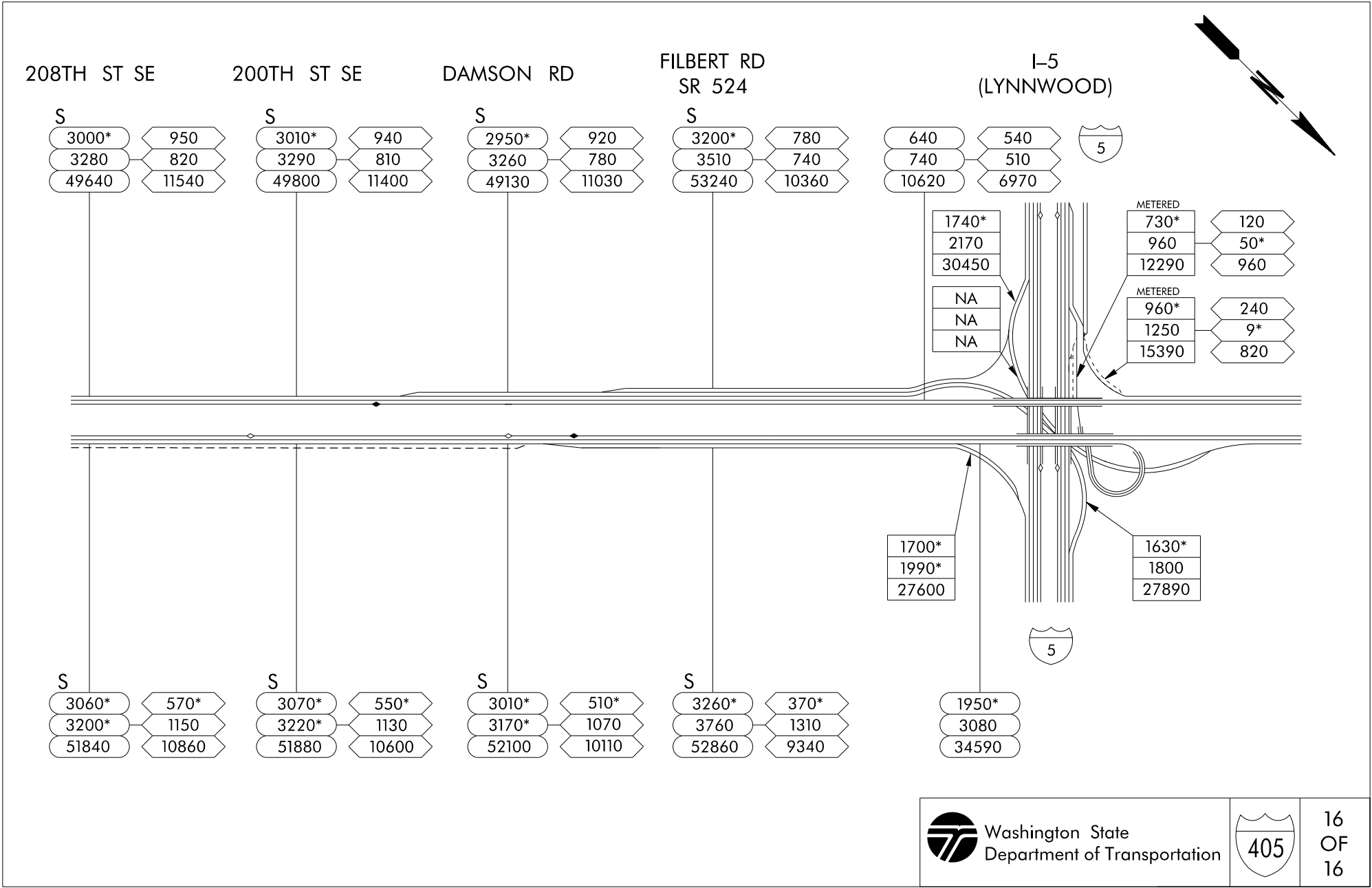



WEST VALLEY SR 167
HWY

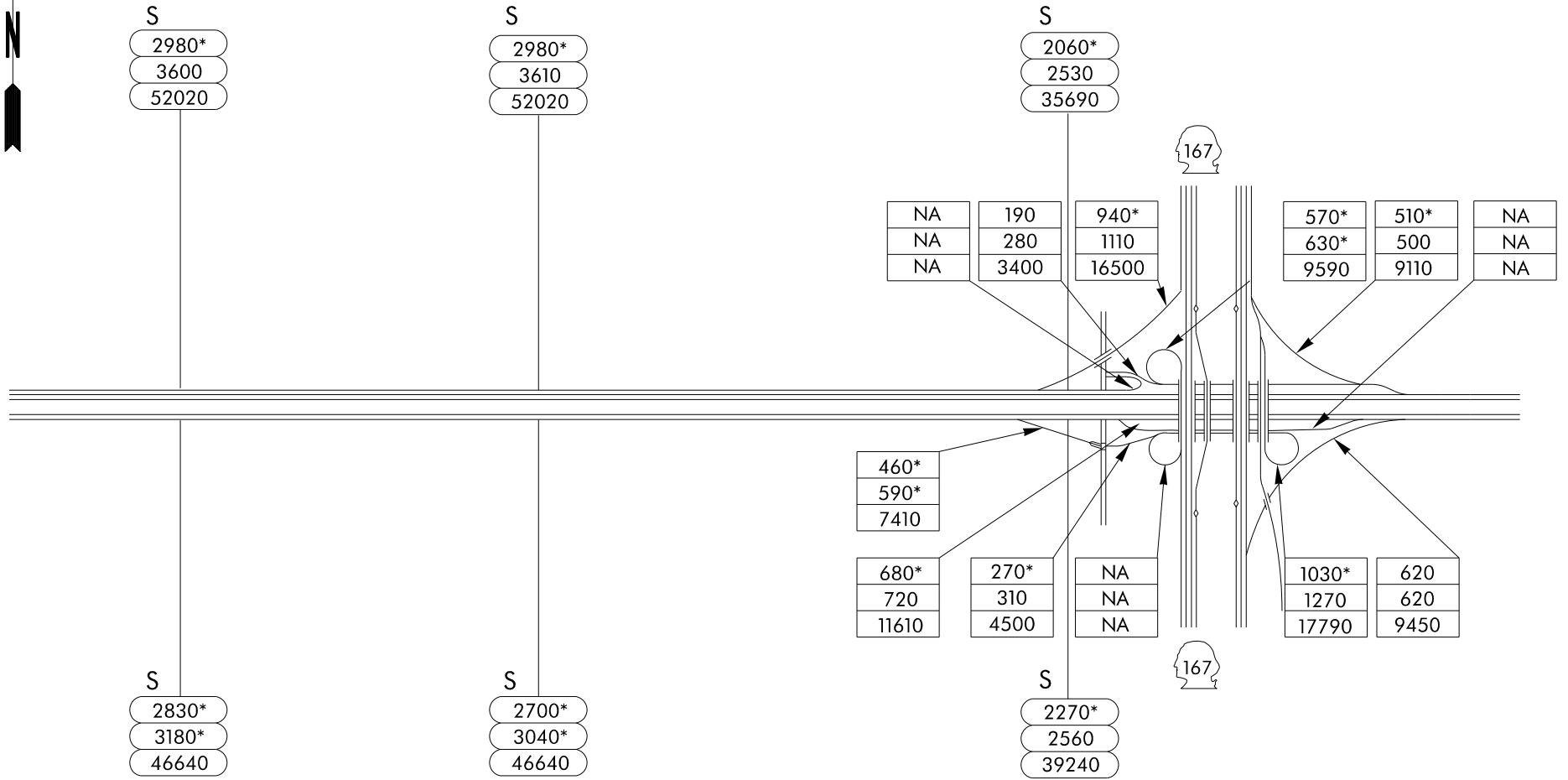

Washington State
Department of Transportation



2
OF
7

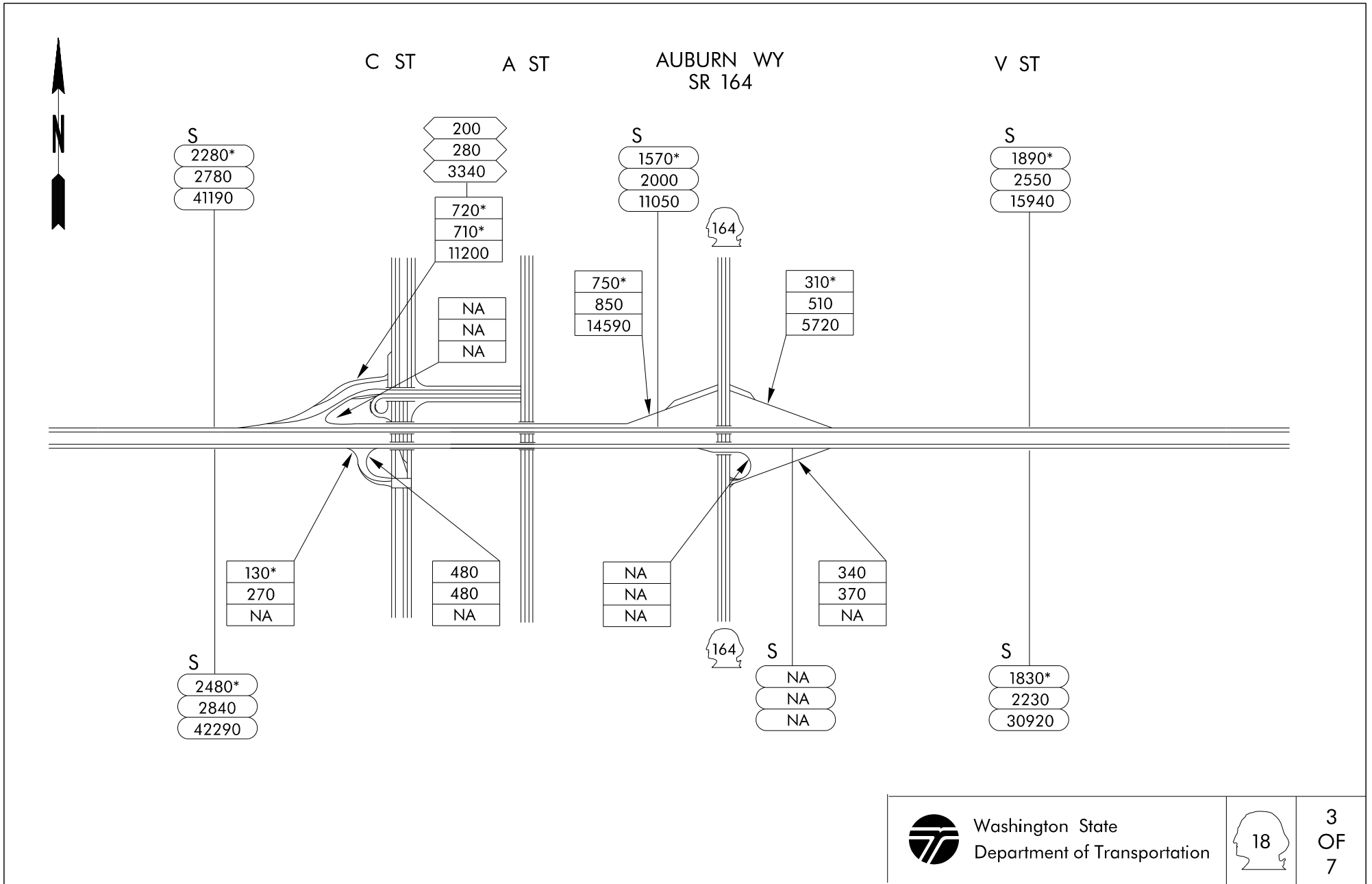

AUBURN-
BLACK DIAMOND RD

SE 304TH ST

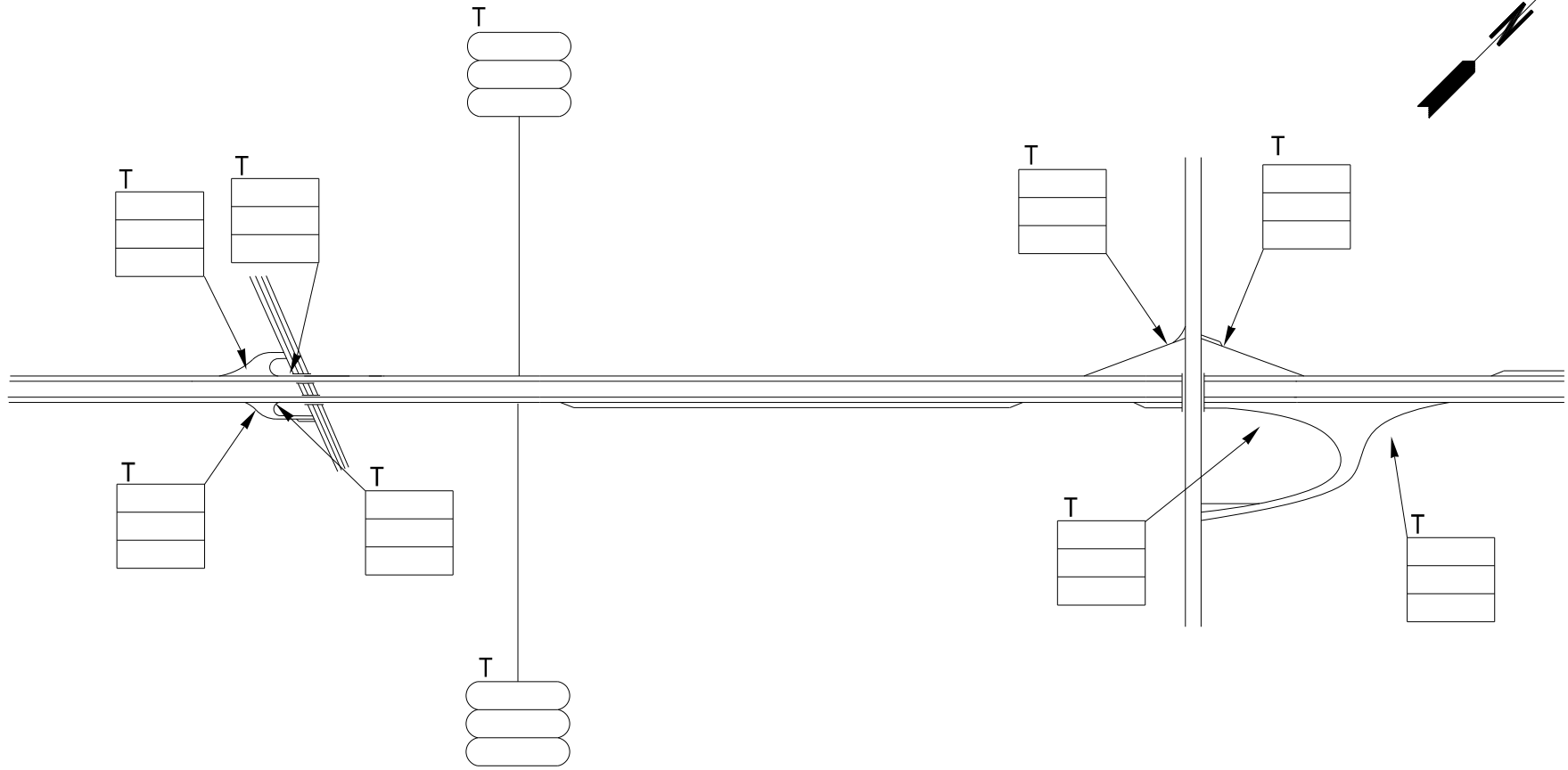

Washington State
Department of Transportation



18

4
OF
7

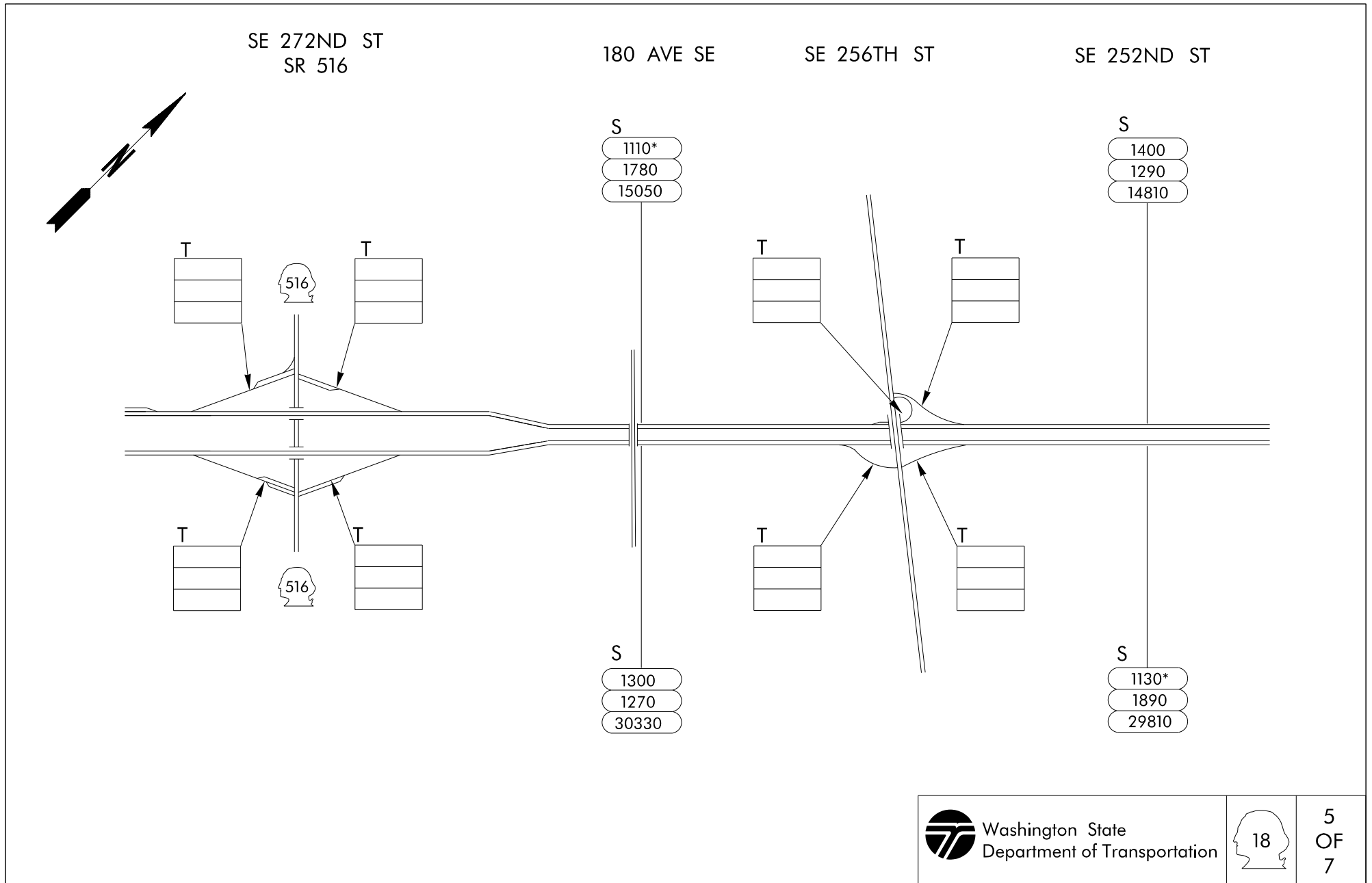

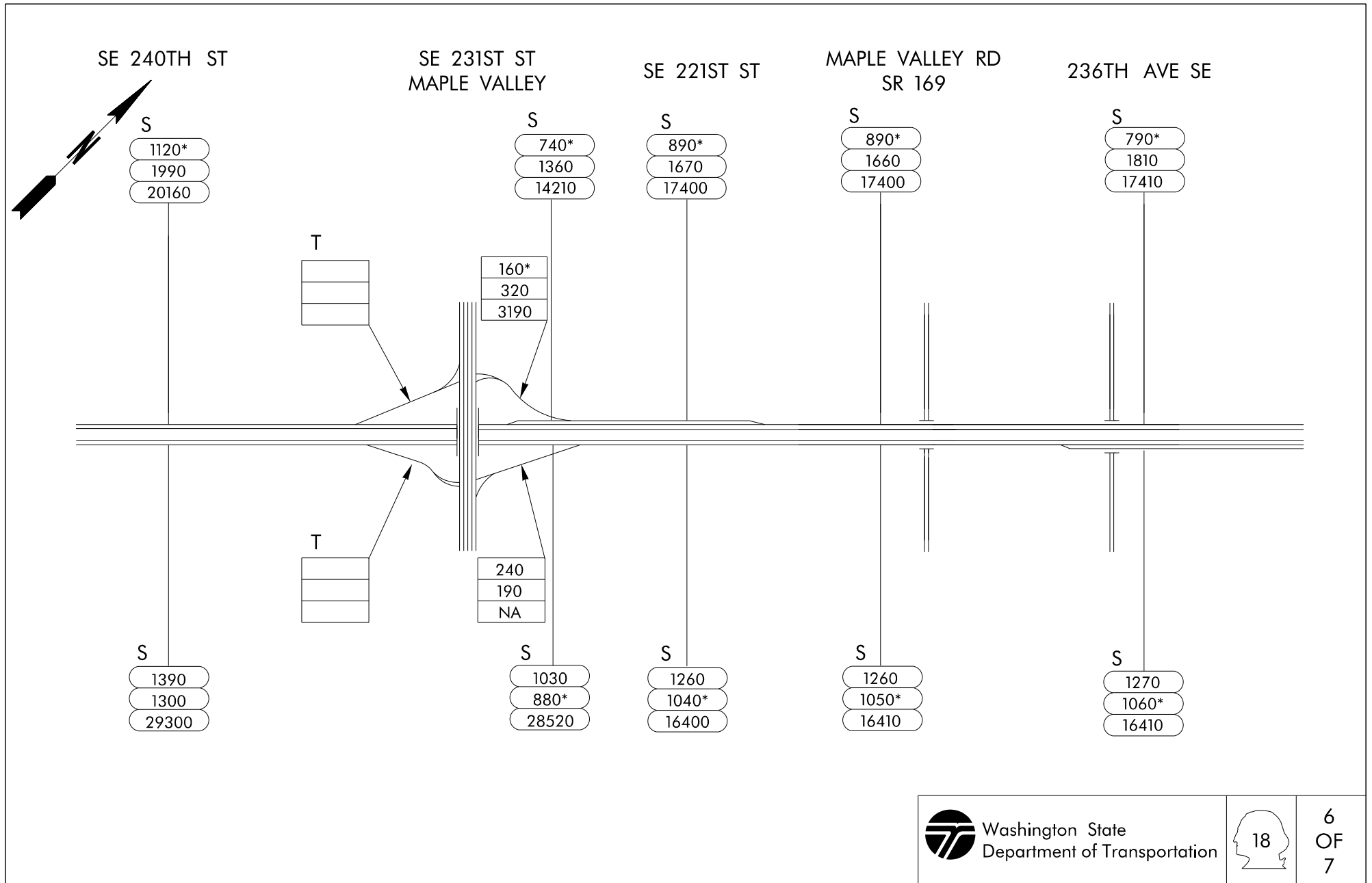

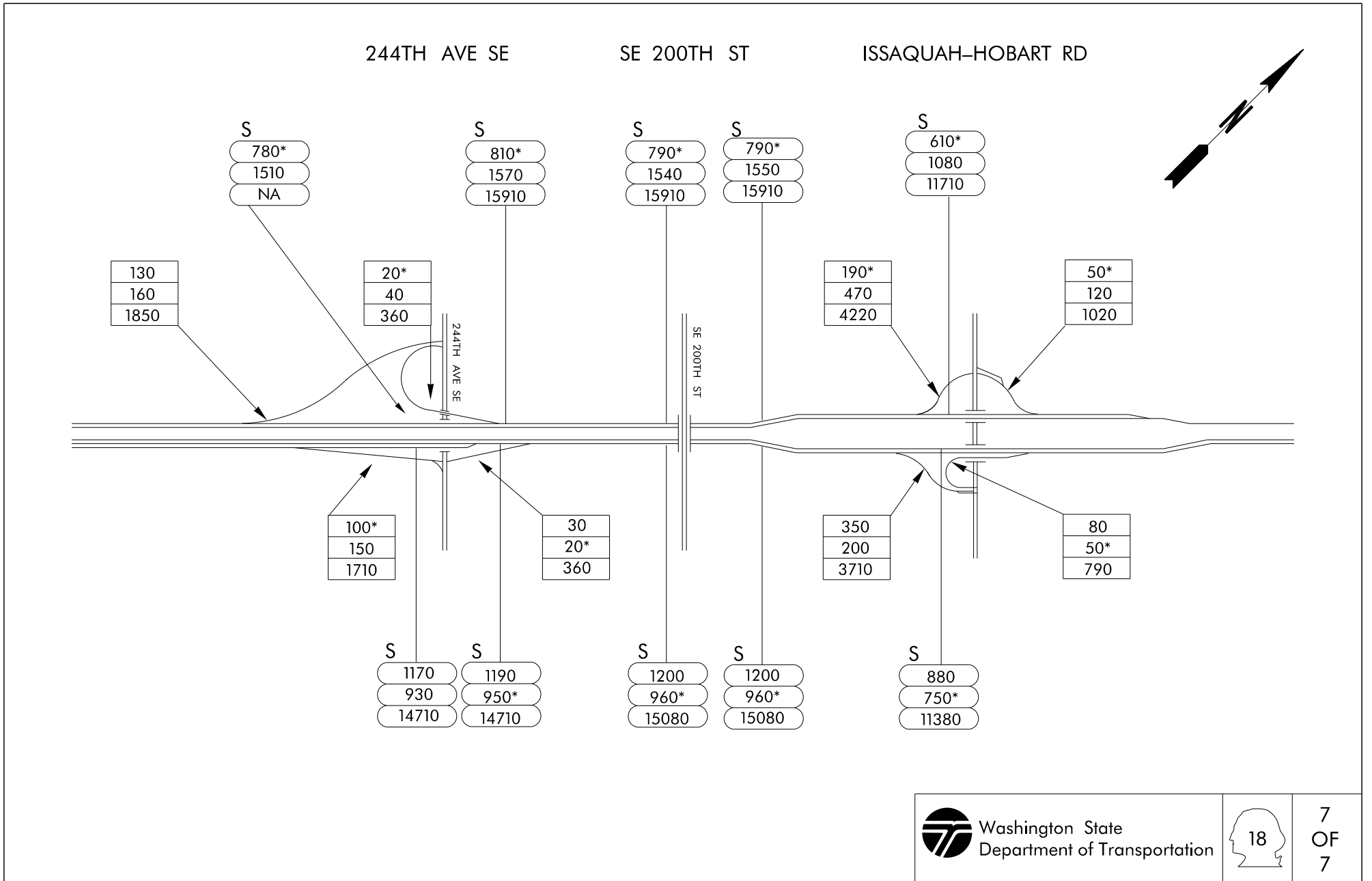

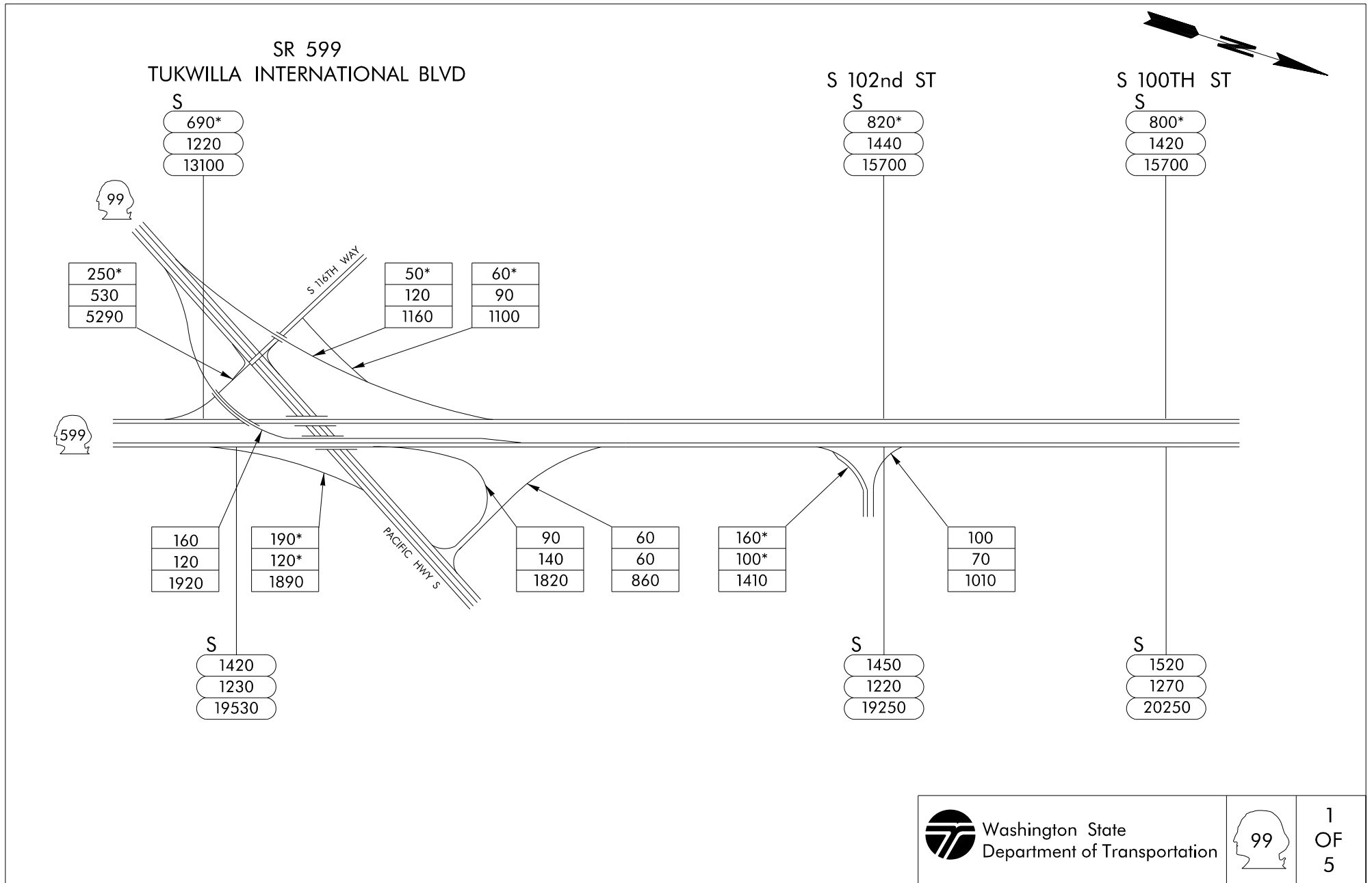



DES MOINES MEMORIAL DR
14TH AVE S

S CLOVERDALE ST

S KENYON ST

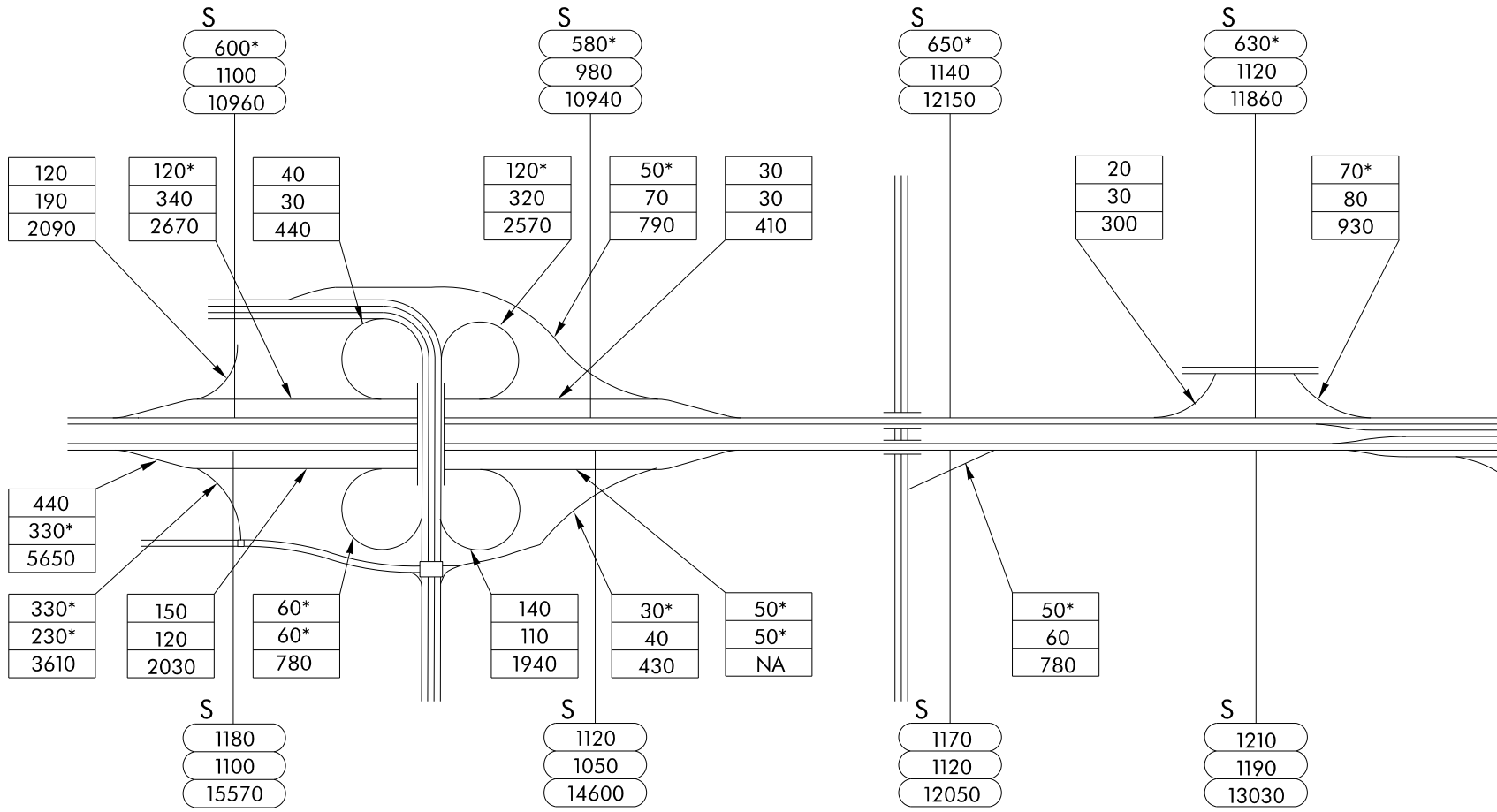

SR 509
S HOLDEN ST



1ST AVE BRIDGE S

1160*	160*
2570	700
25560	4690

190
290
3240

400*
660
7150

310*
420
5530

960*
970
13890

2010	550
1470	150
25990	3400



Washington State
Department of Transportation



3
OF
5



S LANDER ST

ROYAL BROUGHAM

ER 2

ER 6

S
1190*
2910
20210

500*
1140
19820

S
690*
1700
20230

S
1170
2350
20480

S
1170
2350
20370

SR 99 Tunnel

20
30
350

480
620
6210

S
2470
2110
22850

S
1600
1400
18800

S
1960
1930
24950

S
1940
1930
24890



Washington State
Department of Transportation



4
OF
5



ER 10

S
1160
2350
20240

ER 14

S
1170
2370
20120

MERCER ST

S
1050
1940
15660

COMSTOCK ST

S
1720
2440
27920

SR 99 Tunnel

870
920
12440

200*
510
4320

630
430
6090

460*
950
9210

S
1920
1930
24830

S
1910
1930
24770

S
1350
1510
18640

S
1670
2690
27900



Washington State
Department of Transportation



5
OF
5



ELLINGSON RD

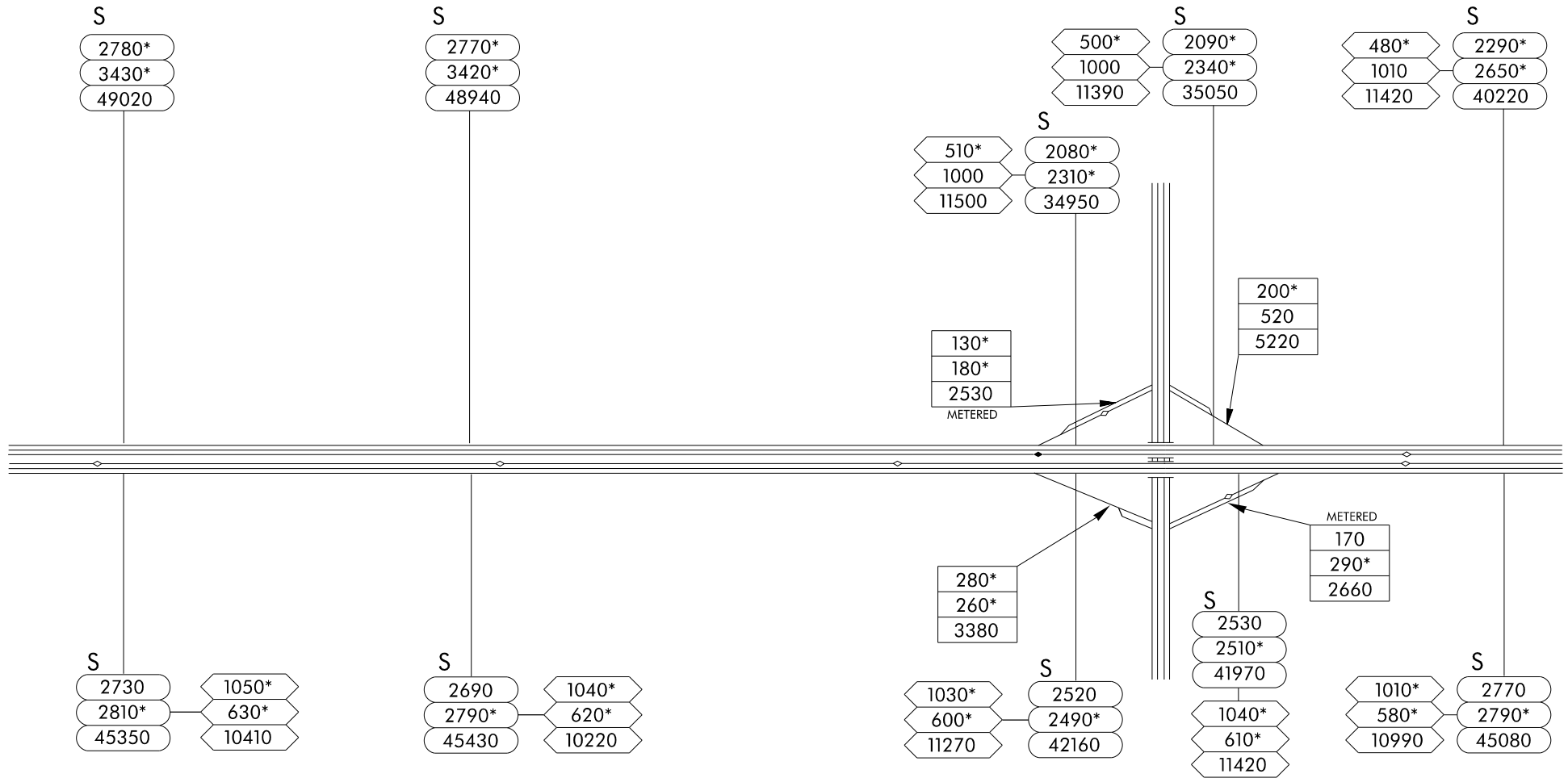

	Washington State Department of Transportation		1 OF 6
--	--------------------------------------------------	--	--------------

7TH AVE N

15TH ST SW

SR 18

S

S

15TH ST NW

S

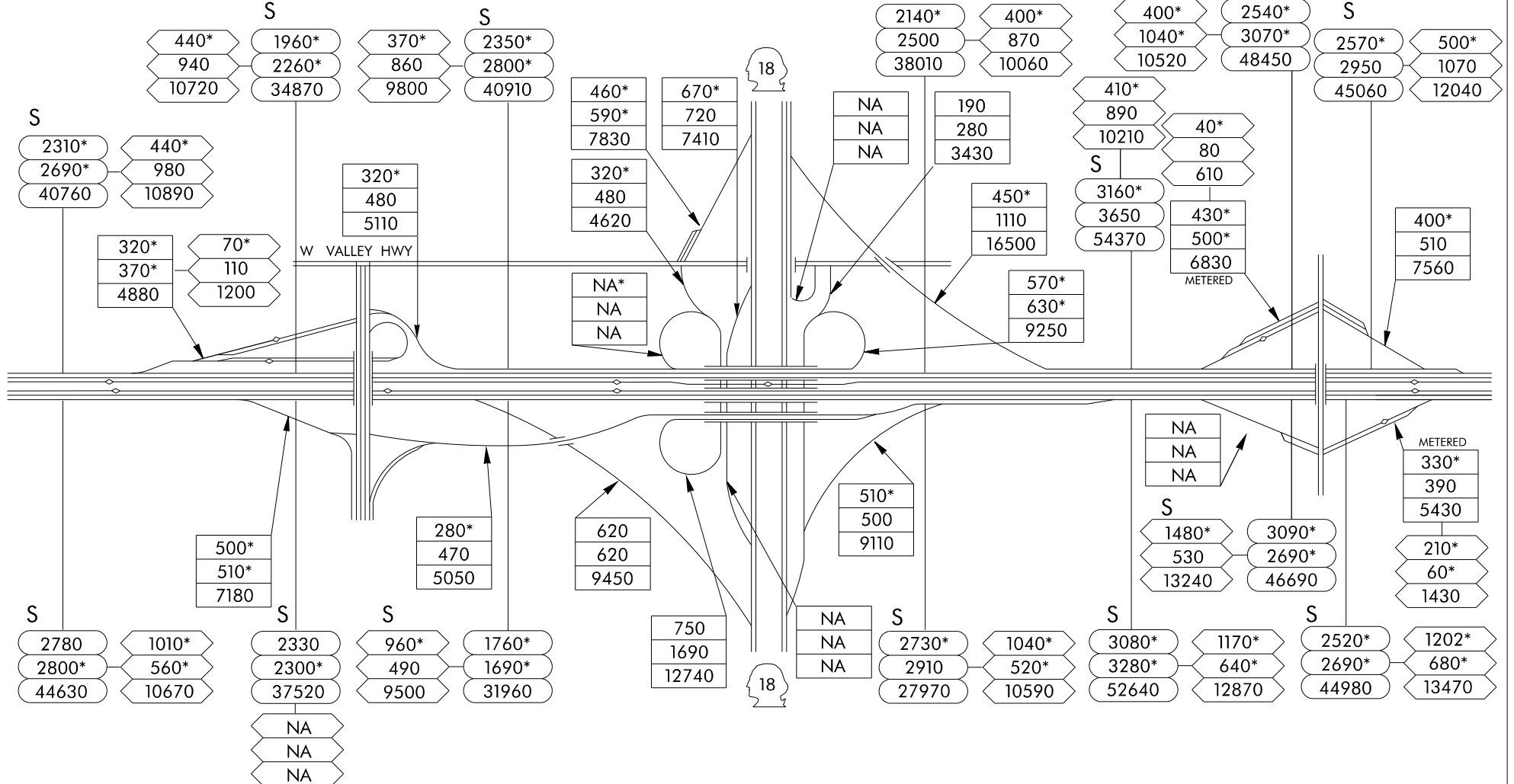



EMERALD
DOWNS

34TH ST NW

37TH ST NW

S 277TH ST

S 269TH ST

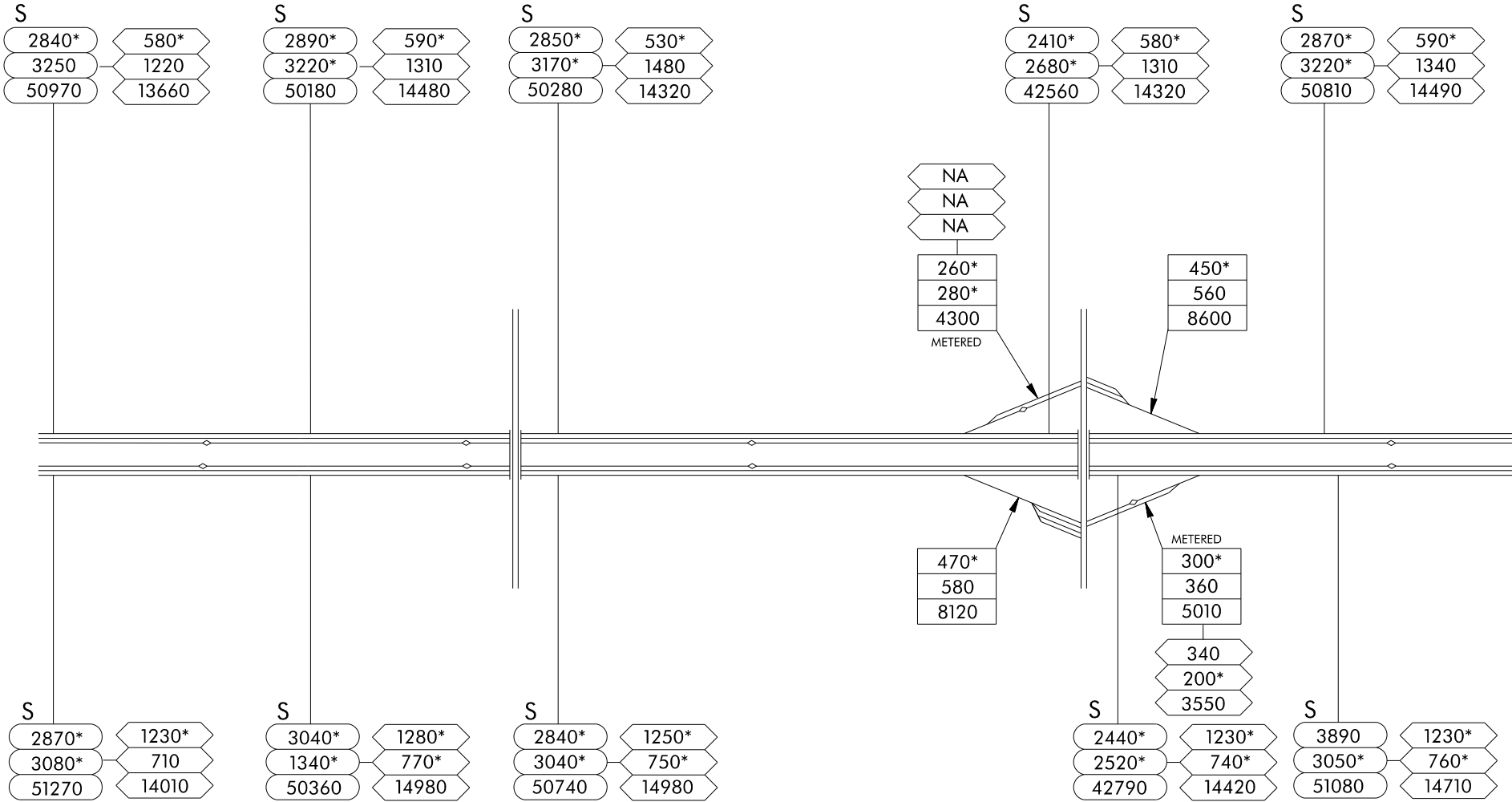

Washington State
Department of Transportation



167

3
OF
6



GREEN RIVER

SR 516 WILLIS ST

JAMES ST

4TH AVE

84TH AVE S CENTRAL AVE

S

2870*	580*
3220*	1380
50670	14630

S

2260*	570*
2550*	1320
40500	14180

S

2610*	610*
2950*	1340
45890	14730

S

2610*	580*
2960*	1370
NA	NA

S

2200*	590*
2470*	1290
39160	14280

110*
310
2670

570*
600*
10050

METERED



340*
400
5900

METERED

430*
520
7190

560*
680
10800

720
810
12930



METERED

200*	200.
250	150*
3560	2490

390
300*
5500

METERED

540*	370
590	170*
9420	2880

S

3870	1220*
3020*	770*
51140	14640

S

2200*	1170*
2280*	740*
38780	14070

S

2520	1160*
2650*	750*
44800	14110

S

2530	1140*
2660*	740*
44940	13980

S

2190	1090*
2320*	720*
39880	13500



Washington State Department of Transportation



4 OF 6



S 222ND ST

S 212TH ST

S 204TH ST

S 194TH ST

S

2780*	550*
3160*	1260
50580	13690

S

2370*	600*
2690*	1190
42380	14670

S

2830*	590*
3210*	1320
52130	14690

S

2890*	640*
3280*	1390
51120	15740

S

2850*	580*
3240*	1360
52050	14760

100*
230
1950
350
320*
5320
METERED

580
570
9800

NA
NA
NA

METERED

440*
520
6800

S

2860*	1100*
3040*	770*
51490	14160

2760*	1500*
2510*	700*
42420	14260

S

3760*	1120*
2890*	820*
48260	15140

S

2820*	1130*
2950*	820*
48560	14340

S

2770*	1100*
2890*	820*
45080	14830



Washington State Department of Transportation



167

5 OF 6

S 180TH ST

SW 41ST ST

S 34TH ST

S 23RD ST



S	2410*	540*
	2760*	1260
	44710	13790

S	3170*	500*
	3510*	1190
	55800	12880

S	3200*	500*
	3590	1120
	56320	12380

110*
280
2220

380*
390
6120
METERED

700*
690*
10150

E VALLEY HWY

350*
810
10180

1460*
1640*
28030

METERED

NA
NA
NA

METERED

380*
410
5890

150*
200*
2560

S	2100*	1060*
	2190*	810*
	37470	14490

S	2610*	NA
	2700*	NA
	45540	NA

S	3200*
	3490*
	57330

530*
450
7710

580	890
640	930
9780	14810

430
780
9680

S	2070*
	2210*
	25690



Washington State Department of Transportation



6 OF 6

S 188TH ST

S 160TH ST

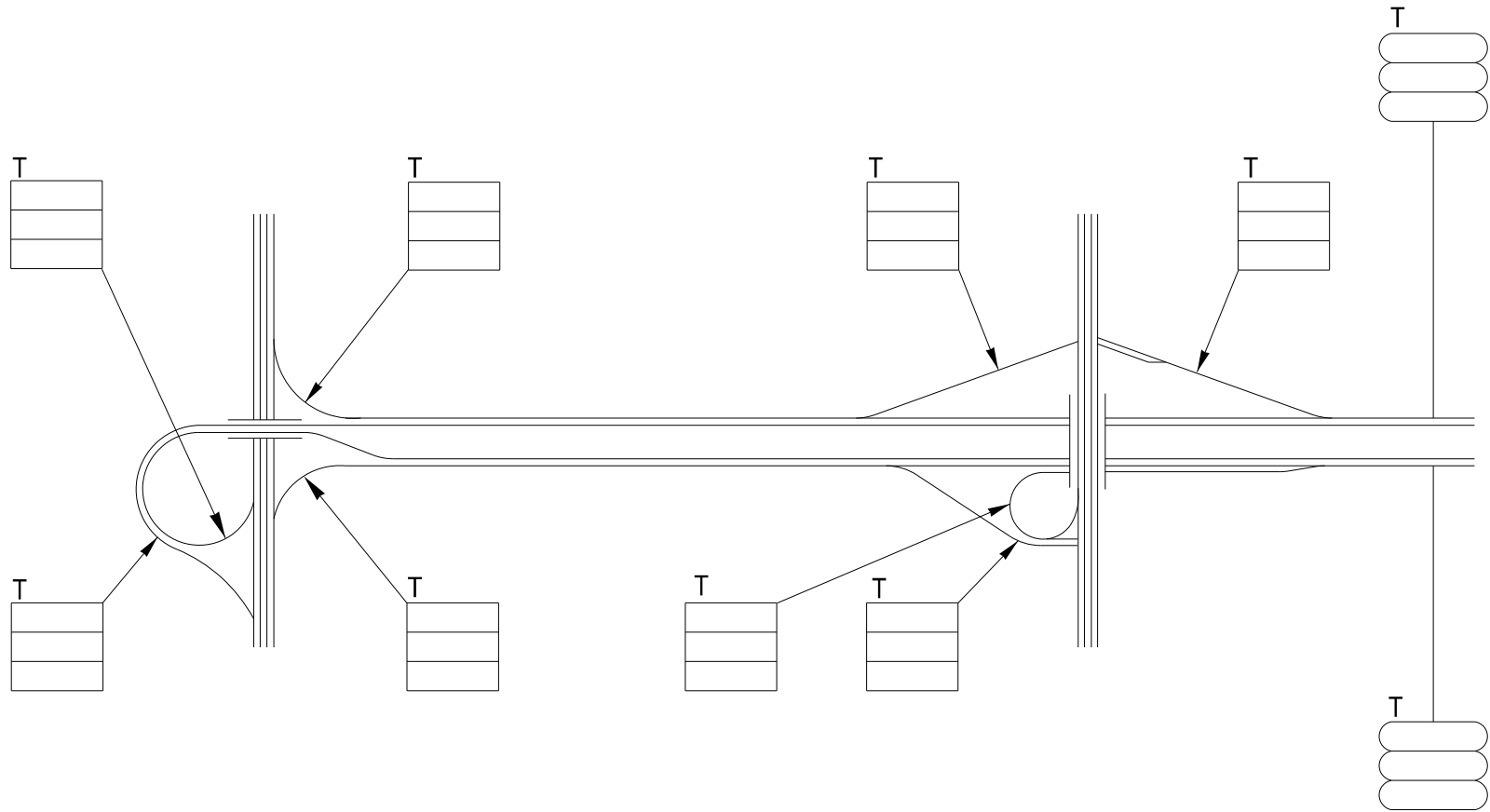

SR 518
SW 148TH ST

SW 146TH ST

SW 128TH ST

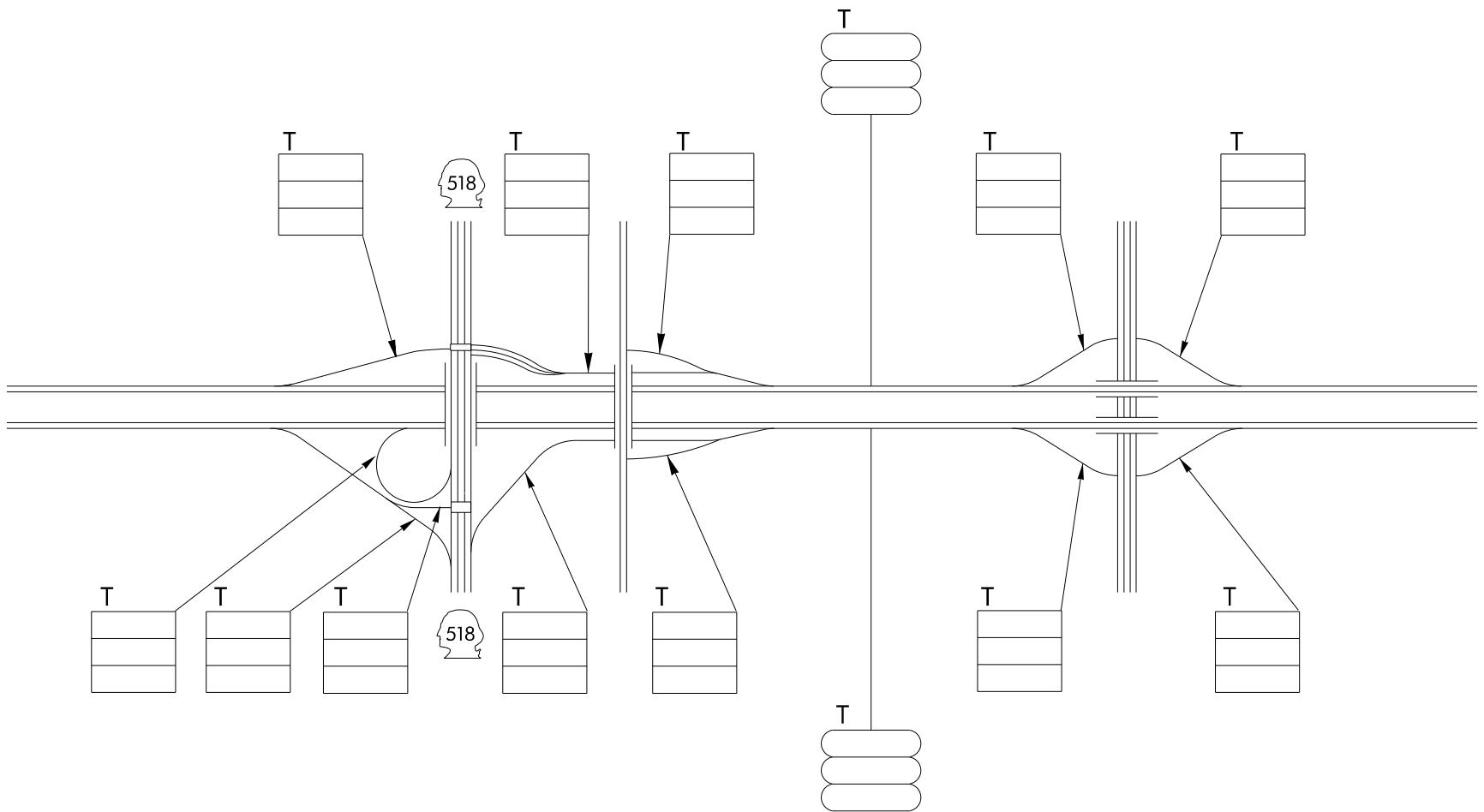

 Washington State Department of Transportation	 509	2 OF 4
----------------------------------------------------------------------------------------------------------------------------------------	-------------------------------------------------------------------------------------------	--------------

GLENDALE WAY S
5TH AVE S /S 112TH ST

1ST AVE S
S CLOVERDALE ST

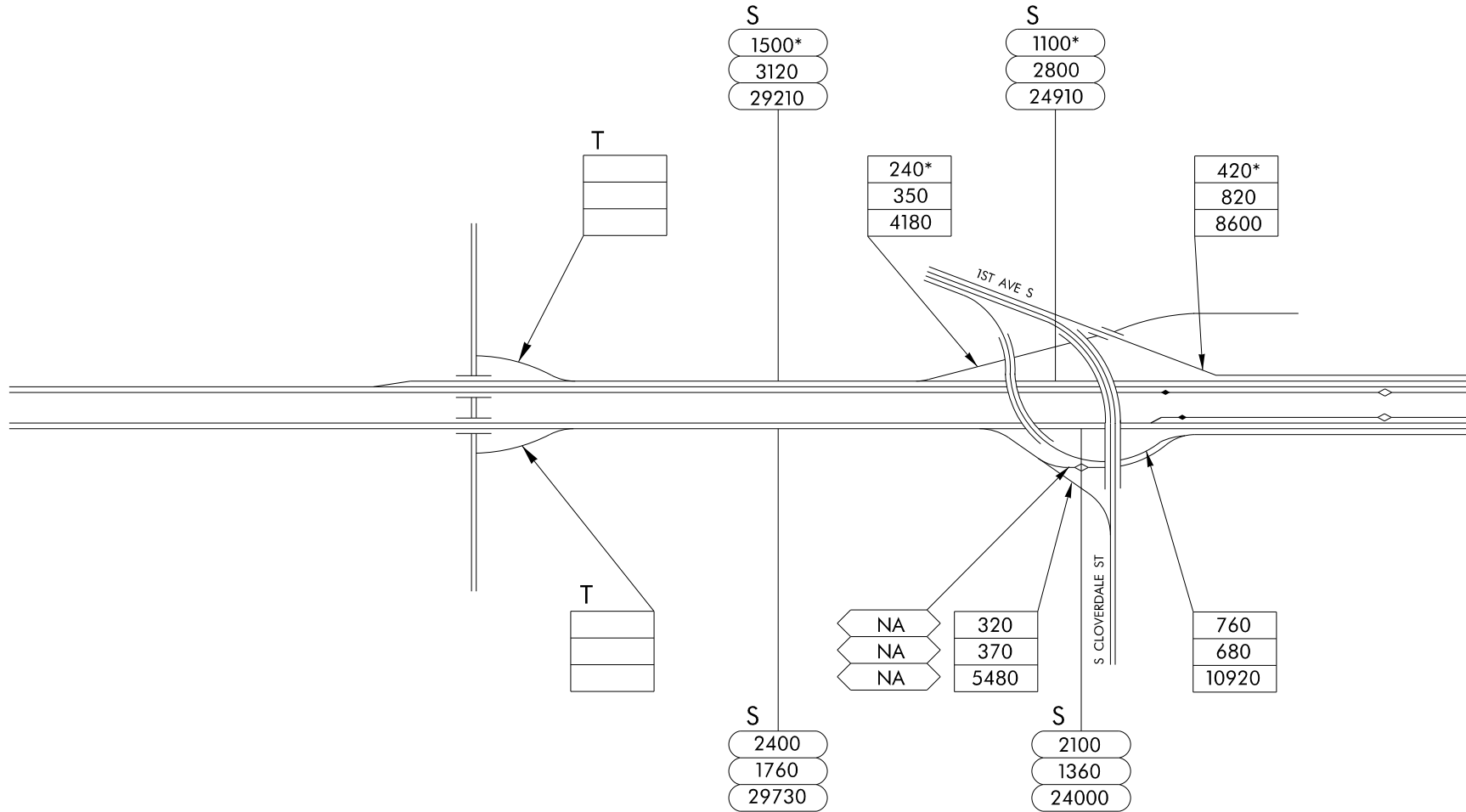

Washington State
Department of Transportation



3
OF
4

SR 509
S HOLDEN ST



1ST AVE BRIDGE S

1160* 160*
2570 710
25560 4690

190
290
3240

400*
660
7150

509

99

310*
420
5530

99

980*
970
13890

2010 550
1470 150
25990 3400

	Washington State Department of Transportation		4
			OF
			4

1ST AVE S

SR 509

DES MOINES
MEMORIAL DR S

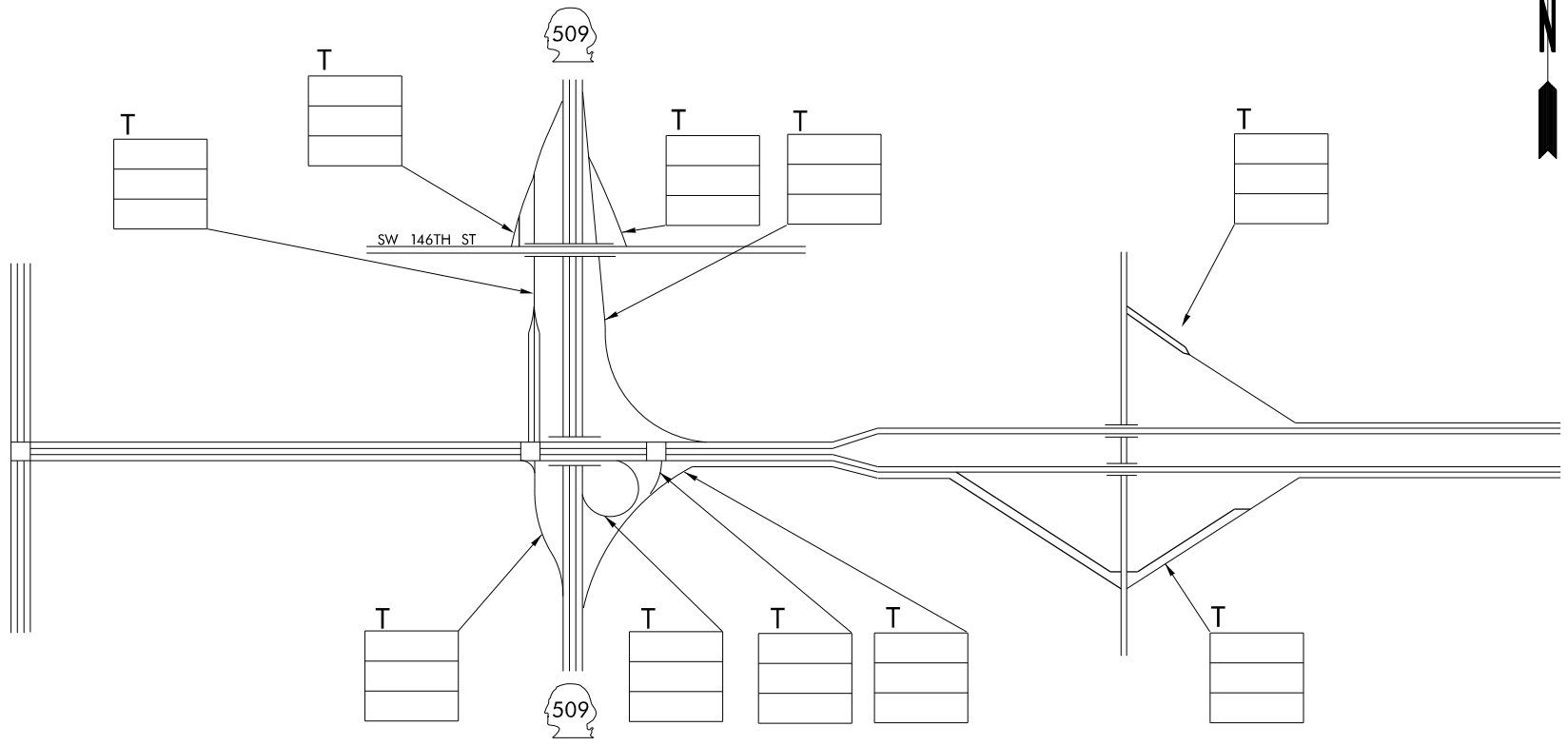

 Washington State Department of Transportation	 518	1 OF 3
----------------------------------------------------------------------------------------------------------------------------------------	-------------------------------------------------------------------------------------------	--------------

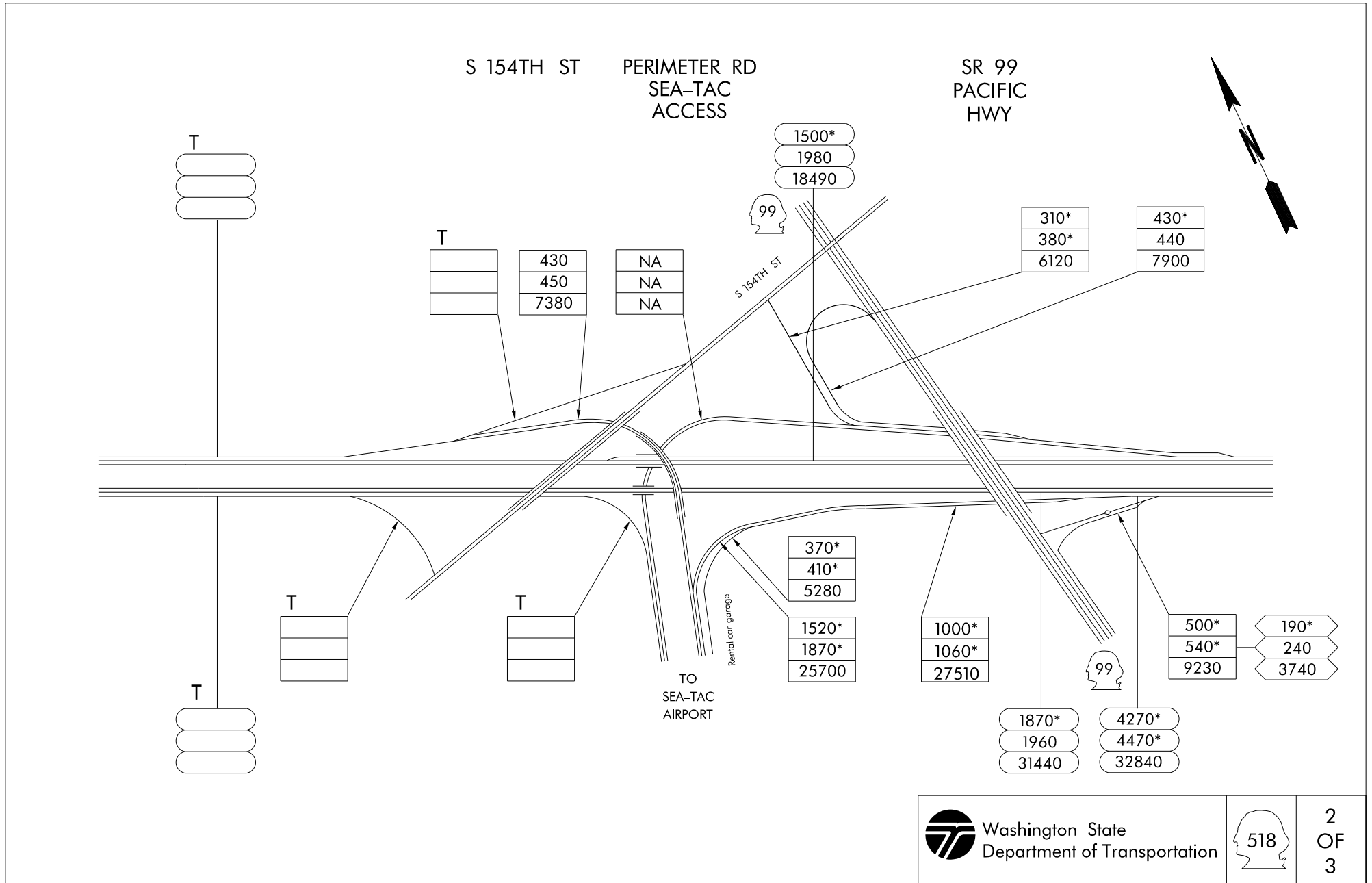

42ND AVE S

51ST AVE S

I-5



3860
4070
74400

3540
3400*
66490

460*
720
7890

1010*
1030*
17870

850
770*
14360

1030*
1220
17420

2720
2960
53970

940
950
15810

570*
590*
7260

1620*
1730*
29960

4270*
4470*
47180

3440*
3660*
41020



Washington State
Department of Transportation



518

3
OF
3

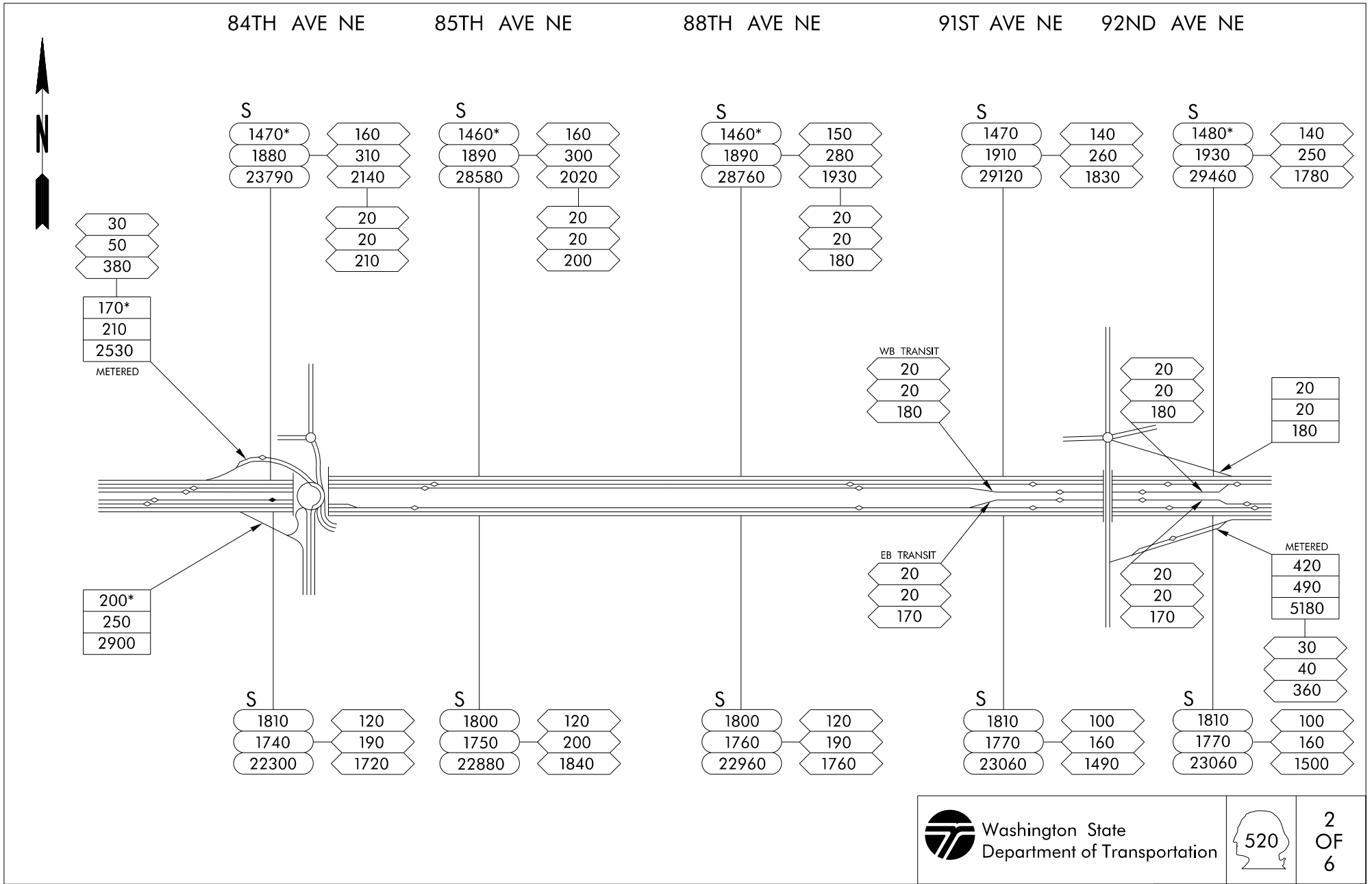

98TH AVE NE

104TH AVE NE
BELLEVUE WAY

108TH AVE NE 109TH AVE NE

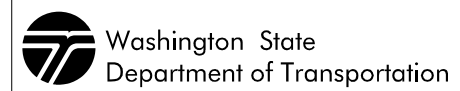
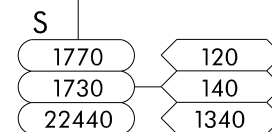
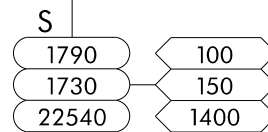
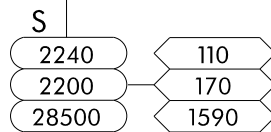
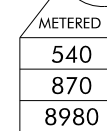
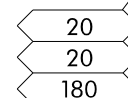
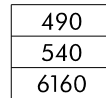
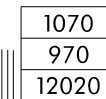
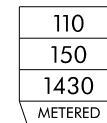
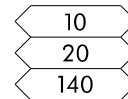
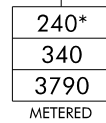
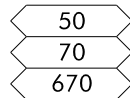
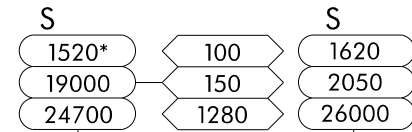
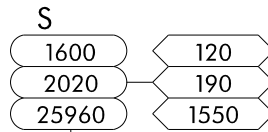
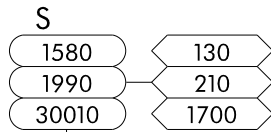

3 OF 6

I-405

124TH AVE NE
NORTHUP WAY

130TH AVE NE

140TH AVE NE

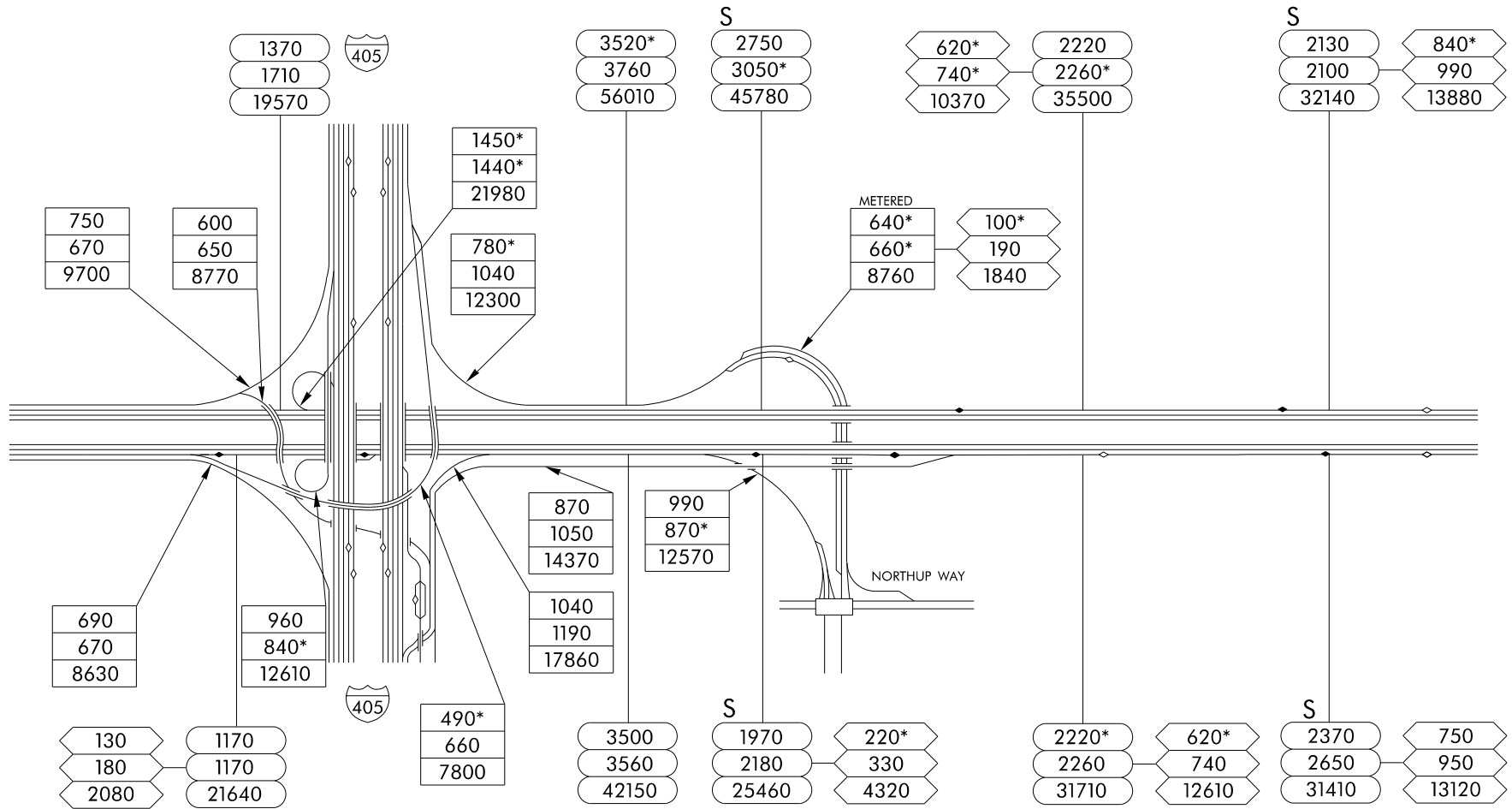

148TH AVE NE

NE 36TH ST

NE 40TH ST

NE 51ST ST

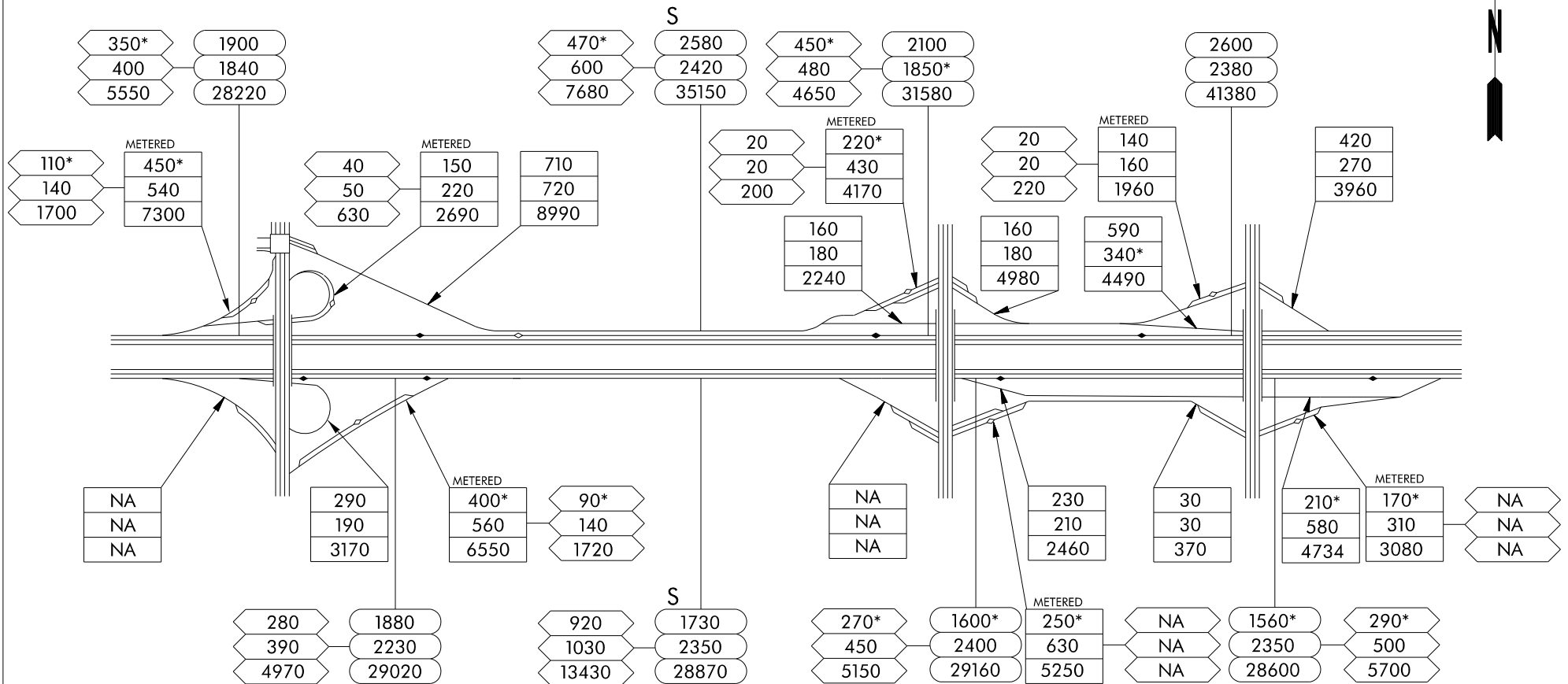

	Washington State Department of Transportation		5 OF 6
--	--------------------------------------------------	--	--------------

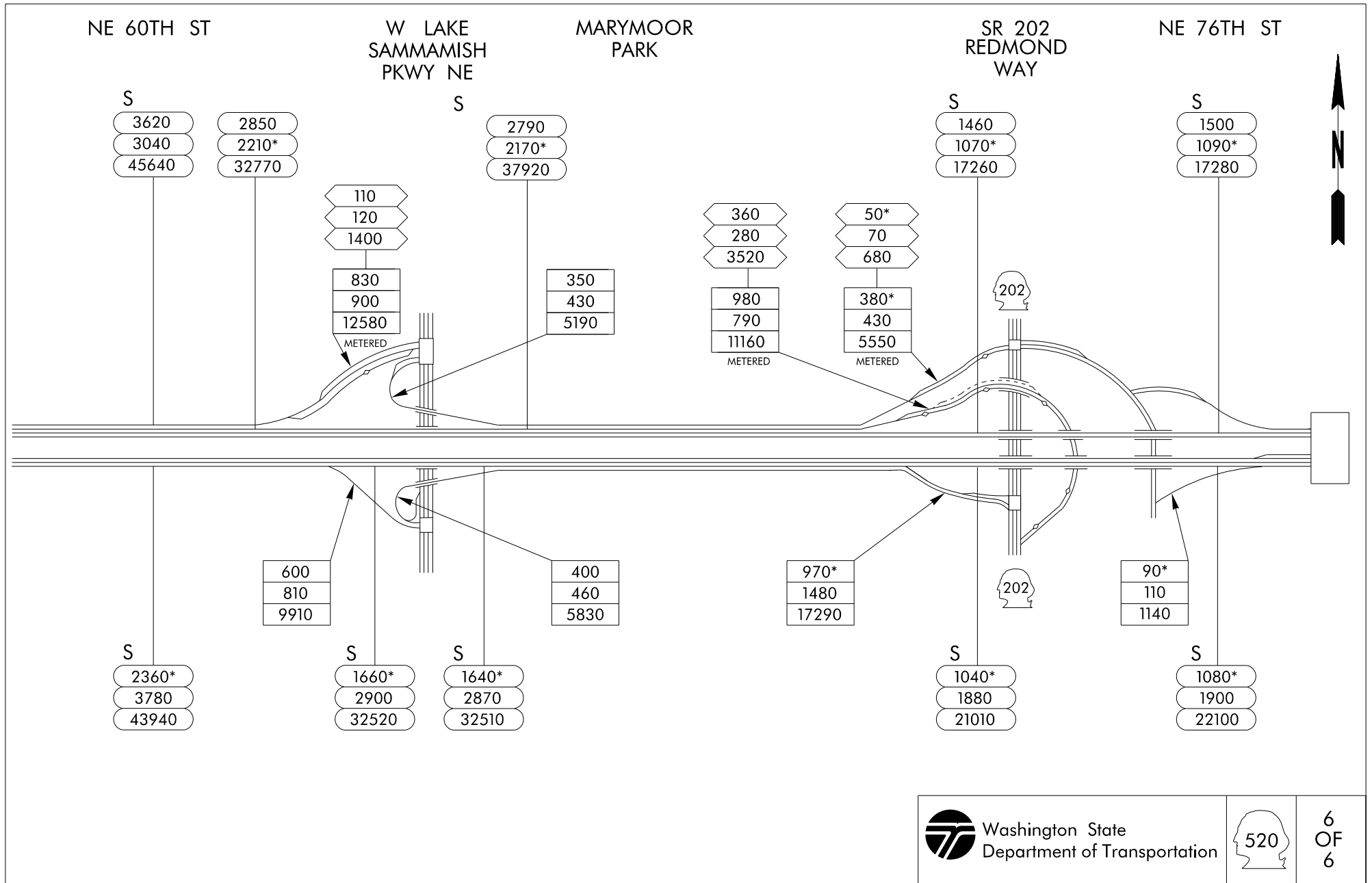

68TH AVE NE

83RD PL NE



690*
800
10210

860
1250
10140

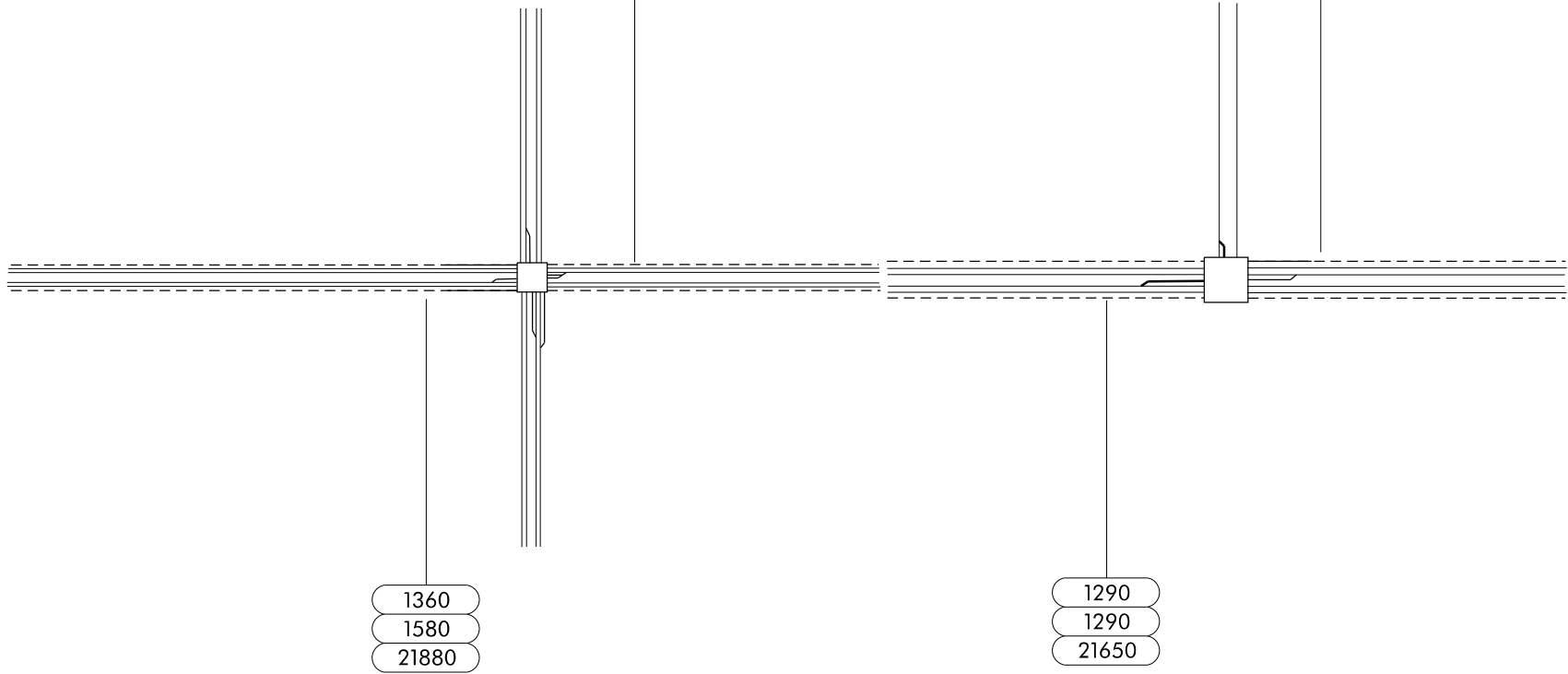

1360
1580
21880

1290
1290
21650



Washington State
Department of Transportation



1
OF
5

132ND AVE NE
SR 202



I-405

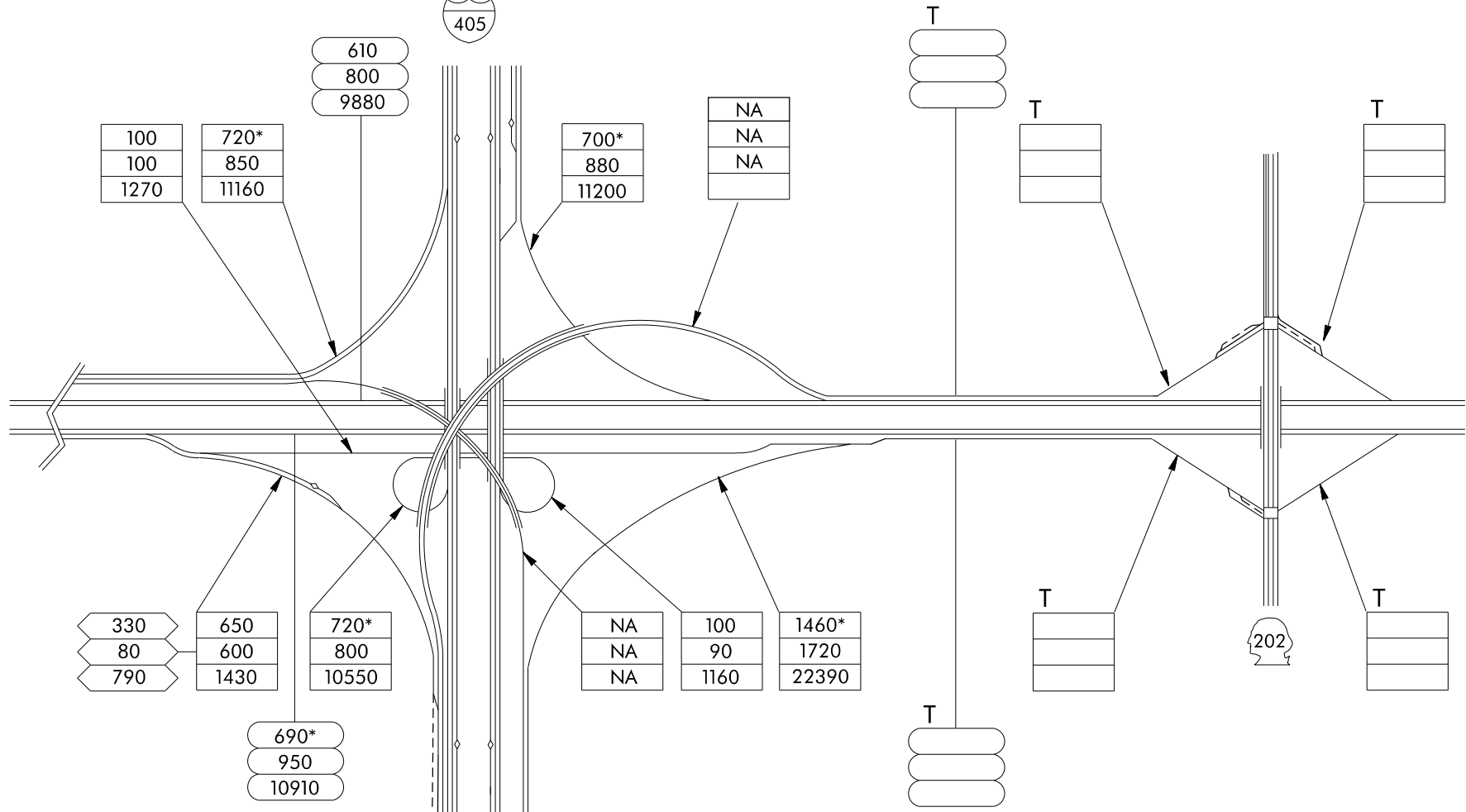

	<p>Washington State Department of Transportation</p>		<p>2 OF 5</p>
--	----------------------------------------------------------	--	-----------------------

NE 195TH ST

SR 9
WOODINVILLE CUT-OFF

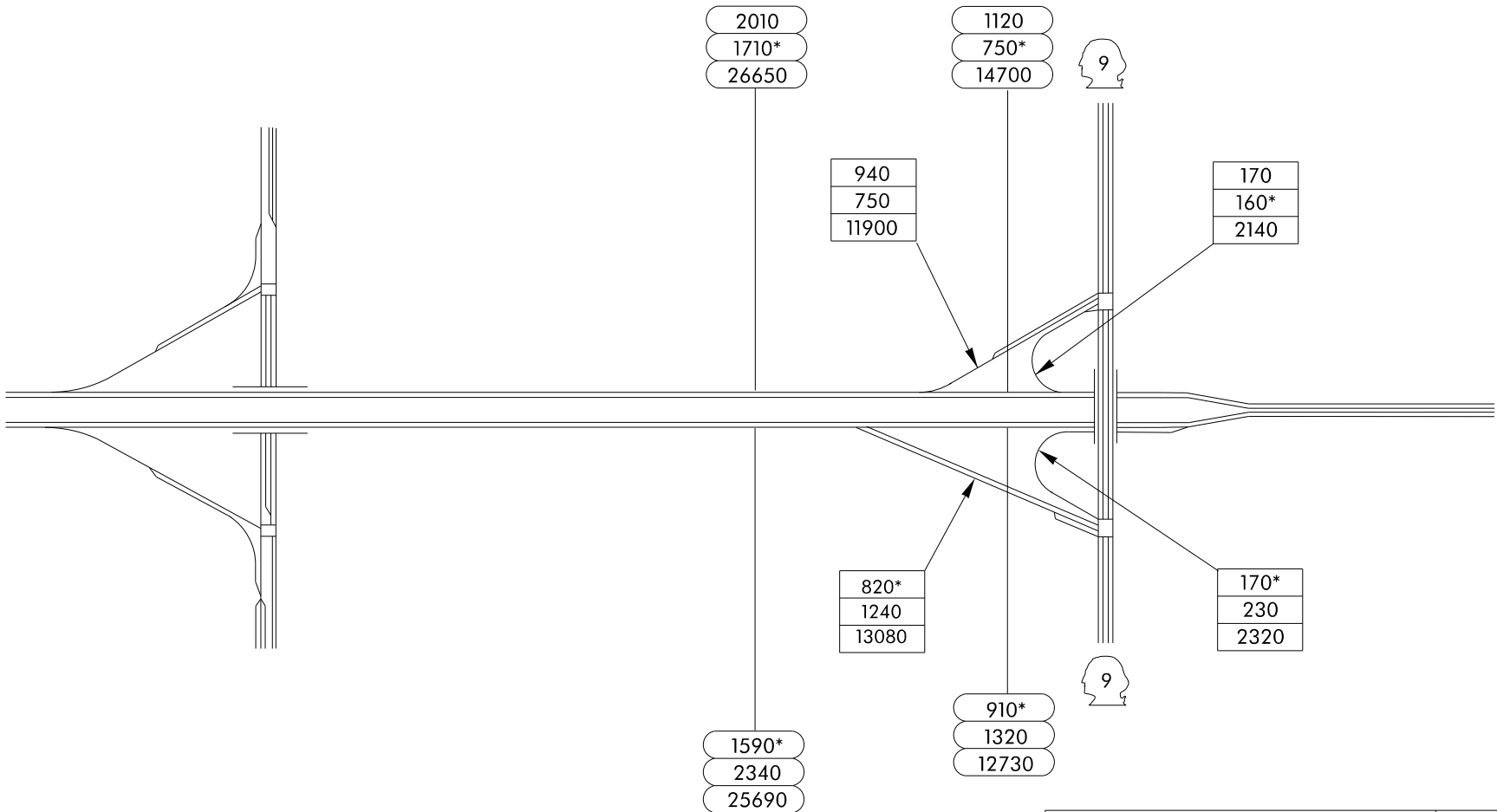

Washington State
Department of Transportation



3
OF
5

PARADISE LAKE RD

ECHO LAKE RD
FALES RD

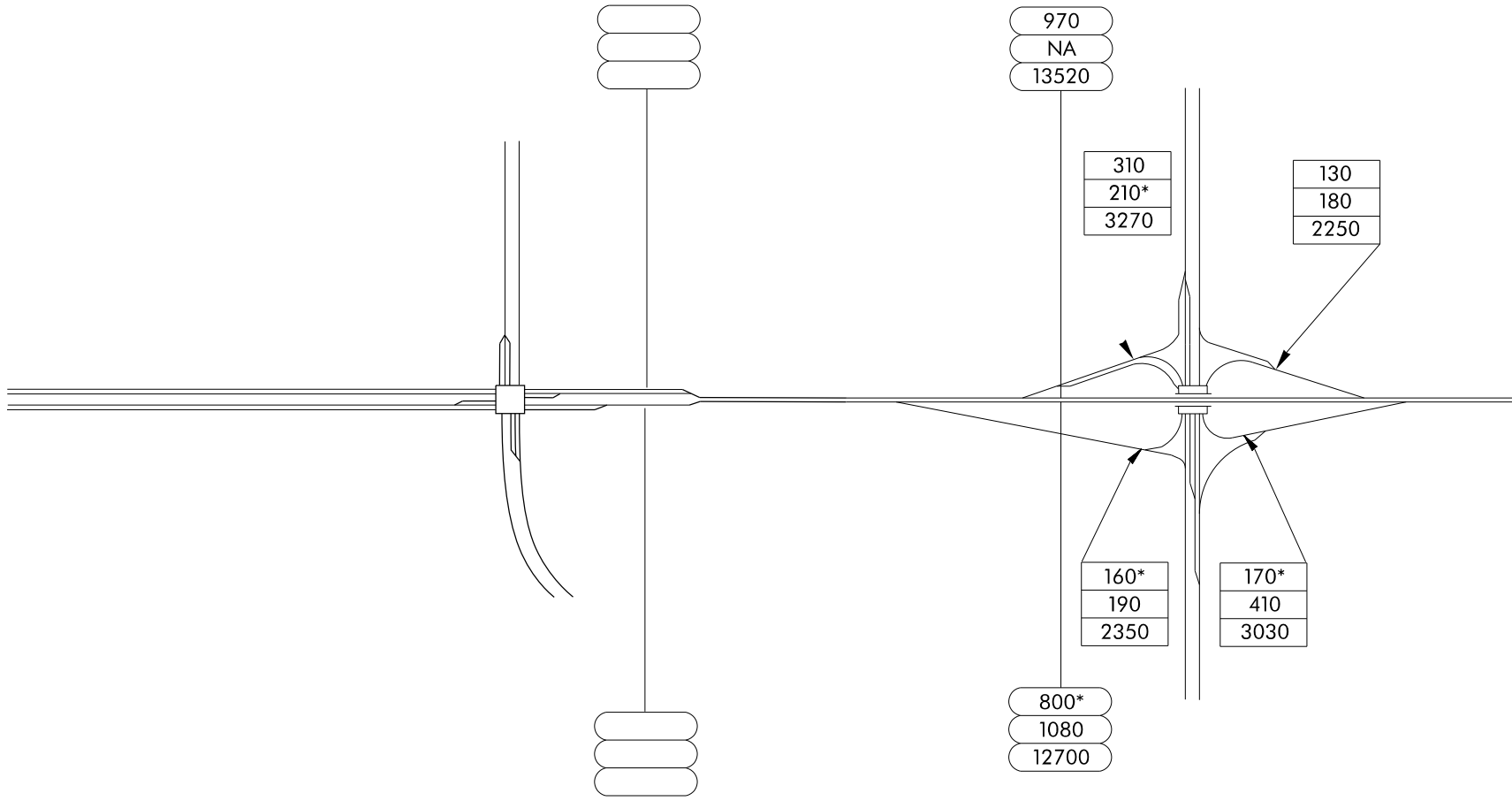

Washington State
Department of Transportation



4
OF
5

SNOHOMISH RIVER BRIDGE

W MAIN ST

US 2

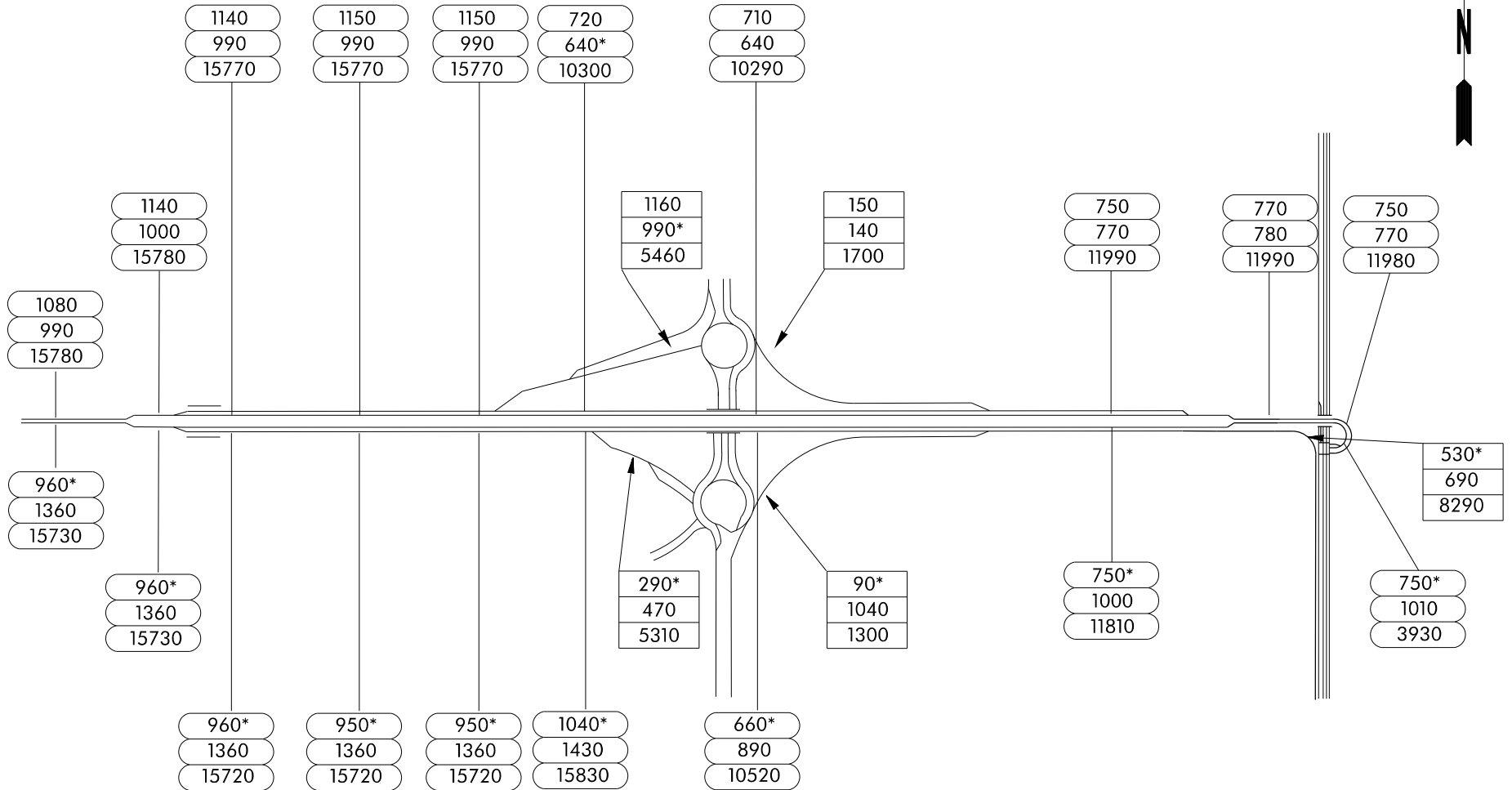

	Washington State Department of Transportation		5



ALDERWOOD
MALL PKWY

164TH ST SW

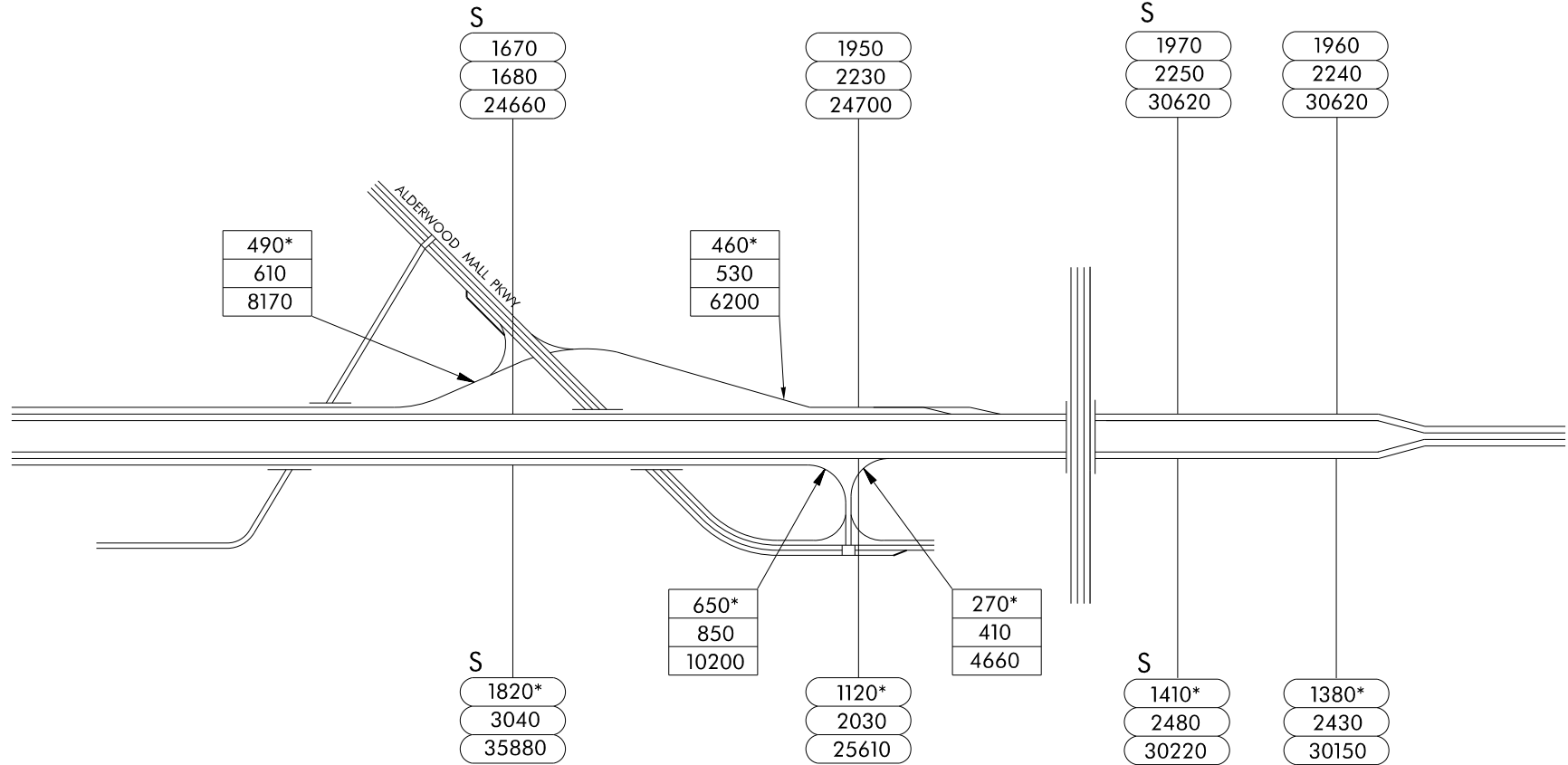

Washington State
Department of Transportation



1
OF
2



SR 99
PACIFIC HWY

LINCOLN WAY

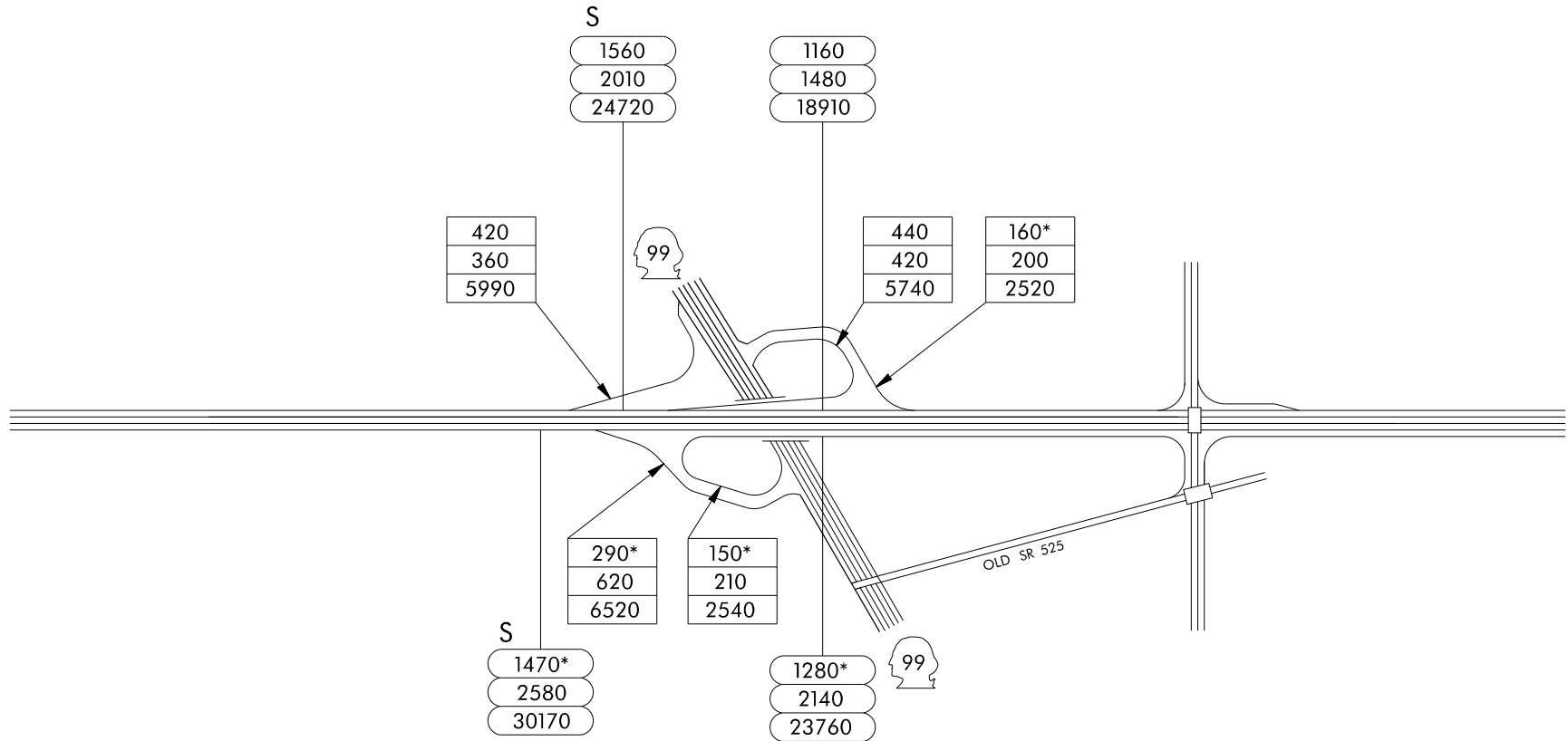

Washington State
Department of Transportation



2
OF
2

AIRPORT RD

SEAWAY BLVD
20TH AVE W

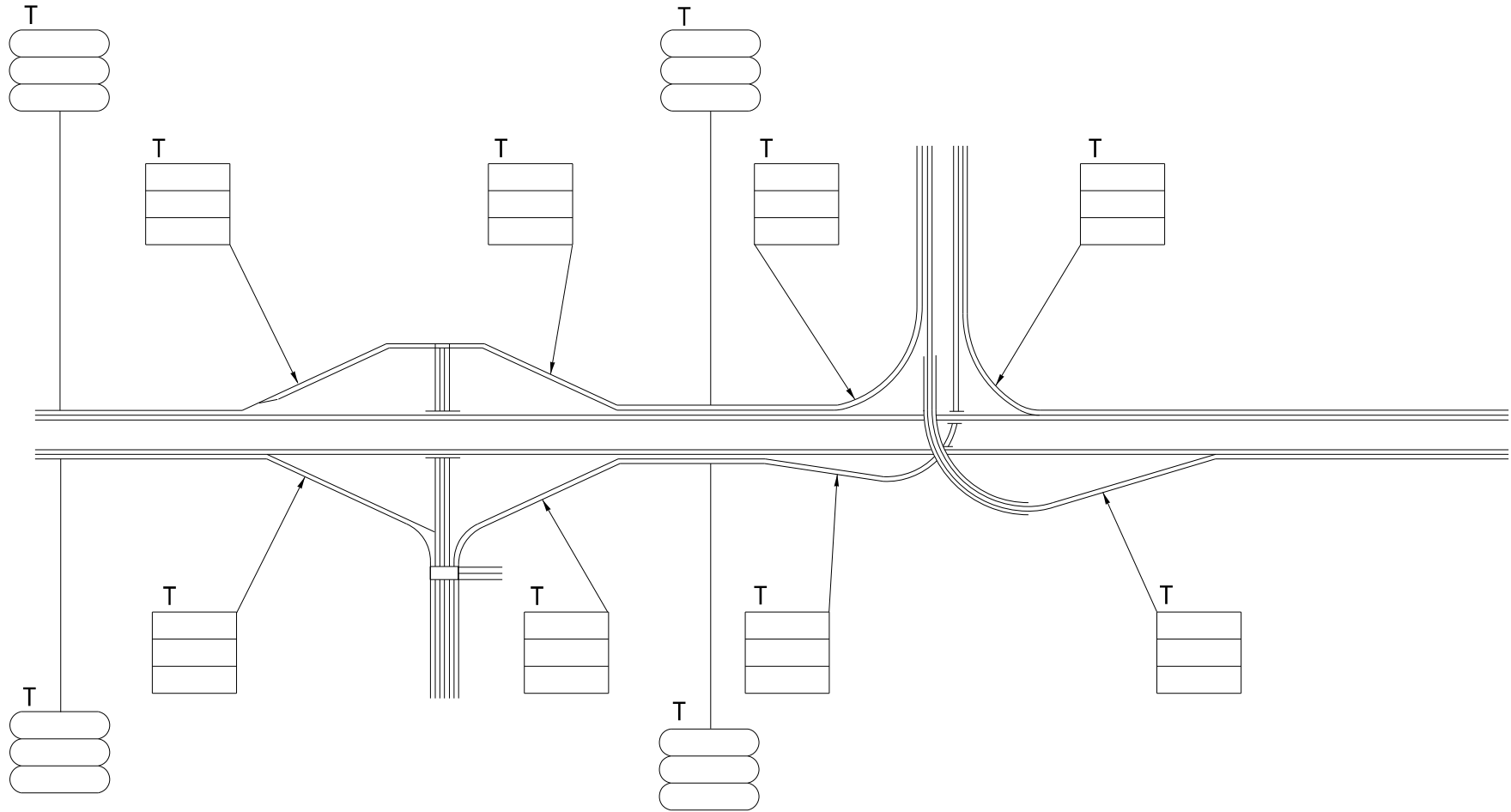

Washington State
Department of Transportation



1
OF
2

EVERGREEN WY

I-5

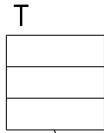
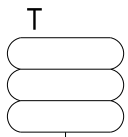

2190*
1710*
22860

830*
1110
15030

1130
780*
12820

1320*
1280*
16652



NA
NA
NA

NA
NA
NA

100*
210
2090

450*
860
9060

950*
2320
21080

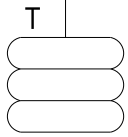

Washington State
Department of Transportation



2
OF
2

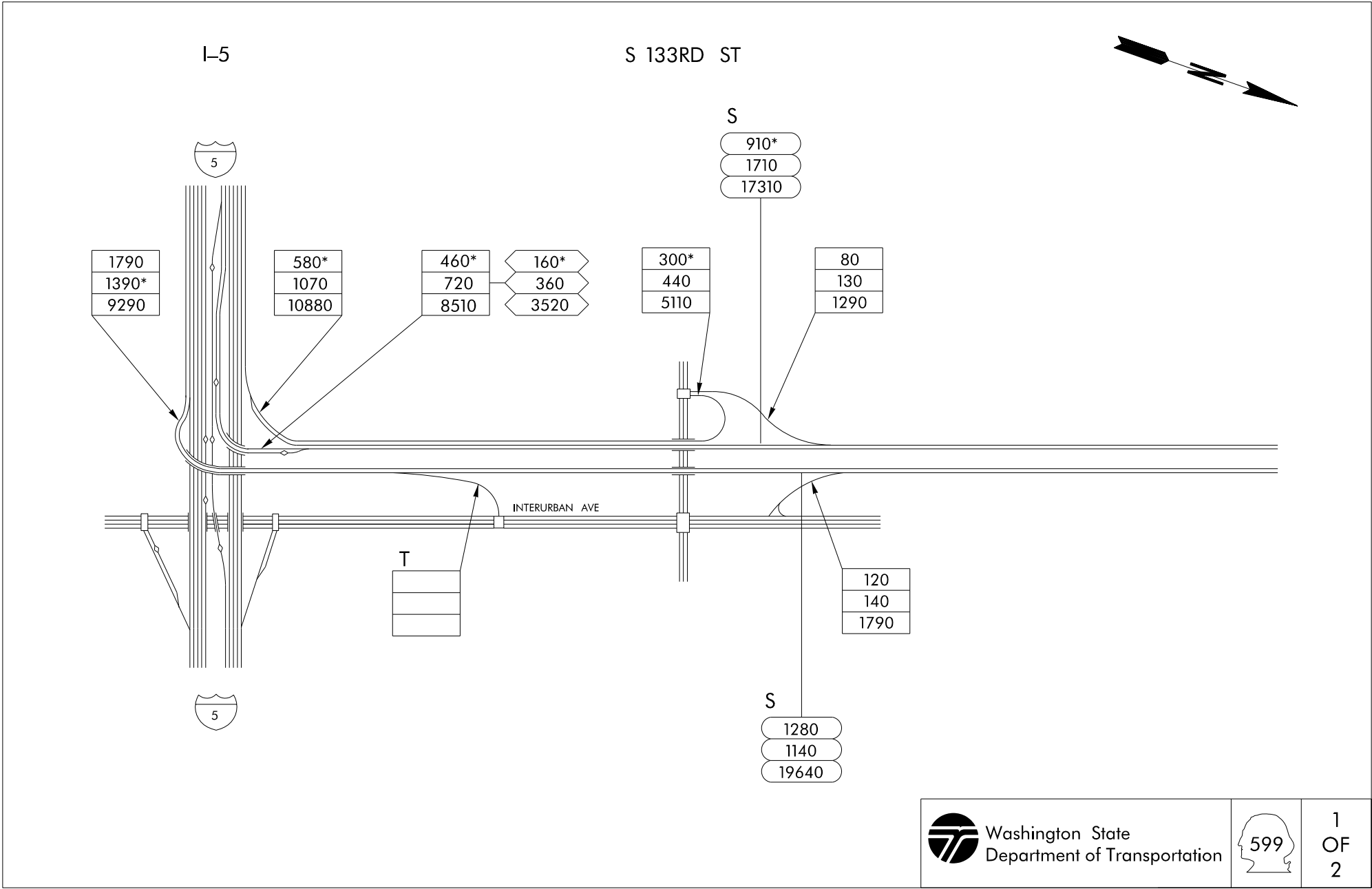

METRO BUS BARN

SR 99
TUKWILA INTERNATIONAL BLVD

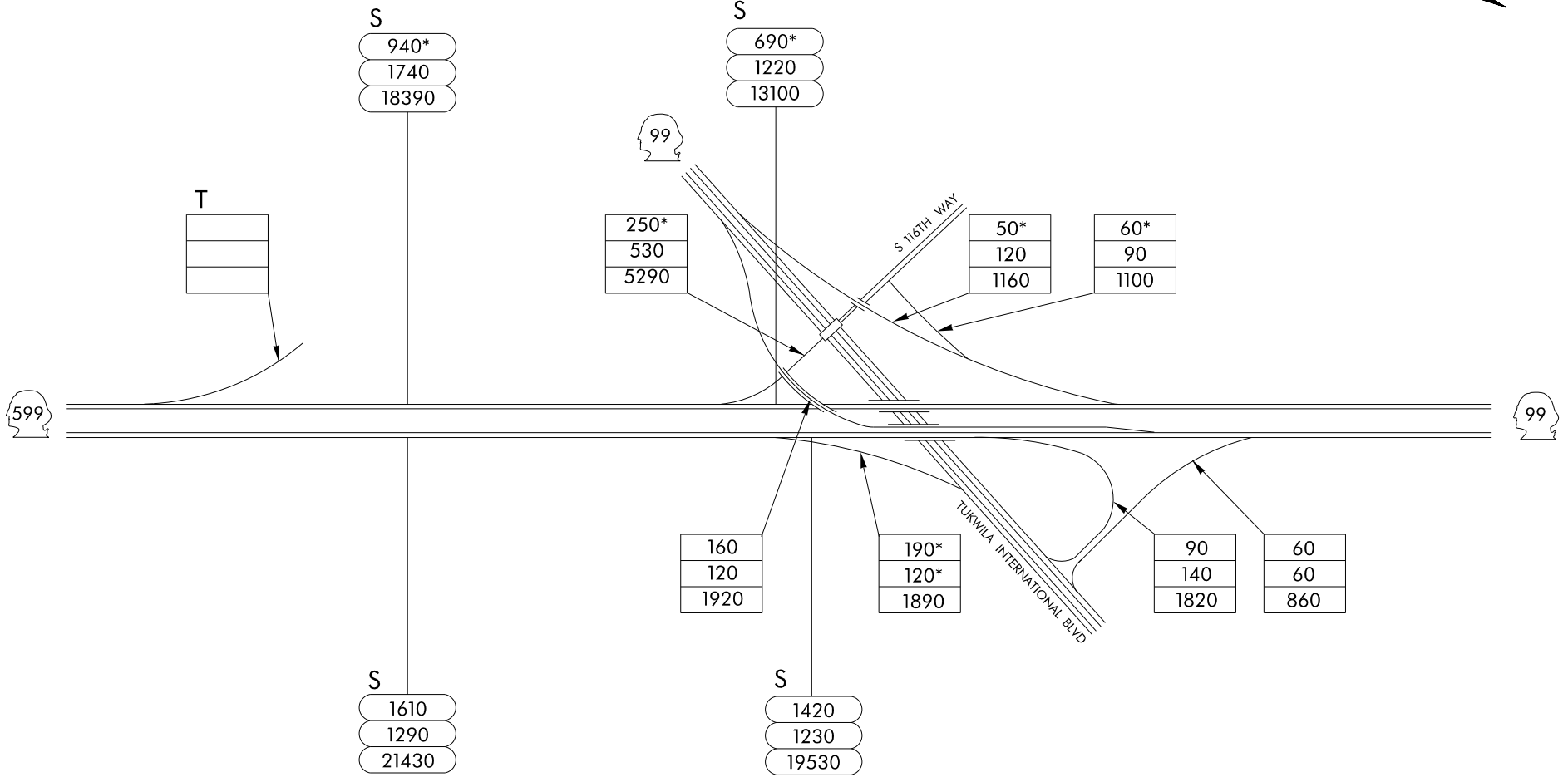
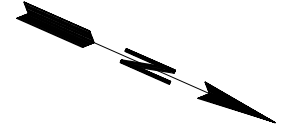

	Washington State		2
	Department of Transportation		OF
			2

BICKFORD AVE

SR 9

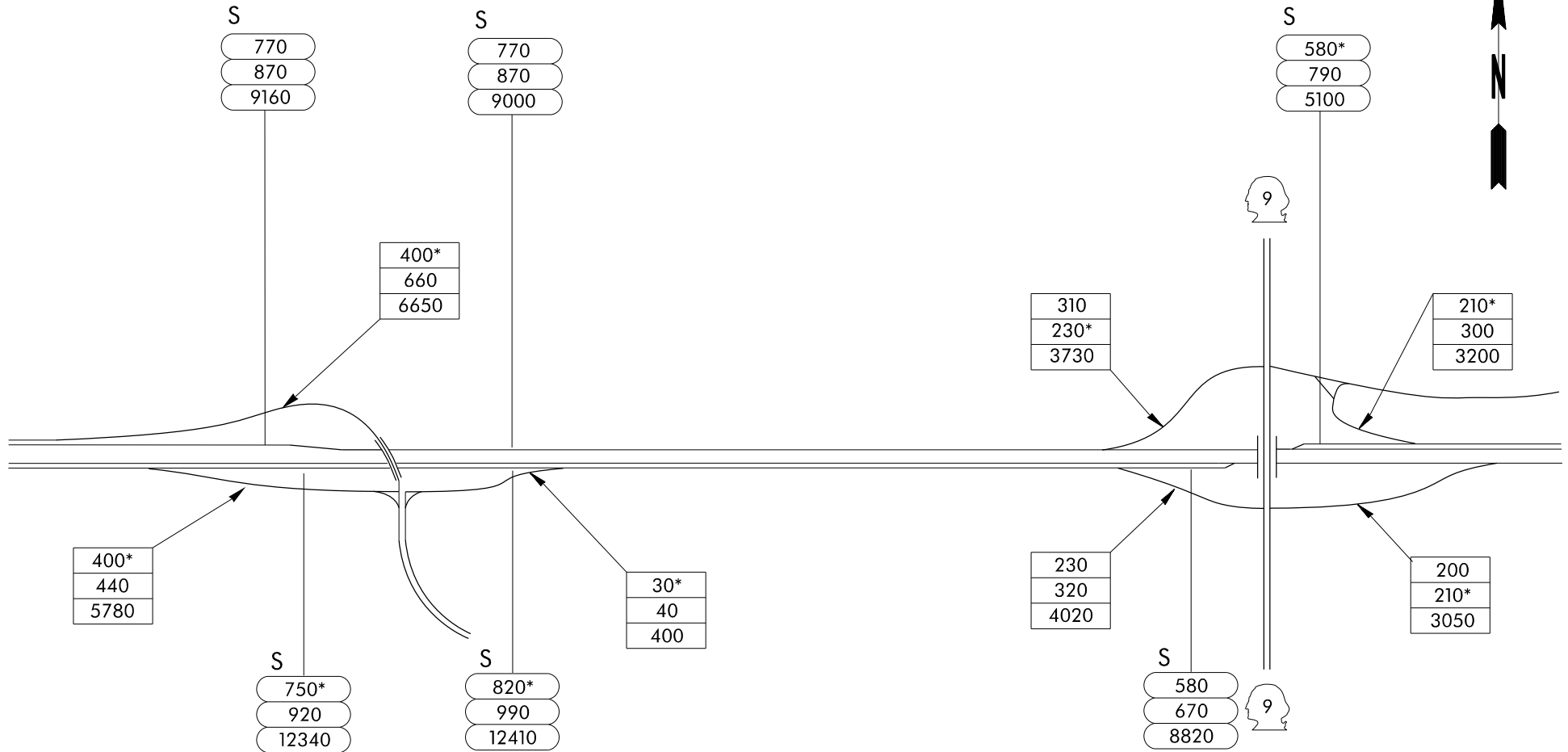

SR 522

RICE RD

S
920*
970
8040

S
510*
580
7750

S
1000*
1110
12000

S
NA
NA
NA

APPROXIMATELY
9.25 MILES

APPROXIMATELY
10.01 MILES



Washington State
Department of Transportation



2
OF
2

APPENDIX

For this 2023 traffic volume summary report, the standard AM and PM peak periods are defined as 6:00 AM to 10:00 AM and 2:00 PM to 7:00 PM, respectively. Listed below are the ramp, collector distributor (CD), and mainline stations in which the AM and/or PM peak hourly volumes began outside the above peak periods. They are arranged by types and directions.

Route	Sheet No.	Location	AM	PM
I-5	1 of 32	005es13969:_MN_Stn	11:00 AM	1:00 PM
		005es13969:_MNH__5	5:00 AM	-
		005es13969:_MS_Stn	11:00 AM	-
		005es13969:_MSH__5	11:00 AM	-
		005es14015:_MN_Stn	11:00 AM	1:00 PM
		005es14015:_MNH__5	5:00 AM	-
		005es14015:_MS_Stn	11:00 AM	-
		005es14015:_MSH__5	11:00 AM	-
		005es14064:_MN_Stn	11:00 AM	1:00 PM
		005es14064:_MNH__5	5:00 AM	-
		005es14064:_MS_Stn	11:00 AM	-
		005es14064:_MSH__5	11:00 AM	-
		005es14064:_MN_O_1	11:00 AM	12:00 PM
		005es14126:_MN_Stn	11:00 AM	1:00 PM
		005es14126:_MNH__5	5:00 AM	-
		005es14126:_MS_Stn	11:00 AM	-
	005es14126:_MSH__5	11:00 AM	-	
	2 of 32	018es00020:_ME_O_1	11:00 AM	1:00 PM
		005es14150:_MS_O_1	11:00 AM	-
		005es14150:_MS_O_2	11:00 AM	1:00 PM
		005es14150:AMW_X_1	11:00 AM	-
		005es14176:_MN_Stn	11:00 AM	1:00 PM
		005es14176:_MNH__5	5:00 AM	-
		005es14176:MMS_Stn	11:00 AM	-
		005es14176:_MSH__5	11:00 AM	-
		005es14176:_MS_P_1	-	1:00 PM
		005es14176:_MS_P_2	11:00 AM	-
		005es14220:_MN_P_1	-	1:00 PM
		005es14221:MMN_Stn	5:00 AM	1:00 PM
		005es14221:_MNH__5	5:00 AM	-
		005es14221:_MN_P_1	-	1:00 PM
		005es14221:_MN_P_2	-	12:00 PM
005es14221:_MN_X_1		-	12:00 PM	
005es14221:_MS_Stn	11:00 AM	-		
005es14221:_MSH__5	11:00 AM	-		
005es14221:_MS_X_1	11:00 AM	-		
005es14277:_MN_Stn	5:00 AM	1:00 PM		
005es14277:_MNH__5	5:00 AM	-		

	005es14277:_MS_Stn	11:00 AM	-
	005es14277:_MSH_5	11:00 AM	-
	005es14321:_MN_Stn	11:00 AM	1:00 PM
	005es14321:_MNH_5	5:00 AM	-
	005es14321:_MS_Stn	11:00 AM	-
	005es14321:_MSH_5	11:00 AM	-
	005es14364:_MN_Stn	5:00 AM	1:00 PM
	005es14364:_MNH_5	5:00 AM	-
	005es14364:_MNHO_1	5:00 AM	-
	005es14364:_MNHX_1	11:00 AM	-
	005es14364:MMS_Stn	11:00 AM	-
	005es14364:_MSHStn	11:00 AM	-
	005es14364:_MSHO_1	11:00 AM	-
	005es14364:_MSHP_1	11:00 AM	-
	005es14364:_MS_P_2	11:00 AM	-
	005es14364:_MS_X_1	11:00 AM	-
	005es14364:_MSHX_1	11:00 AM	-
	005es14364:_MS_X_2	11:00 AM	-
	005es14364:_MS_X_3	11:00 AM	-
	005es14398:MMN_Stn	5:00 AM	1:00 PM
	005es14398:_MNH_5	5:00 AM	-
	005es14398:_MN_P_2	11:00 AM	1:00 PM
	005es14398:_MN_P_3	-	1:00 PM
	005es14398:_MN_x_1	11:00 AM	-
	005es14460:_MN_Stn	5:00 AM	1:00 PM
	005es14460:_MNH_5	5:00 AM	-
	005es14460:_MS_Stn	11:00 AM	-
	005es14460:_MSH_5	11:00 AM	-
3 of 31	005es14522:_MN_Stn	11:00 AM	1:00 PM
	005es14522:_MNH_5	5:00 AM	-
	005es14522:_MS_Stn	11:00 AM	-
	005es14522:_MSH_5	11:00 AM	-
	005es14575:_MN_Stn	11:00 AM	1:00 PM
	005es14575:_MNH_5	5:00 AM	-
	005es14575:_MS_Stn	11:00 AM	-
	005es14575:_MSH_5	11:00 AM	-
	005es14630:_MN_Stn	11:00 AM	1:00 PM
	005es14630:_MNH_5	5:00 AM	-
	005es14630:_MS_Stn	11:00 AM	-
	005es14630:_MSH_5	11:00 AM	-
	005es14676:MMS_Stn	11:00 AM	-
	005es14676:_MSH_5	11:00 AM	-
	005es14676:_MS_P_1	11:00 AM	-
	005es14701:MMN_Stn	11:00 AM	1:00 PM
	005es14701:_MNH_5	5:00 AM	-
	005es14701:_MN_P_1	-	1:00 PM

	005es14701:_MN_P_2	-	1:00 PM
	005es14727:_MN_Stn	11:00 AM	1:00 PM
	005es14727:_MNH_5	5:00 AM	-
4 of 31	005es14771:_MN_Stn	11:00 AM	1:00 PM
	005es14771:_MNH_5	5:00 AM	-
	005es14771:_MS_Stn	11:00 AM	-
	005es14771:_MSH_5	11:00 AM	-
	005es14807:_MN_Stn	11:00 AM	1:00 PM
	005es14807:_MNH_5	5:00 AM	-
	005es14807:_MS_Stn	11:00 AM	-
	005es14807:_MSH_5	11:00 AM	-
	005es14868:_MN_Stn	11:00 AM	1:00 PM
	005es14868:_MNH_5	5:00 AM	-
	005es14868:_MS_Stn	11:00 AM	-
	005es14868:_MSH_5	11:00 AM	-
	005es14905:MMS_Stn	11:00 AM	-
	005es14905:_MSH_5	11:00 AM	-
	005es14905:_MS_P_1	11:00 AM	-
	005es14906:MMN_Stn	11:00 AM	1:00 PM
	005es14906:_MNH_5	5:00 AM	1:00 PM
	005es14906:_MN_P_1	-	1:00 PM
	005es14937:MMN_Stn	11:00 AM	1:00 PM
	005es14937:_MNH_5	5:00 AM	-
	005es14937:_MN_P_1	-	1:00 PM
	005es15036:_MN_Stn	11:00 AM	1:00 PM
	005es15036:_MS_Stn	11:00 AM	-
	005es15036:_MSH_5	11:00 AM	-
5 of 31	005es15125:_MN_Stn	11:00 AM	1:00 PM
	005es15125:_MNH_5	5:00 AM	-
	005es15125:_MN_X_1	-	1:00 PM
	005es15125:MMS_Stn	11:00 AM	-
	005es15125:_MSH_5	11:00 AM	-
	005es15125:_MS_P_1	11:00 AM	-
	005es15125:_MS_P_2	11:00 AM	-
	005es15214:_MN_Stn	11:00 AM	1:00 PM
	005es15214:_MN_X_1	-	1:00 PM
	005es15214:MMS_Stn	11:00 AM	1:00 PM
	005es15214:_MSH_5	11:00 AM	-
	005es15214:_MS_P_1	11:00 AM	-
	005es15214:_MS_P_2	11:00 AM	-
	005es15240:_MN_P_2	11:00 AM	-
	005es15280:_MN_Stn	11:00 AM	1:00 PM
	005es15280:_MNH_5	-	1:00 PM
	005es15280:_MS_Stn	11:00 AM	1:00 PM
	005es15280:_MSH_6	11:00 AM	-
	005es15315:_MN_Stn	11:00 AM	1:00 PM

	005es15315:_MNH_5	-	1:00 PM
	005es15315:_MS_Stn	11:00 AM	1:00 PM
	005es15315:_MSH_6	11:00 AM	-
6 of 31	005es15348:_MN_Stn	11:00 AM	1:00 PM
	005es15348:_MS_Stn	11:00 AM	-
	005es15348:_MSH_7	11:00 AM	-
	005es15410:MMS_Stn	11:00 AM	-
	005es15410:_MS_P_1	11:00 AM	
	005es15410:_MS_P_2	11:00 AM	1:00 PM
	005es15410:_MSHP_2	11:00 AM	-
	005es15465:_MN_Stn	-	1:00 PM
	005es15465:_MN_O_2	11:00 AM	1:00 PM
	005es15465:_MS_Stn	11:00 AM	-
	005es15465:_MSH_6	11:00 AM	-
	005es15465:_MS_O_1	11:00 AM	-
	005es15465:_MS_X_1	11:00 AM	-
	005es15465:_MS_X_2	-	12:00 PM
	005es15480:MMN_Stn	-	1:00 PM
	005es15480:_MN_P_1	11:00 AM	-
	005es15480:_MN_P_2	11:00 AM	-
	005es15480:_MNHP_2	11:00 AM	-
7 of 31	005es15531:_MN_Stn	-	1:00 PM
	005es15531:_MNH_6	-	1:00 PM
	005es15531:_MS_Stn	11:00 AM	-
	005es15531:_MSH_7	11:00 AM	-
	005es15569:_MN_Stn	11:00 AM	1:00 PM
	005es15569:_MNH_5	-	1:00 PM
	005es15569:_MN_X_2	-	1:00 PM
	005es15569:MMS_Stn	11:00 AM	-
	005es15569:_MSH_6	11:00 AM	-
	005es15569:_MS_P_1	11:00 AM	-
	005es15569:_MSHP_1	11:00 AM	-
	005es15587:MMS_Stn	11:00 AM	-
	005es15587:_MS_P_1	11:00 AM	-
	005es15587:_MS_P_2	11:00 AM	-
	005es15608:MMN_Stn	11:00 AM	1:00 PM
	005es15608:_MNH_5	-	1:00 PM
	005es15608:_MS_Stn	11:00 AM	-
	005es15608:_MSH_5	11:00 AM	-
	005es15608:_MS_X_1	11:00 AM	-
	005es15652:_MN_Stn	11:00 AM	1:00 PM
	005es15652:_MNH_5	-	1:00 PM
	005es15652:_MS_Stn	11:00 AM	-
	005es15652:_MSH_5	11:00 AM	-
8 of 31	005es15723:MMS_Stn	11:00 AM	-
	005es15723:_MSH_5	11:00 AM	-

	005es15723:_MS_P_1	11:00 AM	1:00 PM
	005es15723:_MSHP_1	11:00 AM	-
	005es15723:AME__1	11:00 AM	-
	005es15723:AME__2	11:00 AM	-
	005es15742:MMN_Stn	-	1:00 PM
	005es15742:_MNH_5	-	1:00 PM
	005es15742:AME__1	11:00 AM	-
	005es15792:MMN_Stn	-	1:00 PM
	005es15792:_MNH_5	-	1:00 PM
	005es15792:_MN_P_1	11:00 AM	-
	005es15792:_MN_P_2	11:00 AM	-
	005es15792:_MN_O_1	11:00 AM	-
	005es15792:_MN_X_1	-	1:00 PM
	005es15792:_CN_X_1	-	1:00 PM
	005es15792:_MS_Stn	11:00 AM	-
	005es15792:_MSH_5	11:00 AM	-
	005es15845:_MN_Stn	11:00 AM	1:00 PM
	005es15845:_MNH_5	-	1:00 PM
	005es15845:_MS_Stn	11:00 AM	-
	005es15845:_MSH_5	11:00 AM	-
	005es15892:_MN_Stn	11:00 AM	1:00 PM
	005es15892:_MNH_5	-	1:00 PM
	005es15892:_MS_Stn	11:00 AM	-
	005es15892:_MSH_5	11:00 AM	-
	005es15957:_MN_Stn	11:00 AM	1:00 PM
	005es15957:_MNH_5	-	1:00 PM
	005es15957:_MS_Stn	11:00 AM	-
	005es15957:_MSH_5	11:00 AM	-
9 of 31	005es15996:_MN_Stn	11:00 AM	1:00 PM
	005es15996:_MNH_5	-	1:00 PM
	005es15996:_MS_Stn	11:00 AM	-
	005es15996:_MSH_5	11:00 AM	-
	005es16064:_MN_Stn	11:00 AM	1:00 PM
	005es16064:_MNH_5	-	1:00 PM
	005es16064:_MS_Stn	11:00 AM	-
	005es16064:_MSH_5	11:00 AM	-
	005es16107:MMS_Stn	11:00 AM	-
	005es16107:_MSH_5	11:00 AM	-
	005es16107:_MS_P_1	11:00 AM	-
	005es16107:_MS_P_2	11:00 AM	-
	005es16107:_MSHP_2	11:00 AM	-
	005es16120:MMN_Stn	11:00 AM	1:00 PM
	005es16120:_MN_P_1	11:00 AM	1:00 PM
	005es16147:MMN_Stn	11:00 AM	1:00 PM
	005es16147:_MN_X_1	-	12:00 PM
	005es16186:_MN_Stn	11:00 AM	1:00 PM

	005es16186:_MS_Stn	11:00 AM	-
	005es16186:_MSH__5	11:00 AM	-
10 of 31	005es16272:_MN_X_1	11:00 AM	-
	005es16272:MMS_Stn	11:00 AM	-
	005es16272:_MSH__5	11:00 AM	-
	005es16272:_MS_O_1	11:00 AM	-
	005es16272:_MS_O_2	11:00 AM	-
	005es16302:_MN_Stn	11:00 AM	1:00 AM
	005es16302:_MN_O_1	11:00 AM	-
	005es16302:_MS_Stn	11:00 AM	-
	005es16302:_MSH__4	11:00 AM	-
	005es16319:_MN_P_1	11:00 AM	12:00 PM
	005es16396:_MS_Stn	11:00 AM	1:00 PM
	005es16396:_MSH__5	11:00 AM	-
11 of 31	005es16429:MMS_Stn	-	12:00 PM
	005es16429:_CS_X_1	-	12:00 PM
	005es16442:_MS_P_1	11:00 AM	-
	005es16442:_MS_P_2	11:00 AM	12:00 PM
	005es16442:_MS_P_3	11:00 AM	-
	005es16466:MMN_Stn	11:00 AM	-
	005es16466:_MN_Stn	11:00 AM	1:00 PM
	005es16466:_CN_P_1	11:00 AM	-
	005es16466:_CN_P_2	11:00 AM	-
	005es16466:MCN__1	-	1:00 PM
	005es16513:_MN_Stn	11:00 AM	-
	005es16513:_MS_Stn	11:00 AM	1:00 PM
	005es16513:_CS_Stn	11:00 AM	-
12 of 31	005es16551:_MN_X_1	-	12:00 PM
	005es16551:_MS_Stn	11:00 AM	-
	005es16551:_MSH__3	11:00 AM	-
	005es16551:_CS_O_1	11:00 AM	-
	005es16583:_MS_Stn	11:00 AM	12:00 PM
13 of 31	005es16440:_MN_P_1	11:00 AM	-
	005es16640:_MN_X_1	11:00 AM	-
	005es16640:_MS_Stn	11:00 AM	12:00 PM
	005es16661:_MS_P_1	11:00 AM	-
	005es16661:_MS_P_2	11:00 AM	-
	005es16701:_MS_Stn	11:00 AM	12:00 PM
	005es16704:_MS_X_1	11:00 AM	-
14 of 31	005es16732:_MS_Stn	11:00 AM	12:00 PM
	005es16756:MMS_Stn	11:00 AM	12:00 PM
	005es16802:_MS_Stn	11:00 AM	12:00 PM
	005es16831:_MS_Stn	11:00 AM	12:00 PM
	005es16885:_MS_Stn	11:00 AM	12:00 PM
15 of 31	005es16919:_MS_P_2	-	9:00 PM
	005es16919:_MSVP_1	11:00 AM	-

	005es16919:MMS_Stn	11:00 AM	12:00 PM
	005es16942:MMS_Stn	11:00 AM	12:00 PM
	005es16942:_MS_P_1	-	12:00 PM
	005es16944:_MN_P_1	11:00 AM	-
	005es16944:_MNHP_1	11:00 AM	-
	005es16977:MMN_Stn	11:00 AM	-
	005es16977:_MN_P_1	11:00 AM	-
	005es16990:MMS_Stn	11:00 AM	12:00 PM
	005es16990:_MS_P_1	-	12:00 PM
	005es16990:_MS_X_1	-	12:00 PM
	005es16990:_RS_O_1	-	12:00 PM
	005es17025:_MN_Stn	11:00 AM	-
	005es17025:_MN_X_1	11:00 AM	-
	005es17025:_MS_Stn	11:00 AM	-
16 of 31	005es17075:_MS_Stn	11:00 AM	12:00 PM
	005es17075:_MS_P_1	-	12:00 PM
	005es17076:_RNH_3	11:00 AM	-
	005es17076:_MN_P_1	11:00 AM	-
	005es17076:_MN_X_1	11:00 AM	-
	005es17131:_MN_Stn	11:00 AM	-
	005es17131:_MN_X_1	11:00 AM	-
	005es17131:MMS_Stn	11:00 AM	1:00 PM
	005es17131:_MS_P_2	-	9:00 PM
	005es17162:_MS_X_1	11:00 AM	-
	005es17162:_MS_Stn	11:00 AM	1:00 PM
	005es17163:MMN_Stn	11:00 AM	-
	005es17163:_MN_P_1	-	12:00 PM
	005es17163:_MNHP_1	11:00 AM	-
17 of 31	005es17215:_MS_Stn	11:00 AM	-
	005es17215:_MN_Stn	11:00 AM	-
	005es17264:_MN_Stn	11:00 AM	-
	005es17264:_CS_P_1	-	12:00 PM
	005es17264:_CSHP_2	11:00 AM	12:00 PM
	005es17288:_CS_P_1	11:00 AM	1:00 PM
	005es17288:_MMS_Stn	-	1:00 PM
	005es17288:_MSH_5	-	12:00 PM
	005es17288:_CS__1	11:00 AM	-
	005es17289:MMN_Stn	11:00 AM	-
	005es17289:_MNH_5	11:00 AM	-
	005es17289:_MN_P_2	11:00 AM	-
	005es17289:_MNHP_2	11:00 AM	-
	005es17328:_MN_Stn	11:00 AM	-
	005es17328:_MNH_6	11:00 AM	-
	005es17328:_MSH_5	-	12:00 PM
	005es17328:_MS_Stn	-	12:00 PM
	005es17375:_MN_Stn	11:00 AM	-

	005es17375:_MNH_5	11:00 AM	-
	005es17375:MMS_Stn	-	12:00 PM
	005es17375:_MSH_5	-	12:00 PM
	005es17375:_MS_P_1	-	12:00 PM
18 of 31	005es17416:_MN_Stn	11:00 AM	-
	005es17416:_MN_X_1	11:00 AM	-
	005es17416:_MS_Stn	11:00 AM	-
	005es17416:_MSH_5	-	12:00 PM
	005es17458:MMN_Stn	11:00 AM	-
	005es17458:_MNH_5	11:00 AM	-
	005es17458:_MN_P_2	11:00 AM	1:00 PM
	005es17458:_MNHP_1	11:00 AM	-
	005es17460:_MS_O_1	-	12:00 PM
	005es17460:_MS_Stn	-	12:00 PM
	005es17460:_MSH_4	-	12:00 PM
	005es17460:_MS_X_1	11:00 AM	-
	005es17460:_MS_X_2	11:00 AM	-
	005es17508:_MN_Stn	11:00 AM	-
	005es17508:_MNH_5	11:00 AM	-
	005es17508:_MS_Stn	-	12:00 PM
	005es17551:_MN_Stn	11:00 AM	-
	005es17551:_MNH_5	11:00 AM	-
	005es17551:_MS_P_2	5:00 AM	-
	005es17551:_MS_X_1	5:00 AM	-
	005es17601:_MSHP_2	-	12:00 PM
	005es17601:_MS_P_1	11:00 AM	12:00 PM
	005es17601:_MS_X_1	11:00 AM	-
	005es17627:MMN_Stn	11:00 AM	-
	005es17627:_MN_P_1	11:00 AM	-
	005es17627:_MN_P_2	11:00 AM	12:00 PM
	005es17627:_MNHP_2	11:00 AM	-
	005es17627:_MN_X_1	11:00 AM	-
19 of 31	005es17722:_MN_Stn	11:00 AM	-
	005es17722:_MNH_5	11:00 AM	-
	005es17774:_MN_Stn	11:00 AM	-
	005es17774:_MNH_4	11:00 AM	-
	005es17774:_CN_O_1	11:00 AM	12:00 PM
	005es17774:_CN_O_2	11:00 AM	12:00 PM
	005es17774:_CN_X_2	11:00 AM	-
	005es17774:_MSHP_3	-	12:00 PM
	005es17774:_MS_P_1	11:00 AM	1:00 PM
	005es17774:_MS_P_2	-	12:00 PM
	005es17774:_MS_X_1	11:00 AM	-
	005es17774:_MS_X_2	11:00 AM	-
	005es17775:_MS_P_1	-	12:00 PM
	005es17826:MMN_Stn	11:00 AM	-

	005es17826:_MNH_4	11:00 AM	-
	005es17826:_MN_P_1	11:00 AM	12:00 PM
	005es17826:_MN_P_2	11:00 AM	12:00 PM
	005es17826:_MN_X_1	11:00 AM	-
	005es17826:_MS_X_1	11:00 AM	-
	005es17875:_MNH_4	11:00 AM	-
	005es17926:_MS_P_1	11:00 AM	-
	005es17926:_MSHP_1	11:00 AM	12:00 PM
	005es17926:_MS_X_1	11:00 AM	-
	005es17927:MMN_Stn	11:00 AM	-
	005es17927:_MNH_4	11:00 AM	-
	005es17927:_MN_X_1	-	12:00 PM
	005es17927:_MN_P_1	11:00 AM	-
	005es17927:_MN_P_2	11:00 AM	1:00 PM
	005es17927:_MNHP_3	-	9:00 PM
	005es17976:_MN_Stn	11:00 AM	-
	005es17976:_MNH_5	11:00 AM	-
	005es17976:_MS_Stn	11:00 AM	-
20 of 31	005es18017:_MN_Stn	11:00 AM	-
	005es18017:_MNH_5	11:00 AM	-
	005es18017:_MS_Stn	11:00 AM	-
	005es18066:_MN_Stn	11:00 AM	-
	005es18066:_MNH_4	11:00 AM	-
	005es18066:_MN_X_1	11:00 AM	-
	005es18066:_MN_X_2	11:00 AM	-
	005es18066:_MNHX_1	11:00 AM	-
	005es18066:_MNHO_1	11:00 AM	-
	005es18066:MMS_Stn	11:00 AM	-
	005es18066:_MSHO_1	-	9:00 PM
	005es18066:_MS_P_1	11:00 AM	1:00 PM
	005es18106:_MS_P_1	11:00 AM	-
	005es18106:_MSHP_1	11:00 AM	-
	005es18115:_MN_Stn	11:00 AM	-
	005es18115:_MNHStn	11:00 AM	-
	005es18115:_MN_X_1	11:00 AM	12:00 PM
	005es18156:MMN_Stn	11:00 AM	-
	005es18156:_MNH_4	11:00 AM	-
	005es18156:_MN_P_1	11:00 AM	-
	005es18156:_MN_P_2	11:00 AM	-
	005es18156:_MS_X_1	11:00 AM	-
	005es18156:_MS_X_2	11:00 AM	-
	005es18170:_MMN_Stn	11:00 AM	-
	005es18170:_MNH_5	11:00 AM	-
	005es18170:_MN_P_1	11:00 AM	1:00 PM
	005es18170:_MN_P_2	11:00 AM	-
	005es18204:_MN_Stn	11:00 AM	-

	005es18204:_MNH_5	11:00 AM	-
	005es18204:_MN_X_1	11:00 AM	-
	005es18204:_MN_X_1	11:00 AM	-
	005es18204:_MS_O_2	11:00 AM	-
	005es18204:_CS_X_1	11:00 AM	-
	005es18211:_MSHP_1	-	1:00 PM
	005es18211:_MSHP_4	-	1:00 PM
	005es18211:_MS_P_2	11:00 AM	-
	005es18211:_MS_P_3	11:00 AM	-
	005es18264:_MN_Stn	11:00 AM	-
	005es18264:_MNH_4	11:00 AM	-
	005es18264:_MN_O_1	11:00 AM	-
	005es18264:_MN_O_2	11:00 AM	1:00 PM
	005es18264:_MS_X_1	11:00 AM	-
	005es18264:_MS_X_1	11:00 AM	-
21 of 31	005es18322:_MN_Stn	11:00 AM	-
	005es18322:_MNH_5	11:00 AM	-
	005es18382:_MS_P_3	-	12:00 PM
	005es18382:_MS_X_1	11:00 AM	-
	005es18406:MMN_Stn	11:00 AM	-
	005es18406:_MNHP_2	11:00 AM	-
	005es18406:_MNHP_4	11:00 AM	-
	005es18406:_MNH_4	11:00 AM	-
	005es18406:_MN_P_1	-	1:00 PM
	005es18406:_MN_P_3	11:00 AM	-
	005es18406:_MN_X_1	11:00 AM	-
	005es18406:_MN_X_2	11:00 AM	-
	005es18449:_MN_Stn	11:00 AM	-
	005es18449:_MNH_4	11:00 AM	-
	005es18449:_MS_Stn	11:00 AM	-
	005es18507:_MN_Stn	11:00 AM	-
	005es18507:_MNH_4	11:00 AM	-
	005es18507:_MS_Stn	11:00 AM	-
	005es18548:_MN_Stn	11:00 AM	-
	005es18548:_MNH_4	11:00 AM	-
	005es18548:_MS_Stn	11:00 AM	-
22 of 31	005es18577:_MN_Stn	11:00 AM	-
	005es18577:_MNH_4	11:00 AM	-
	005es18577:_MN_Stn	11:00 AM	-
	005es18635:MMS_Stn	11:00 AM	-
	005es18635:_MN_Stn	11:00 AM	-
	005es18635:_MNH_4	11:00 AM	-
	005es18635:_MN_X_1	11:00 AM	-
	005es18635:_MS_P_2	-	12:00 PM
	005es18635:_MS_X_1	11:00 AM	-
	005es18707:_MN_Stn	11:00 AM	-

	005es18707:_MNH_4	11:00 AM	-
	005es18707:_MS_Stn	11:00 AM	-
	005es18739:_MN_Stn	11:00 AM	-
	005es18739:_MNH_4	11:00 AM	-
	005es18739:_MS_Stn	11:00 AM	-
23 of 31	005es18789:_MS_Stn	11:00 AM	-
	005es18789:_MS_O_1	-	12:00 PM
	005es18789:_MS_O_2	-	12:00 PM
	005es18797:_MN_Stn	11:00 AM	-
	005es18797:_MNH_4	11:00 AM	-
	005es18846:_MN_Stn	11:00 AM	-
	005es18846:_MNH_5	11:00 AM	-
	005es18846:_MNH_6	11:00 AM	-
	005es18847:_MS_Stn	11:00 AM	-
	005es18900:_MN_Stn	11:00 AM	-
	005es18900:_MNH_4	11:00 AM	-
	005es18900:_MN_X_1	11:00 AM	-
	005es18900:_MN_X_3	-	1:00 PM
	005es18900:_MS_Stn	11:00 AM	-
	005es18931:_MN_P_1	11:00 AM	-
	005es18931:_MN_P_2	11:00 AM	1:00 PM
	005es18932:MMN_Stn	11:00 AM	-
	005es18932:_MNH_4	11:00 AM	-
	005es18932:_MN_P_1	11:00 AM	12:00 PM
	005es18944:_CSHO_2	11:00 AM	-
	005es18944:_CS_O_1	11:00 AM	-
	005es18944:_CS_O_3	11:00 AM	-
	005es18944:_CS_X_1	5:00 AM	1:00 PM
	005es18944:_CS_X_2	11:00 AM	-
	005es18944:_CS__1	11:00 AM	-
	005es18944:_MS_Stn	11:00 AM	-
	005es18944:_MSH_4	11:00 AM	-
	005es18998:_MN_Stn	11:00 AM	1:00 PM
	005es18998:_MNH_5	11:00 AM	-
	005es18998:_MS_Stn	11:00 AM	1:00 PM
	005es18998:_MSH_5	11:00 AM	-
	005es18998:_MS_X_1	5:00 AM	1:00 PM
	005es18998:_MS_X_2	11:00 AM	-
24 of 31	005es19040:_MN_Stn	11:00 AM	1:00 PM
	005es19040:_MNH_5	11:00 AM	-
	005es19040:_MS_Stn	11:00 AM	1:00 PM
	005es19040:_MSH_5	11:00 AM	-
	005es19090:_MN_Stn	11:00 AM	1:00 PM
	005es19090:_MNH_5	11:00 AM	-
	005es19090:_MS_Stn	11:00 AM	1:00 PM
	005es19090:_MSH_5	11:00 AM	-

	005es19139:_MN_Stn	11:00 AM	1:00 PM
	005es19139:_MNH_5	11:00 AM	-
	005es19139:_MS_Stn	11:00 AM	1:00 PM
	005es19139:_MSH_5	11:00 AM	-
25 of 31	005es19188:_MN_Stn	11:00 AM	1:00 PM
	005es19188:_MNH_5	11:00 AM	-
	005es19188:_MS_Stn	11:00 AM	1:00 PM
	005es19188:_MSH_6	11:00 AM	-
	005es19226:MMS_Stn	11:00 AM	1:00 PM
	005es19226:_MSH_6	11:00 AM	-
	005es19226:_MS_P_1	11:00 AM	-
	005es19226:_MS_P_2	11:00 AM	-
	005es19229:_MN_Stn	11:00 AM	1:00 PM
	005es19229:_MNH_4	11:00 AM	-
	005es19229:_MN_X_1	11:00 AM	-
	005es19229:_MNHX_2	11:00 AM	-
	005es19229:_MSHO_1	11:00 AM	-
	005es19255:MMS_Stn	-	1:00 PM
	005es19255:_MSH_5	11:00 AM	-
	005es19255:_MS_P_1	11:00 AM	-
	005es19255:_MS_P_2	11:00 AM	-
	005es19277:MMN_Stn	11:00 AM	1:00 PM
	005es19277:_MNH_4	11:00 AM	-
	005es19277:_MN_P_1	11:00 AM	-
	005es19277:_MN_P_2	11:00 AM	12:00 PM
	005es19303:_MN_Stn	11:00 AM	1:00 PM
	005es19303:_MNH_5	11:00 AM	-
	005es19303:_MS_Stn	-	1:00 PM
	005es19303:_MSH_5	11:00 AM	-
	005es19352:_MN_Stn	11:00 AM	1:00 PM
	005es19352:_MNH_5	11:00 AM	-
	005es19352:_MN_X_1	-	12:00 PM
	005es19352:MMS_Stn	-	1:00 PM
	005es19352:_MSH_5	11:00 AM	-
	005es19352:_MS_P_1	11:00 AM	-
	005es19352:_MS_P_2	11:00 AM	-
26 of 31	005es19388:_MN_Stn	11:00 AM	1:00 PM
	005es19388:_MNH_4	11:00 AM	-
	005es19388:_MN_X_1	11:00 AM	-
	005es19388:_MS_Stn	-	1:00 PM
	005es19388:_MSH_4	11:00 AM	-
	005es19388:_MS_O_1	-	1:00 PM
	005es19416:MMN_Stn	11:00 AM	-
	005es19416:_MN_P_1	11:00 AM	-
	005es19416:_MN_P_2	11:00 AM	-
	005es19416:_MS_Stn	-	1:00 PM

	005es19416:_MSH_4	11:00 AM	-
	005es19416:_MS_X_1	-	12:00 PM
	005es19416:_MS_X_2	11:00 AM	-
	005es19417:_MN_P_1	11:00 AM	12:00 PM
	005es19469:_MN_Stn	11:00 AM	-
	005es19469:_MN_X_1	-	12:00 PM
	005es19469:MMS_Stn	11:00 AM	1:00 PM
	005es19469:_MS_P_1	11:00 AM	-
27 of 31	005es19843:_MN_Stn	11:00 AM	-
	005es19843:_MN_O_1	11:00 AM	-
	005es19843:_MS_Stn	11:00 AM	1:00 PM
	005es19900:_MN_Stn	11:00 AM	-
	005es19900:_MN_X_1	11:00 AM	-
	005es19900:_MN_X_2	11:00 AM	-
	005es19900:_MS_Stn	11:00 AM	1:00 PM
	005es19900:_MS_O_1	-	1:00 PM
	005es19900:_MS_O_2	-	1:00 PM
	005es19928:_MN_Stn	11:00 AM	-
	005es19928:_MS_X_1	11:00 AM	-
	005es19968:_MN_Stn	11:00 AM	-
	005es19968:_MS_Stn	11:00 AM	1:00 PM
	005es20020:_MN_Stn	11:00 AM	-
	005es20020:_MS_Stn	11:00 AM	1:00 PM
28 of 31	005es20066:_MN_Stn	11:00 AM	-
	005es20066:_MN_X_1	11:00 AM	-
	005es20066:_MN_X_2	11:00 AM	12:00 PM
	005es20066:MMS_Stn	11:00 AM	1:00 PM
	005es20066:_MS_P_1	12:00 AM	8:00 PM
	005es20066:_MS_P_2	-	1:00 PM
	005es20088:_MN_Stn	11:00 AM	-
	005es20088:_MS_Stn	11:00 AM	1:00 PM
	005es20088:_MS_X_1	11:00 AM	12:00 PM
	005es20137:_MN_Stn	11:00 AM	-
	005es20137:_MS_Stn	11:00 AM	1:00 PM
	005es20182:_MN_Stn	11:00 AM	-
	005es20182:_MS_Stn	11:00 AM	1:00 PM
	005es20234:_MN_Stn	11:00 AM	-
	005es20234:_MN_X_1	11:00 AM	-
	005es20234:MMS_Stn	11:00 AM	1:00 PM
	005es20234:_MS_P_1	-	1:00 PM
	005es20234:_MS_P_2	-	1:00 PM
	005es20259:_MN_Stn	11:00 AM	-
	005es20259:_MN_O_1	11:00 AM	-
	005es20259:_MS_Stn	11:00 AM	1:00 PM
	005es20259:_MS_X_1	11:00 AM	1:00 PM
29 of 31	005es20313:_MN_Stn	11:00 AM	-

		005es20313:_MS_Stn	11:00 AM	1:00 PM
		005es20369:_MN_Stn	11:00 AM	-
		005es20369:_MS_Stn	11:00 AM	1:00 PM
		005es20424:_MN_Stn	11:00 AM	-
		005es20424:_MS_Stn	11:00 AM	1:00 PM
		005es20478:_MN_Stn	11:00 AM	-
		005es20478:_MS_Stn	11:00 AM	1:00 PM
		005es20533:_MN_Stn	11:00 AM	-
		005es20533:_MS_Stn	11:00 AM	1:00 PM
	30 of 31	005es20587:_MN_Stn	11:00 AM	-
		005es20587:_MN_X_1	11:00 AM	-
		005es20587:_MN_X_2	11:00 AM	-
		005es20587:_MN_O_1	11:00 AM	-
		005es20587:MMS_Stn	11:00 AM	1:00 PM
		005es20587:_MS_P_1	11:00 AM	1:00 PM
		005es20607:_MS_P_1	-	1:00 PM
		005es20607:_MS_X_1	11:00 AM	12:00 PM
		005es20667:_MN_Stn	11:00 AM	-
		005es20667:_MS_Stn	11:00 AM	1:00 PM
		005es20720:_MN_Stn	11:00 AM	-
		005es20720:_MN_X_1	11:00 AM	12:00 PM
		005es20720:_MS_Stn	11:00 AM	-
		005es20720:_MS_O_1	-	12:00 PM
		005es20778:_MN_Stn	11:00 AM	-
		005es20778:_MS_Stn	11:00 AM	-
	31 of 31	005es20820:_MN_Stn	11:00 AM	-
		005es20820:_MS_Stn	11:00 AM	-
		005es20855:_MN_Stn	11:00 AM	-
		005es20855:_MN_X_1	11:00 AM	-
		005es20855:_MS_Stn	11:00 AM	-
		005es20855:_MS_O_1	11:00 AM	12:00 PM
		005es20877:_MN_Stn	11:00 AM	-
		005es20877:_MN_O_1	11:00 AM	-
		005es20877:_MS_Stn	11:00 AM	-
		005es20933:_MN_Stn	11:00 AM	-
		005es20933:_MS_Stn	11:00 AM	-
		005es21029:_MN_Stn	11:00 AM	-
		005es21029:_MN_X_1	11:00 AM	-
		005es21029:_MS_Stn	11:00 AM	-
		005es21029:_MS_O_1	11:00 AM	-
I-90	1 of 11	090es00261:_MW_O_1	11:00 AM	12:00 PM
		090es00262:_ME_P_2	11:00 AM	-
		090es00259:_ME_P_1	11:00 AM	1:00 PM
	2 of 11	090es00302:_ME_X_1	11:00 AM	-
		090es00341:_ME_P_2	11:00 AM	-
		090es00353:_MW_X_2	11:00 AM	-

	090es00359:_MEH_4	11:00 AM	-
	090es00430:_MEH_4	11:00 AM	-
	090es00454:_MEH_4	11:00 AM	-
3 of 11	090es00502:_MEH_4	11:00 AM	-
	090es00595:_ME_X_1	11:00 AM	-
	090es00667:_ME_X_1	11:00 AM	-
	090es00667:_MEH_4	11:00 AM	-
	090es00667:_MW_P_2	11:00 AM	-
4 of 11	696es00696:_MEH_4	11:00 AM	-
	090es00720:_MWHX_2	11:00 AM	-
	090es00720:_MW_X_1	11:00 AM	12:00 PM
	090es00720:_ME_P_1	11:00 AM	-
	090es00720:_ME_P_2	11:00 AM	12:00 PM
	090es00720:_MEH_4	11:00 AM	-
	090es00720_MEHO_1	11:00 AM	-
	090es00720:_ME_P_2	11:00 AM	-
	090es00769:_MEH_4	11:00 AM	-
	090es00838:_MEH_4	11:00 AM	-
5 of 11	090es00893:_ME_Stn	11:00 AM	-
	090es00893:_MEHX_2	11:00 AM	-
	090es00912:_ME_O_1	11:00 AM	-
	090es00912:_MW_P_1	11:00 AM	-
	090es00912:_MW_P_2	11:00 AM	-
	090es00961:_MEH_5	11:00 AM	-
	090es00961:_CE_X_1	11:00 AM	-
	090es00961:_CW_2	-	12:00 PM
	090es00996:_ME_Stn	11:00 AM	-
	090es00996:_MW_P_2	11:00 AM	-
	090es00996:_MWHP_2	-	12:00 PM
	090es00996:_MW_X_1	11:00 AM	12:00 PM
	090es00996:_MW_X_2	11:00 AM	12:00 PM
	090es01040:_MEH_6	11:00 AM	-
	090es01040:_ME_Stn	11:00 AM	-
	090es01040:_MW_Stn	11:00 AM	-
6 of 11	090es01090:_MEH_6	11:00 AM	-
	090es01090:_MW_Stn	11:00 AM	-
	090es01143:_ME_Stn	11:00 AM	-
	090es01143:_MEH_4	11:00 AM	-
	090es01143:_CE__1	-	12:00 PM
	090es01143:_CE_O_1	11:00 AM	-
	090es01143:_MW_P_1	11:00 AM	12:00 PM
	090es01143:_MW_P_2	11:00 AM	-
	090es01143:_MW_O_1	11:00 AM	-
	090es01143:_CW_O_1	11:00 AM	-
	090es01143:_CW_O_2	11:00 AM	-
	090es01181:MME_Stn	11:00 AM	-

	090es01181:_MEH_4	11:00 AM	-
	090es01181:_ME_P_1	11:00 AM	-
	090es01181:_ME_P_2	11:00 AM	-
	090es01181:_CE_X_1	11:00 AM	-
7 of 11	090es01243:_ME_Stn	11:00 AM	-
	090es01243:_MEH_5	11:00 AM	-
	090es01289:_ME_Stn	11:00 AM	-
	090es01289:_MEH_5	11:00 AM	-
	090es01289:_MWH_5	11:00 AM	-
	090es01341:_ME_Stn	11:00 AM	-
	090es01341:_MEH_4	11:00 AM	-
	090es01341:_ME_X_1	11:00 AM	-
	090es01341:_MWH_4	11:00 AM	-
	090es01341:_MW_P_2	-	12:00 PM
	090es01397:_ME_Stn	11:00 AM	-
	090es01397:_MEH_4	11:00 AM	-
	090es01397:_MWH_4	11:00 AM	-
	090es01467:_ME_Stn	11:00 AM	-
	090es01467:_MEH_4	11:00 AM	-
	090es01467:_MWH_4	11:00 AM	-
8 of 11	090es01513:_ME_Stn	11:00 AM	-
	090es01577:_ME_Stn	10:00 AM	-
	090es01577:_ME_X_3	11:00 AM	-
	090es01577:_ME_X_4	11:00 AM	-
	090es01577:_MW_P_1	11:00 AM	-
	090es01577:_MW_P_2	11:00 AM	-
	090es01577:_MW_P_3	-	12:00 PM
	090es01577:_MW_X_1	11:00 AM	12:00 PM
	090es01577:_MWH_P_3	11:00 AM	-
	090es01635:_ME_Stn	11:00 AM	-
	090es01696:_ME_Stn	11:00 AM	-
	090es01696:_ME_X_1	11:00 AM	-
	090es01696:_MW_X_1	11:00 AM	12:00 PM
	090es01748:_ME_Stn	11:00 AM	-
	090es01748:_ME_O_1	11:00 AM	-
	090es01748:_MW_Stn	11:00 AM	-
	090es01790:_ME_Stn	11:00 AM	-
	090es01790:_ME_X_1	11:00 AM	-
	090es01790:_ME_X_2	11:00 AM	-
	090es01790:_ME_O_1	11:00 AM	-
	090es01790:_MW_X_1	11:00 AM	-
	090es01790:_MMW_Stn	11:00 AM	-
9 of 11	090es01864:_MW_Stn	11:00 AM	-
	090es01880:_ME_Stn	11:00 AM	-
	090es01941:_MW_Stn	11:00 AM	-
	090es01941:_ME_Stn	11:00 AM	-

	10 of 11	090es02481:_ME_Stn	11:00 AM	-
		090es02554_MMW_Stn	11:00 AM	-
I-405	1 of 16	405es00011:_MN__1	11:00 AM	1:00 PM
		405es00011:_MNH0_1	11:00 AM	-
		405es00011:_MN_O_1	11:00 AM	-
		405es00011:_MN_O_2	11:00 AM	1:00 PM
		405es00011:_MS_X_2	11:00 AM	1:00 PM
		405es00044:_MN_Stn	11:00 AM	1:00 PM
		405es00044:_MNH__4	11:00 AM	-
		405es00044:_MN_O_1	11:00 AM	-
		405es00044:_MS_Stn	-	1:00 PM
		405es00044:_MS_X_1	11:00 AM	12:00 PM
		405es00086:MMS_Stn	-	1:00 PM
		405es00086:_MS_P_1	11:00 AM	-
		405es00086:_MS_P_2	11:00 AM	-
		405es00086:_MS_X_1	11:00 AM	-
		405es00092:MMN_Stn	11:00 AM	1:00 PM
		405es00092:_MNH__4	11:00 AM	-
		405es00092:_MN_P_1	11:00 AM	-
		405es00092:_MN_P_2	11:00 AM	-
		405es00139:_MN_Stn	11:00 AM	-
		405es00139:_MNH__4	11:00 AM	-
		405es00139:_MS_Stn	11:00 AM	1:00 PM
	2 of 16	405es00171:_MN_Stn	11:00 AM	-
		405es00171:_MNH__4	11:00 AM	-
		405es00171:_MS_Stn	11:00 AM	1:00 PM
		405es00221:_MN_Stn	11:00 AM	-
		405es00221:_MNH__3	11:00 AM	-
		405es00221:_CN_X_1	11:00 AM	1:00 PM
		405es00221:MMS_Stn	-	1:00 PM
		405es00221:_MS_P_1	-	1:00 PM
		405es00221:_MS_P_2	11:00 AM	1:00 PM
		405es00221:_MS_O_1	5:00 AM	1:00 PM
		405es00221:_MS_X_1	11:00 AM	12:00 PM
		405es00221:_MS_X_2	11:00 AM	-
		405es00221:_MSH__4	11:00 AM	-
		405es00268:MMN_Stn	11:00 AM	-
		405es00268:_MNH__3	11:00 AM	-
		405es00268:_MNH0_2	5:00 AM	-
		405es00268:_MN_O_1	11:00 AM	-
		405es00268:_MN_P_1	11:00 AM	-
		405es00268:_MN_P_2	5:00 AM	12:00 PM
		405es00268:_MS_Stn	-	1:00 PM
		405es00268:_MSH__3	11:00 AM	1:00 PM
		405es00268:_MSHX_2	11:00 AM	-
		405es00294:MMN_Stn	11:00 AM	-

	405es00294: _MNH_ 4	11:00 AM	-
	405es00294: _MN_P_ 1	5:00 AM	-
	405es00294: _MN_P_ 2	11:00 AM	12:00 PM
	405es00294: _MS_Stn	11:00 AM	1:00 PM
	405es00294: _MSH_ 4	11:00 AM	-
	405es00342: _MN_Stn	11:00 AM	-
	405es00342: _MS_Stn	11:00 AM	-
	405es00342: _MSH_ 4	11:00 AM	-
	405es00342: _MS_X_ 1	11:00 AM	-
3 of 16	405es00391: _MN_Stn	11:00 AM	-
	405es00391: _MN_X_ 1	11:00 AM	-
	405es00391: _MN_X_ 2	11:00 AM	1:00 PM
	405es00391:MMS_Stn	11:00 AM	-
	405es00391: _MSH_ 3	11:00 AM	-
	405es00391: _MS_P_ 2	-	1:00 PM
	405es00391: _MSHP_ 2	-	1:00 PM
	405es00412:MMN_Stn	11:00 AM	-
	405es00412: _MN_P_ 1	-	12:00 PM
	405es00473:MMN_Stn	11:00 AM	-
	405es00473: _MS_Stn	11:00 AM	-
	405es00473: _MSH_ 3	11:00 AM	-
	405es00473: _MS_X_ 1	11:00 AM	-
	405es00532:MMS_Stn	11:00 AM	12:00 PM
	405es00532: _MSH_ 3	11:00 AM	-
	405es00532: _MSHP_ 1	11:00 AM	-
	405es00532: _MS_P_ 1	11:00 AM	1:00 PM
	405es00532: _MS_X_ 1	11:00 AM	1:00 PM
	405es00532: _MS_X_ 2	11:00 AM	-
	405es00536:MMN_Stn	11:00 AM	-
	405es00536: _MN_P_ 1	11:00 AM	-
	405es00536: _MN_X_ 1	11:00 AM	-
	405es00608: _MN_Stn	11:00 AM	-
	405es00608: _MNH_ 3	11:00 AM	-
	405es00608: _MS_Stn	11:00 AM	12:00 PM
	405es00608: _MSH_ 3	11:00 AM	-
4 of 16	405es00646:MMS_Stn	11:00 AM	12:00 PM
	405es00646: _MSH_ 3	11:00 AM	-
	405es00646: _MS_X_ 1	11:00 AM	-
	405es00656:MMN_Stn	11:00 AM	-
	405es00656: _MN_P_ 1	-	12:00 PM
	405es00656: _MN_X_ 1	11:00 AM	-
	405es00700: _MN_Stn	11:00 AM	-
	405es00700: _MS_Stn	11:00 AM	-
	405es00700: _MSH_ 3	11:00 AM	-
	405es00740:MMS_Stn	11:00 AM	12:00 PM
	405es00740: _MSH_ 3	11:00 AM	-

	405es00740:_MSHP_1	11:00 AM	-
	405es00740:_MS_X_1	11:00 AM	-
	405es00745:MMN_Stn	11:00 AM	12:00 PM
	405es00745:_MN_P_1	-	12:00 PM
	405es00745:_MN_P_2	-	12:00 PM
	405es00803:_MN_Stn	11:00 AM	12:00 PM
	405es00803:_MNH__3	-	12:00 PM
	405es00803:_MS_Stn	11:00 AM	12:00 PM
	405es00803:_MSH__3	11:00 AM	-
	405es00840:_MN_Stn	11:00 AM	-
	405es00840:_MS_Stn	11:00 AM	12:00 PM
	405es00840:_MSH__3	11:00 AM	-
5 of 16	405es00890:_MN_Stn	11:00 AM	12:00 PM
	405es00890:_MNH__3	11:00 AM	12:00 PM
	405es00890:_MS_Stn	11:00 AM	12:00 PM
	405es00890:_MSH__3	11:00 AM	-
	405es00921:_MN_X_1	11:00 AM	-
	405es00921:MMS_Stn	11:00 AM	12:00 PM
	405es00921:_MSH__3	11:00 AM	-
	405es00921:_MS_P_2	-	12:00 PM
	405es00936:MMN_Stn	11:00 AM	-
	405es00936:_MS_X_1	11:00 AM	-
	405es00975:_MS_Stn	11:00 AM	12:00 PM
	405es00975:_MSH__3	11:00 AM	-
	405es01013:_MN_O_1	-	12:00 PM
	405es01013:_MN_X_1	11:00 AM	-
	405es01013:MMS_Stn	11:00 AM	12:00 PM
	405es01013:_MSH__3	11:00 AM	-
	405es01013:_MS_P_1	11:00 AM	-
	405es01013:_MS_P_2	11:00 AM	-
6 of 16	405es01079:_MN_X_1	11:00 AM	-
	405es01079:_MN_X_2	-	12:00 PM
	405es01079:_MS_Stn	11:00 AM	12:00 PM
	405es01079:_MSH__3	11:00 AM	-
	405es01079:_MS_O_1	11:00 AM	-
	405es01079:_MS_O_2	11:00 AM	12:00 PM
	405es01128:_MS_Stn	11:00 AM	12:00 PM
	405es01128:_MSH__3	11:00 AM	-
	405es01178:_MN_Stn	11:00 AM	-
	405es01178:_MS_Stn	11:00 AM	12:00 PM
	405es01178:_MSH__1	11:00 AM	-
	405es01178:_MSH__6	11:00 AM	-
	405es01228:_MN_Stn	11:00 AM	-
	405es01229:_MS_Stn	11:00 AM	12:00 PM
	405es01229:_MSH__1	11:00 AM	-
	405es01229:_MSH__6	11:00 AM	-

7 of 16	405es01272:MMS_Stn	11:00 AM	12:00 PM
	405es01272:_MSH__5	11:00 AM	-
	405es01272:_MS_P_1	11:00 AM	-
	405es01272:_MSHP_1	11:00 AM	-
	405es01290:MMN_Stn	11:00 AM	-
	405es01290:_MN_P_2	11:00 AM	-
	405es01290:_MN_X_2	-	12:00 PM
	405es01331:_MN_Stn	11:00 AM	-
	405es01331:_MNH__4	11:00 AM	-
8 of 16	405es01333:MMS_Stn	11:00 AM	12:00 PM
	405es01333:_MSH__4	11:00 AM	-
	405es01333:_MS_P_1	11:00 AM	-
	405es01333:_MS_P_2	11:00 AM	1:00 PM
	405es01333:_MS_P_3	11:00 AM	-
	405es01333:_MSHP_4	11:00 AM	-
	405es01333:_CS_O_1	11:00 AM	1:00 PM
	405es01333:_MS_X_1	-	12:00 PM
	405es01333:_CS_X_1	11:00 AM	12:00 PM
	405es01333:_CS_X_2	-	12:00 PM
	405es01333:_CS_X_3	-	1:00 PM
	405es01333:_MSRA_1	11:00 AM	-
	405es01333:_MSRA_2	11:00 AM	1:00 PM
	405es01360:MMN_Stn	11:00 AM	-
	405es01360:_MNH__4	11:00 AM	-
	405es01360:_MN_P_1	11:00 AM	-
	405es01360:_MN_P_2	11:00 AM	-
	405es01360:_MN_X_1	11:00 AM	12:00 PM
	405es01360:_MN_X_2	11:00 AM	12:00 PM
	405es01360:_MSHO__1	11:00 AM	-
	405es01392:_MN_Stn	11:00 AM	-
	405es01392:_MNHStn	11:00 AM	-
	405es01392:_MNHO__1	11:00 AM	-
	405es01392:_CN_O_1	11:00 AM	-
	405es01392:_CN_O_2	11:00 AM	-
	405es01392:_DCN__1	11:00 AM	-
	405es01392:_CN_X_1	11:00 AM	12:00 PM
	405es01392:_CN__1	-	12:00 PM
	405es01392:_MS_Stn	11:00 AM	12:00 PM
	405es01392:_CS_X_3	-	1:00 PM
9 of 16	405es01427:_MN_Stn	11:00 AM	-
	405es01427:_MNH_Stn	11:00 AM	-
	405es01427:_MS_Stn	11:00 AM	12:00 PM
	405es01463:MMN_Stn	11:00 AM	-
	405es01463:_MNHStn	11:00 AM	-
	405es01463:_MN_P_1	11:00 AM	-
	405es01463:_MN_P_2	11:00 AM	-

	405es01463:_MNHP_2	11:00 AM	-
	405es01463:_MN_M_1	11:00 AM	-
	405es01465:_MS_Stn	11:00 AM	12:00 PM
	405es01508:_MN_Stn	11:00 AM	-
	405es01508:_MNHStn	11:00 AM	-
	405es01508:_MN_O_1	11:00 AM	-
	405es01508:_MN_O_2	11:00 AM	-
	405es01508:_MS_X_2	-	12:00 PM
	405es01563:_MN_Stn	11:00 AM	-
	405es01563:_MNHStn	11:00 AM	-
	405es01563:_MS_Stn	11:00 AM	12:00 PM
	405es01612:_MN_Stn	11:00 AM	-
	405es01612:_MNHStn	11:00 AM	-
	405es01612:_MS_Stn	11:00 AM	12:00 PM
10 of 16	405es01667:_MN_Stn	11:00 AM	1:00 PM
	405es01667:_MS_Stn	11:00 AM	12:00 PM
	405es01723:_MN_Stn	11:00 AM	1:00 PM
	405es01723:_MNHStn	11:00 AM	-
	405es01723:MMS_Stn	11:00 AM	12:00 PM
	405es01723:_MS_P_1	11:00 AM	12:00 PM
	405es01749:MMN_Stn	11:00 AM	1:00 PM
	405es01749:_MNHStn	11:00 AM	-
	405es01749:_MN_P_1	11:00 AM	12:00 PM
	405es01749:_MN_P_2	11:00 AM	-
	405es01749:_MNHP_1	11:00 AM	-
	405es01749:_MS_Stn	11:00 AM	12:00 PM
11 of 16	405es01799:_MN_Stn	11:00 AM	1:00 PM
	405es01799:_MNHStn	11:00 AM	-
	405es01799:_CN_X_1	-	12:00 PM
	405es01799:_CN__1	-	12:00 PM
	405es01799:MMS_Stn	11:00 AM	12:00 PM
	405es01799:_CS_P_1	11:00 AM	12:00 PM
	405es01799:_CS_P_2	11:00 AM	-
	405es01799:_CS__1	11:00 AM	12:00 PM
	405es01799:_CSHP_2	11:00 AM	-
	405es01823:MMN_Stn	11:00 AM	1:00 PM
	405es01823:_MNHStn	11:00 AM	-
	405es01823:_CN_P_1	11:00 AM	-
	405es01823:_CN_P_2	11:00 AM	12:00 PM
	405es01823:_CNHP_2	11:00 AM	-
	405es01823:_CN__1	11:00 AM	-
	405es01823:_CN_X_1	-	12:00 PM
	405es01823:_MS_Stn	11:00 AM	12:00 PM
	405es01823:_CS_X_1	11:00 AM	-
	405es01870:_MN_Stn	11:00 AM	1:00 PM
	405es01870:_MNHStn	11:00 AM	-

	405es01870:_MS_Stn	11:00 AM	12:00 PM
	405es01921:_MN_Stn	11:00 AM	-
	405es01921:_MNHStn	11:00 AM	-
	405es01921:_MS_Stn	11:00 AM	12:00 PM
12 of 16	405es01971:_MN_Stn	11:00 AM	-
	405es01971:_MNHStn	11:00 AM	-
	405es01971:_MN_X_1	11:00 AM	12:00 PM
	405es01972:MMS_Stn	11:00 AM	12:00 PM
	405es01972:_MSHP_2	-	12:00 PM
	405es01972:_MS_P_1	11:00 AM	12:00 PM
	405es01972:_MS_P_2	11:00 AM	-
	405es02022:_MN_Stn	11:00 AM	-
	405es02022:_MNHStn	11:00 AM	-
	405es02022:MMS_Stn	11:00 AM	12:00 PM
	405es02022:_MS_P_1	11:00 AM	-
	405es02022:_MS_P_2	-	12:00 PM
	405es02022:_MS_P_3	11:00 AM	-
	405es02022:_MSHP_2	-	12:00 PM
	405es02047:MMN_Stn	11:00 AM	-
	405es02047:_MNHStn	11:00 AM	-
	405es02047:_MN_P_1	11:00 AM	-
	405es02047:_MN_P_2	11:00 AM	-
	405es02047:_MN_P_3	11:00 AM	1:00 PM
	405es02047:_MN_X_1	11:00 AM	1:00 PM
	405es02047:_MN_X_2	11:00 AM	-
	405es02047:_MNHX_3	11:00 AM	-
	405es02047:_MS_Stn	11:00 AM	12:00 PM
	405es02047:_MS_X_1	11:00 AM	-
13 of 16	405es02093:_MN_Stn	11:00 AM	-
	405es02093:_MNHStn	11:00 AM	-
	405es02093:_MNH_6	11:00 AM	-
	405es02093:_MS_Stn	-	12:00 PM
	405es02093:_MSHX_1	-	1:00 PM
	405es02136:_MN_Stn	11:00 AM	-
	405es02136:_MNHStn	11:00 AM	-
	405es02136:_MS_Stn	11:00 AM	12:00 PM
	405es02183:_MN_Stn	11:00 AM	-
	405es02183:_MNH_5	11:00 AM	-
	405es02183:_MS_Stn	-	12:00 PM
	405es02231:_MN_Stn	11:00 AM	-
	405es02231:_MNH_5	11:00 AM	-
	405es02231:MMS_Stn	11:00 AM	12:00 PM
	405es02231:_MS_P_1	-	12:00 PM
	405es02273:_MN_X_1	11:00 AM	1:00 PM
	405es02273:_MN_X_2	11:00 AM	-
	405es02273:_MS_Stn	-	12:00 PM

	405es02273:_MS_X_2	11:00 AM	-
	405es02273:_MSBX_1	11:00 AM	-
	405es02301:MMN_Stn	11:00 AM	-
	405es02301:_MNH_3	11:00 AM	-
	405es02301:_CN_O_1	11:00 AM	-
	405es02301:_MNHP_2	11:00 AM	-
	405es02301:_MN_X_1	11:00 AM	-
14 of 16	405es02351:_MN_Stn	11:00 AM	-
	405es02351:_MNH_3	11:00 AM	-
	405es02351:_CN_X_1	11:00 AM	-
	405es02351:_CN_X_2	11:00 AM	-
	405es02351:MMS_Stn	11:00 AM	-
	405es02351:_MS_P_1	5:00 AM	-
	405es02369:MMN_Stn	11:00 AM	-
	405es02369:_MNH_3	11:00 AM	-
	405es02369:_MS_X_1	11:00 AM	-
	405es02393:_MN_Stn	11:00 AM	-
	405es02393:_CN_O_1	11:00 AM	-
	405es02393:_MS_Stn	11:00 AM	-
	405es02439:_MN_Stn	11:00 AM	-
	405es02439:_MNH_3	11:00 AM	-
	405es02439:MMS_Stn	11:00 AM	-
	405es02439:_MS_P_1	11:00 AM	-
	405es02439:_MS_P_2	11:00 AM	12:00 PM
	405es02465:MMN_Stn	11:00 AM	-
	405es02465:_MNH_3	11:00 AM	-
	405es02465:_MN_P_1	11:00 AM	-
	405es02465:_MNHP_1	11:00 AM	-
	405es02465:_MS_Stn	11:00 AM	-
	405es02468:_MN_P_1	11:00 AM	12:00 PM
15 of 16	405es02517:_MN_Stn	11:00 AM	-
	405es02517:_MNH_4	11:00 AM	-
	405es02517:_MS_Stn	11:00 AM	-
	405es02556:_MS_Stn	11:00 AM	-
	405es02568:_MN_Stn	11:00 AM	-
	405es02568:_MNH_4	11:00 AM	-
	405es02616:_MN_Stn	11:00 AM	-
	405es02616:_MNH_4	11:00 AM	-
	405es02616:_MS_Stn	11:00 AM	-
	405es02662:_MN_Stn	11:00 AM	-
	405es02662:_MNH_3	11:00 AM	-
	405es02662:MMS_Stn	11:00 AM	-
	405es02662:_MS_P_1	11:00 AM	12:00 PM
	405es02663:_MS_P_1	-	12:00 PM
	405es02663:_MS_P_2	11:00 AM	12:00 PM
	405es02662:_MSHP_1	-	1:00 PM

		405es02687:_MNHP_1 405es02688:MMN_Stn 405es02688:_MNH_3 405es02688:_MNHP_1 405es02688:_MS_Stn 405es02744:_MN_Stn 405es02744:_MNH_3 405es02744:_MS_Stn	11:00 AM 11:00 AM 11:00 AM 11:00 AM 11:00 AM 11:00 AM 11:00 AM 11:00 AM	1:00 PM - - - - 1:00 PM - -
	16 of 16	405es02796:_MN_Stn 405es02796:_MNH_3 405es02796:_MS_Stn 405es02853:_MN_Stn 405es02853:_MNH_3 405es02853:_MS_Stn 405es02898:_MN_Stn 405es02898:_MNH_3 405es02898:_MS_Stn 405es02953:_MN_Stn 405es02953:_MNH_4 405es02953:_MS_Stn 405es03006:_MN_Stn	11:00 AM 11:00 AM 11:00 AM 11:00 AM 11:00 AM 11:00 AM 11:00 AM 11:00 AM 11:00 AM 11:00 AM 11:00 AM 11:00 AM 11:00 AM	1:00 PM - - 1:00 PM - - 1:00 PM - - - - - -
SR 18	1 of 7	018es00020:_MW_Stn 018es00020:_ME_0_1 018es00020:_ME_Stn 018es00062:_MW_Stn 018es00062:_MW_X_1 018es00062:_MW_X_2 018es00062:_ME_X_1 018es00062:_ME_Stn 018es00092:_MW_Stn 018es00092:MME_Stn 018es00092:_MEHP_1	11:00 AM 11:00 AM 11:00 AM 11:00 AM 11:00 AM 11:00 AM 11:00 AM 11:00 AM 11:00 AM 11:00 AM 11:00 AM	- 1:00 PM - - - 1:00 PM - - - - - -
	2 of 7	018es00147:_MW_Stn 018es00185:_MW_Stn 018es00147:_ME_Stn 018es00185:_ME_Stn 018es00253:_MW_Stn 018es00253:_ME_X_1 018es00253:_ME_Stn 018es00295:_MW_X_1	11:00 AM 11:00 AM 11:00 AM 11:00 AM 11:00 AM 11:00 AM 11:00 AM 11:00 AM	- - 1:00 PM 1:00 PM - 1:00 PM - 1:00 PM
	3 of 7	018es00366:MMW_Stn 018es00366:_ME_Stn 018es00366:_ME_X_1 018es00366:_MW_P_1 018es00366:_MW_P_2 018es00409:MMW_Stn	11:00 AM 11:00 AM 11:00 AM 11:00 AM - 11:00 AM	- - - - 1:00 PM -

		018es00409:_MW_P_1	11:00 AM	-
		018es00425:_MW_X_1	11:00 AM	-
		018es00523:_ME_Stn	11:00 AM	-
		018es00523:_MW_Stn	11:00 AM	-
	5 of 7	018es01257:_MW_Stn	11:00 AM	-
		018es01363:_MW_Stn	11:00 AM	-
	6 of 7	018es01500:_MW_Stn	11:00 AM	-
		018es01581:_ME_Stn	-	12:00 PM
		018es01581:_MW_Stn	11:00 AM	-
		018es01581:_MW_X_1	11:00 AM	-
		018es01634:_ME_Stn	-	12:00 PM
		018es01634:_MW_Stn	11:00 AM	-
		018es01678:_ME_Stn	-	12:00 PM
		018es01678:_MW_Stn	11:00 AM	-
		018es01744:_ME_Stn	-	12:00 PM
		018es01744:_MW_Stn	11:00 AM	-
	7 of 7	018es01779:_ME_Stn	-	12:00 PM
		018es01779:_ME_X_1	11:00 AM	-
		018es01779:_MW_Stn	11:00 AM	-
		018es01779:_MW_X_1	11:00 AM	-
		018es01829:_ME_O_1	-	12:00 PM
		018es01829:_ME_Stn	-	12:00 PM
		018es01829:_MW_Stn	11:00 AM	-
		018es01874:_ME_Stn	-	12:00 PM
		018es01874:_MW_Stn	11:00 AM	-
		018es01926:_ME_Stn	-	12:00 PM
		018es01926:_MW_Stn	11:00 AM	-
		018es02027:_ME_O_1	-	1:00 PM
		018es02027:_ME_Stn	-	12:00 PM
		018es02027:_MW_O_1	11:00 AM	-
		018es02027:_MW_Stn	11:00 AM	-
		018es02027:_MW_X_1	11:00 AM	-
SR 99	1 of 5	099es02316:_MS_X_2	11:00 AM	-
		099es02316:_MS_X_1	11:00 AM	-
		099es02375:_MS_Stn	11:00 AM	-
		099es02375:_MN_X_1	5:00 AM	9:00 PM
		099es02375:_MN_X_2	-	9:00 PM
		099es02427:_MS_Stn	11:00 AM	-
	2 of 5	099es02465:_MN_X_1	-	1:00 PM
		099es02465:_MS_Stn	11:00 AM	-
		099es02465:_CN_X_1	5:00 AM	1:00 PM
		099es02465:_CS__1	11:00 AM	-
		099es02494:_CN_O_1	11:00 AM	-
		099es02494:_CN__1	11:00 AM	12:00 PM
		099es02494:_MS_Stn	11:00 AM	-

		099es02494:_CS_O_1	11:00 AM	-
		099es02494:_CS_X_1	11:00 AM	-
		099es02545:_MN_O_1	11:00 AM	-
		099es02545:_MS_Stn	11:00 AM	-
		099es02585:_MS_Stn	11:00 AM	-
		099es02585:_MS_X_1	11:00 AM	-
	4 of 5	099es02951:_MS_Stn	11:00 AM	-
		099es03052:_MS_O_1	11:00 AM	-
		099es03052:_MS_Stn	11:00 AM	-
	5 of 5	099es03271:_MN_O_1	11:00 AM	-
		099es03271:_MS_O_1	11:00 AM	-
SR 167	1 of 6	167es01127:_MN_Stn	-	1:00 PM
		167es01127:_MNH_3	5:00 AM	1:00 PM
		167es01127:_MS_Stn	11:00 AM	1:00 PM
		167es01169:_MN_Stn	-	1:00 PM
		167es01169:_MNH_3	5:00 AM	1:00 PM
		167es01169:_MS_Stn	11:00 AM	1:00 PM
		167es01215:_MN_Stn	-	1:00 PM
		167es01215:_MNH_3	5:00 AM	1:00 PM
		167es01215:_MN_X_1	5:00 AM	1:00 PM
		167es01215:MMS_Stn	11:00 AM	1:00 PM
		167es01215:_MSH_3	11:00 AM	-
		167es01215:_MS_P_1	11:00 AM	1:00 PM
		167es01245:MMN_Stn	-	1:00 PM
		167es01245:_MNH_3	5:00 AM	1:00 PM
		167es01245:_MS_Stn	11:00 AM	1:00 PM
		167es01245:_MSH_3	11:00 AM	-
		167es01245:_MS_X_1	11:00 AM	-
		167es01287:_MN_Stn	-	1:00 PM
		167es01287:_MNH_3	5:00 AM	1:00 PM
		167es01287:_MS_Stn	11:00 AM	1:00 PM
		167es01287:_MSH_3	11:00 AM	-
	2 of 6	167es01327:_MN_Stn	-	1:00 PM
		167es01327:_MNH_3	5:00 AM	1:00 PM
		167es01327:_MS_Stn	11:00 AM	1:00 PM
		167es01327:_MSH_3	11:00 AM	-
		167es01375:_MN_Stn	-	1:00 PM
		167es01375:_MNH_3	5:00 AM	1:00 PM
		167es01375:_MN_X_1	11:00 AM	1:00 PM
		167es01375:MMS_Stn	11:00 AM	1:00 PM
		167es01375:_MSH_3	11:00 AM	-
		167es01375:_MSHP_1	11:00 AM	-
		167es01375:_MS_P_2	11:00 AM	12:00 PM
		167es01375:_MS_P_3	11:00 AM	1:00 PM
		167es01375:_MSHP_4	11:00 AM	-
		167es01375:_MS_X_1	11:00 AM	-

	167es01431:_MN_Stn	5:00 AM	1:00 PM
	167es01431:_MNH_3	5:00 AM	-
	167es01431:_MN_O_1	11:00 AM	-
	167es01431:_MN_O_2	11:00 AM	-
	167es01431:_MS_Stn	11:00 AM	1:00 PM
	167es01431:_MSH_4	11:00 AM	-
	167es01431:AME_X_1	11:00 AM	-
	167es01476:_MN_Stn	11:00 AM	1:00 PM
	167es01476:_MNH_4	5:00 AM	1:00 PM
	167es01476:_MS_Stn	11:00 AM	-
	167es01476:_MSH_3	11:00 AM	-
	167es01476:_MS_X_1	11:00 AM	-
	167es01535:_MN_Stn	11:00 AM	1:00 PM
	167es01535:_MNH_3	11:00 AM	1:00 PM
	167es01535:_MS_Stn	11:00 AM	-
	167es01535:_MSH_4	11:00 AM	-
	167es01565:_MS_P_1	11:00 AM	-
	167es01565:_MS_P_2	11:00 AM	1:00 PM
	167es01565:_MSHP_2	11:00 AM	-
	167es01586:MMN_Stn	-	1:00 PM
	167es01586:_MNH_3	5:00 AM	1:00 PM
	167es01586:_MN_P_1	11:00 AM	-
	167es01586:_MNHP_1	5:00 AM	1:00 PM
	167es01586:_MS_Stn	11:00 AM	-
	167es01586:_MSH_4	11:00 AM	-
	167es01586:_MS_X_1	11:00 AM	-
3 of 6	167es01628:_MN_Stn	11:00 AM	1:00 PM
	167es01628:_MNH_3	5:00 AM	-
	167es01628:_MS_Stn	11:00 AM	-
	167es01628:_MSH_3	11:00 AM	-
	167es01687:_MN_Stn	11:00 AM	1:00 PM
	167es01687:_MNH_3	5:00 AM	1:00 PM
	167es01687:_MS_Stn	11:00 AM	1:00 PM
	167es01687:_MSH_3	11:00 AM	-
	167es01738:_MN_Stn	11:00 AM	1:00 PM
	167es01738:_MNH_3	5:00 AM	1:00 PM
	167es01738:_MS_Stn	11:00 AM	1:00 PM
	167es01738:_MSH_3	11:00 AM	-
	167es01784:MMS_Stn	11:00 AM	1:00 PM
	167es01784:_MSH_3	11:00 AM	-
	167es01784:_MS_P_1	11:00 AM	12:00 PM
	167es01784:_MS_X_1	11:00 AM	-
	167es01799:MMN_Stn	5:00 AM	1:00 PM
	167es01799:_MNH_3	5:00 AM	1:00 PM
	167es01799:_MN_P_1	11:00 AM	-
	167es01799:_MNHP_1	-	1:00 PM

	167es01799:_MN_X_1	11:00 AM	-
	167es01849:_MN_Stn	-	1:00 PM
	167es01849:_MNH_3	5:00 AM	1:00 PM
	167es01849:_MS_Stn	11:00 AM	1:00 PM
	167es01849:_MSH_3	11:00 AM	-
4 of 6	167es01901:_MN_Stn	-	1:00 PM
	167es01901:_MNH_3	5:00 AM	1:00 PM
	167es01901:_MS_Stn	11:00 AM	1:00 PM
	167es01901:_MSH_3	11:00 AM	-
	167es01948:MMS_Stn	11:00 AM	1:00 PM
	167es01948:_MSH_3	11:00 AM	-
	167es01948:_MS_P_1	11:00 AM	-
	167es01948:_MS_P_2	11:00 AM	12:00 PM
	167es01948:_MSHP_3	11:00 AM	-
	167es01948:_MS_X_1	11:00 AM	-
	167es01974:MMN_Stn	5:00 AM	1:00 PM
	167es01974:_MNH_3	5:00 AM	1:00 PM
	167es01974:_MN_P_1	11:00 AM	-
	167es01974:_MNHP_1	-	1:00 PM
	167es02019:_MN_Stn	-	1:00 PM
	167es02019:_MNH_3	5:00 AM	1:00 PM
	167es02019:_MS_Stn	11:00 AM	1:00 PM
	167es02019:_MSH_3	11:00 AM	-
	167es02068:_MN_Stn	-	1:00 PM
	167es02068:_MNH_3	5:00 AM	1:00 PM
	167es02068:_MS_Stn	11:00 AM	1:00 PM
	167es02068:_MSH_3	11:00 AM	-
	167es02129:_MN_X_1	-	1:00 PM
	167es02129:MMS_Stn	11:00 AM	1:00 PM
	167es02129:_MSH_3	11:00 AM	-
	167es02129:_MS_P_1	11:00 AM	-
	167es02139:MMN_Stn	-	1:00 PM
	167es02139:_MNH_3	5:00 AM	1:00 PM
	167es02139:_MN_P_1	11:00 AM	-
	167es02139:_MNHP_1	-	1:00 PM
	167es02139:_MS_X_1	11:00 AM	-
5 of 6	167es02189:_MN_Stn	11:00 AM	1:00 PM
	167es02189:_MNH_3	5:00 AM	1:00 PM
	167es02189:_MS_Stn	11:00 AM	1:00 PM
	167es02189:_MSH_3	11:00 AM	-
	167es02226:MMS_Stn	11:00 AM	1:00 PM
	167es02226:_MSH_3	11:00 AM	-
	167es02226:_MSHP_1	11:00 AM	-
	167es02226:_MS_P_2	-	12:00 PM
	167es02234:MMN_Stn	11:00 AM	1:00 PM
	167es02234:_MNH_3	5:00 AM	1:00 PM

		167es02234:_MN_P_1	11:00 AM	-
		167es02293:_MN_Stn	11:00 AM	1:00 PM
		167es02293:_MNH_3	5:00 AM	1:00 PM
		167es02293:_MS_Stn	11:00 AM	1:00 PM
		167es02293:_MSH_3	11:00 AM	-
		167es02342:_MN_Stn	11:00 AM	1:00 PM
		167es02342:_MNH_3	11:00 AM	1:00 PM
		167es02342:_MS_Stn	11:00 AM	1:00 PM
		167es02342:_MSH_3	11:00 AM	-
		167es02390:_MN_Stn	11:00 AM	1:00 PM
		167es02390:_MNH_3	5:00 AM	1:00 PM
		167es02390:_MS_Stn	11:00 AM	1:00 PM
		167es02390:_MSH_3	11:00 AM	-
	6 of 6	167es02445:MMS_Stn	11:00 AM	1:00 PM
		167es02445:_MSH_3	11:00 AM	-
		167es02445:_MS_P_1	11:00 AM	-
		167es02445:_MSHP_1	11:00 AM	-
		167es02445:_MS_X_1	11:00 AM	12:00 PM
		167es02461:MMN_Stn	11:00 AM	1:00 PM
		167es02461:_MNH_3	5:00 AM	1:00 PM
		167es02461:_MN_P_1	11:00 AM	-
		167es02461:_MNHP_1	11:00 AM	1:00 PM
		167es02507:_MN_Stn	11:00 AM	12:00 PM
		167es02507:_MS_Stn	11:00 AM	1:00 PM
		167es02507:_MSH_4	11:00 AM	-
		167es02562:_MN_Stn	11:00 AM	1:00 PM
		167es02562:_MS_Stn	11:00 AM	-
		167es02562:_MSH_4	11:00 AM	-
		167es02614:_MN_Stn	11:00 AM	1:00 PM
		167es02614:_MNHX_1	5:00 AM	-
		167es02614:_MN_X_2	11:00 AM	12:00 PM
		167es02614:_MS_Stn	11:00 AM	-
		167es02614:_MS_O_1	11:00 AM	1:00 PM
		167es02614:_MSHO_2	11:00 AM	-
SR 509	3 of 4	509es02902:_MS_Stn	11:00 AM	-
		509es02947:_MS_Stn	11:00 AM	-
		509es02947:_MS_O_1	11:00 AM	-
		509es02947:_MS_X_1	11:00 AM	-
	4 of 4	509es02976:_MN_X_1	11:00 AM	-
		509es02976:_MN_O_1	11:00 AM	-
		509es02976:_MS_Stn	11:00 AM	-
		509es02976:_MSH_3	11:00 AM	-
		509es02976:_MS_X_1	11:00 AM	-
SR 518	2 of 3	518es00228:MME_Stn	11:00 AM	9:00 PM
		518es00228:_ME_P_2	11:00 AM	12:00 PM
		518es00247:_ME_Stn	11:00 AM	1:00 PM

		518es00247:_ME_O_2	11:00 AM	1:00 PM
		518es00247:_ME_O_2	11:00 AM	9:00 PM
		518es00247:_MW_Stn	11:00 AM	-
		518es00247:_MW_X_1	11:00 AM	-
		518es00247:_MW_X_2	11:00 AM	1:00 PM
		518es00247:_MW_X_3	5:00 AM	8:00 PM
		518es00247:_MW_X_4	5:00 AM	8:00 PM
		518es00267:MME_Stn	11:00 AM	1:00 PM
		518es00267:_ME_P_1	12:00 AM	-
		518es00267:_ME_P_2	11:00 AM	12:00 PM
	3 of 6	518es00300:_ME_Stn	11:00 AM	1:00 PM
		518es00341:_ME_Stn	11:00 AM	1:00 PM
		518es00341:_ME_X_1	11:00 AM	12:00 PM
		518es00341:_MW_Stn	-	1:00 PM
		518es00341:_MW_O_1	11:00 AM	-
SR 520	1 of 6	520es00028:_MW_Stn	11:00 AM	12:00 PM
		520es00028:_MEHP_3	-	12:00 PM
		520es00104:_ME_X_1	11:00 AM	-
		520es00194:_MW_Stn	11:00 AM	-
		520es00241:_MW_Stn	11:00 AM	-
		520es00288:_MW_Stn	11:00 AM	-
		520es00344:_MW_Stn	11:00 AM	-
		520es00398:_ME_Stn	11:00 AM	-
		520es00398:_MW_Stn	11:00 AM	-
	2 of 6	520es00448:_ME_X_1	11:00 AM	-
		520es00448:MMW_Stn	11:00 AM	-
		520es00448:_MW_P_1	11:00 AM	-
		520es00468:_MW_Stn	11:00 AM	-
		520es00492:_MW_Stn	11:00 AM	-
		520es00514:_MW_Stn	11:00 AM	-
		520es00526:_MW_Stn	11:00 AM	-
	3 of 6	520es00585:_MW_P_2	11:00 AM	-
		520es00616:MMW_Stn	11:00 AM	-
	4 of 6	520es00684:_ME_X_1	11:00 AM	-
		520es00684:_MW_X_1	11:00 AM	-
		520es00684:_MW_X_2	11:00 AM	12:00 PM
		520es00714:_MW_Stn	11:00 AM	-
		520es00746:_MEH__1	11:00 AM	-
		520es00746:_ME_X_1	-	12:00 PM
		520es00746:_MW_P_1	11:00 AM	1:00 PM
		520es00746:_MW_P_2	11:00 AM	12:00 PM
		520es00798:_ME_Stn	11:00 AM	-
		520es00798:_MEH__1	11:00 AM	-
		520es00798:_MWH__1	11:00 AM	-
		520es00861:_MWH__1	11:00 AM	-
	5 of 6	520es00911:_MWH__1	11:00 AM	-

		520es00911:_MW_P_3	11:00 AM	-
		520es00911:_MWH_P_4	11:00 AM	-
		520es00935:_ME_P_1	11:00 AM	-
		520es00972:_MWH_2	11:00 AM	-
		520es01001:MMW_Stn	-	12:00 PM
		520es01001:_MWH_1	11:00 AM	-
		520es01001:_CW_P_2	11:00 AM	-
		520es01001:_CW_P_3	11:00 AM	-
		520es01001:_CW_X_1	-	12:00 PM
		520es01031:MME_Stn	11:00 AM	-
		520es01031:_MEH_1	11:00 AM	-
		520es01031:_CE_P_2	11:00 AM	-
		520es01031:_CE_P_3	11:00 AM	-
		520es01067:_MW_X_2	-	12:00 PM
		520es01091:MME_Stn	11:00 AM	-
		520es01091:_MEH_1	11:00 AM	-
		520es01091:_ME_P_2		
	6 of 6	520es01122:_ME_Stn	11:00 AM	-
		520es01167:_ME_Stn	11:00 AM	-
		520es01167:MMW_Stn	-	12:00 PM
		520es01193:MME_Stn	11:00 AM	-
		520es01193:_MW_Stn	-	12:00 PM
		520es01265:MMW_Stn	-	12:00 PM
		520es01265:_MW_P_1	11:00 AM	-
		520es01266:_ME_Stn	11:00 AM	-
		520es01266:_ME_X_1	11:00 AM	-
		520es01266:_ME_X_2	11:00 AM	-
		520es01299:_ME_Stn	11:00 AM	-
		520es01299:_MW_Stn	-	12:00 PM
SR 522	1 of 5	522es00720:UMW_Stn	11:00 AM	-
	3 of 5	522es01326:_MW_Stn	-	12:00 PM
		522es01326:_ME_Stn	11:00 AM	-
		522es01400:_MW_Stn	-	12:00 PM
		522es01400:_MW_X_1	-	12:00 PM
		522es01400:_ME_O_1	11:00 AM	-
		522es01400:_ME_Stn	11:00 AM	-
		522es01400:_ME_X_1	11:00 AM	-
		522es01400:_ME_X_2	11:00 AM	-
	4 of 5	522es01840:_MW_P_1	-	12:00 PM
		522es01840:_MW_P_2	-	12:00 PM
		522es01840:UME_Stn	11:00 AM	-
		522es01895:_ME_X_1	11:00 AM	-
		522es01895:_ME_P_1	3:00 AM	-
		522es01895:_ME_P_2	11:00 AM	-
	5 of 5	522es02030:_ME__1	11:00 PM	-
		522es02086:_ME_Stn	11:00 AM	-

		522es02135:_ME_Stn	11:00 AM	-
		522es02187:_ME_Stn	11:00 AM	-
		522es02237:_ME_Stn	11:00 AM	-
		522es02289:_MW_O_1	-	12:00 PM
		522es02289:_ME_Stn	11:00 AM	-
		522es02333:_ME_Stn	11:00 AM	-
		522es02333:_ME_O_1	11:00 AM	-
		522es02381:_ME_Stn	11:00 AM	-
		522es02432:_ME_Stn	11:00 AM	-
		522es02432:_ME_X_1	11:00 AM	-
SR 525	1 of 2	525es00056:_MN_Stn	11:00 AM	-
		525es00056:_MS_O_1	11:00 AM	-
		525es00096:_MN_Stn	11:00 AM	-
		525es00096:_MN_O_1	11:00 AM	-
		525es00096:_MN_X_1	11:00 AM	-
		525es00096:_MS_X_1	11:00 AM	-
		525es00142:_MN_Stn	11:00 AM	-
		525es00187:_MN_Stn	11:00 AM	-
	2 of 2	525es00252:_MN_Stn	11:00 AM	-
		525es00252:_MN_O_1	11:00 AM	-
		525es00252:_MN_X_1	11:00 AM	-
		525es00285:_MN_Stn	11:00 AM	-
		525es00285:_MS_X_1	11:00 AM	-
SR 526	2 of 2	526es00357:_ME_Stn	11:00 AM	-
		526es00357:_MW_Stn	5:00 AM	1:00 PM
		526es00357:_MW_X_1	11:00 AM	-
		526es00357:_MW_X_2	11:00 AM	-
		526es00357:_MW_X_3	11:00 AM	-
SR 599	1 of 2	599es00045:_MS_O_1	11:00 AM	-
		599es00045:_MS_Stn	11:00 AM	-
	2 of 2	599es00116:_MS_Stn	11:00 AM	-
		599es00169:_MN_X_1	5:00 AM	1:00 PM
		599es00169:_MS_O_1	11:00 AM	-
		599es00169:_MS_Stn	11:00 AM	-
US 2	1 of 2	002es00360:_MW_O_1	11:00 AM	-
		002es00360:_ME_Stn	11:00 AM	-
		002es00360:_ME_X_1	11:00 AM	-
		002es00411:_ME_Stn	11:00 AM	-
		002es00411:_ME_O_1	11:00 AM	-
		002es00504:_MW_Stn	11:00 AM	-
		002es00504:_ME_O_1	-	1:00 PM
		002es00504:_MW_O_1	-	12:00 PM
		002es00504:_MW_X_1	11:00 AM	-
		2 of 2	002es01429:_MW_Stn	11:00 AM
	002es01429:_ME_Stn		11:00 AM	-
	002es02430:_MW__1		11:00 AM	-